



# Service

This manual is to be used by qualified appliance technicians only. Maytag does not assume any responsibility for property damage or personal injury for improper service procedures done by an unqualified person.

This Base Manual covers general information  
Refer to individual Technical Sheet  
for information on specific models

This manual includes, but is  
not limited to the following:

## Amana

AFI2237AE\*  
AFI2538AE\*  
AFD25BCZX\*  
AFD25WBZX\*

## Maytag

MFI2067AE\*  
MFI2266AE\*  
MFI2568AE\*

# Ice and Water Bottom Mount Refrigerators



# Important Information

## Important Notices for Servicers and Consumers

Maytag will not be responsible for personal injury or property damage from improper service procedures. Pride and workmanship go into every product to provide our customers with quality products. It is possible, however, that during its lifetime a product may require service. Products should be serviced only by a qualified service technician who is familiar with the safety procedures required in the repair and who is equipped with the proper tools, parts, testing instruments and the appropriate service information. **IT IS THE TECHNICIANS RESPONSIBILITY TO REVIEW ALL APPROPRIATE SERVICE INFORMATION BEFORE BEGINNING REPAIRS.**



### **WARNING**

To avoid risk of severe personal injury or death, disconnect power before working/servicing on appliance to avoid electrical shock.

To locate an authorized servicer, please consult your telephone book or the dealer from whom you purchased this product. For further assistance, please contact:

### Customer Service Support Center

CAIR Center

<u>Web Site</u>	<u>Telephone Number</u>
WWW.AMANA.COM .....	1-800-843-0304
WWW.JENNAIR.COM .....	1-800-536-6247
WWW.MAYTAG.COM .....	1-800-688-9900
CAIR Center in Canada .....	1-800-688-2002
Amana Canada Product .....	1-866-587-2002

### Recognize Safety Symbols, Words, and Labels



### **DANGER**

**DANGER**—Immediate hazards which **WILL** result in severe personal injury or death.



### **WARNING**

**WARNING**—Hazards or unsafe practices which **COULD** result in severe personal injury or death.



### **CAUTION**

**CAUTION**—Hazards or unsafe practices which **COULD** result in minor personal injury, product or property damage.

# Table of Contents

Important Information .....	2	Water Dispenser Facade .....	31
Product Design .....	4	Low Voltage Board .....	31
Component Testing .....	5	Chute Extension / Yoke Assembly .....	31
Service Procedures .....	10	Ice Box Compartment	
Service Equipment .....	10	Ice Bin Assembly .....	31
Drier Replacement .....	10	Icemaker Assembly .....	31
Refrigerant Precautions .....	11	Ice Box Fan .....	31
Line Piercing Valves .....	11	Auger Motor .....	31
Open Lines .....	11	Solenoid .....	32
Compressor Operational Test .....	11	Damper .....	32
Dehydrating Sealed Refrigeration System .....	12	Ice Box Thermistor .....	32
Leak Testing .....	12	Freezer Compartment	
Testing Systems Containing a		Freezer Thermistor .....	32
Refrigerant Charge .....	12	Light Socket .....	32
Testing Systems Containing		Light Switch .....	32
No Refrigerant Charge .....	12	Freezer Back Panel .....	33
Restrictions .....	13	Evaporator Fan and Evaporator Motor .....	33
Symptoms .....	13	Defrost Terminator (thermostat) .....	33
Testing for Restrictions .....	13	Defrost Heater .....	33
Evacuation and Charging .....	14	Evaporator Removal .....	33
Evacuation .....	14	Drawer Assembly .....	34
Charging .....	15	Drawer Rails .....	34
Refrigerant Charge .....	15	Rack and Pinion Gear .....	34
HFC134a Service Information .....	16	Bottom of Cabinet	
Health, Safety, and Handling .....	16	Front roller assembly .....	34
Comparison of CFC12 and HFC134a Properties .....	16	Rear roller assembly.....	34
Replacement Service Compressor .....	17	Machine Compartment	
Compressor Testing Procedures .....	17	Condenser Fan and Fan motor .....	34
Brazing .....	17	Compressor .....	34
Refrigerant Flow 20, 22, 25 cu. ft .....	18	Overload/Relay/Capacitor .....	35
Cabinet Air Flow 20, 22, 25 cu. ft .....	19	Condensate Drain Pan .....	35
20, 22, 25 cu. ft Machine Compartment		Condensate Drain Tube .....	35
Air Flow Diagram .....	20	Condenser Removal .....	35
Water Dispenser Flow .....	21	Cabinet Back	
Water Flow Schematic .....	22	High Voltage Board .....	35
Typical External Sweat Pattern.....	23	Control Board (Fully Electronic)	
Troubleshooting Chart.....	24	Programming Mode .....	36
System Diagnosis .....	27	Defrost Operation .....	36
Disassembly Procedures		Forced Defrost Mode .....	36
Door Removal		Service Test Mode .....	37
Fresh Food Doors .....	30	Show Room Mode .....	40
Freezer Drawer .....	30	Appendix A	
Refrigerator Compartment		Owner's Manual .....	A-1
Upper Light Bulb Cover .....	30		
Light Bulb Assembly .....	30		
Light Bulb Sockets .....	30		
Light Switches .....	30		
Fresh Food Thermistor .....	31		
Water Tank .....	31		

# Product Design



## WARNING

To avoid risk of electrical shock, personal injury, or death, disconnect electrical power source to unit, unless test procedures require power to be connected. Discharge capacitor through a resistor before attempting to service. Ensure all ground wires are connected before certifying unit as repaired and/or operational.

### Refrigeration System

Compressor forces high temperature vapor into fan cooled tube and wire condenser where vapor is cooled and condensed into high pressure liquid by circulation of air across condenser coil. (See Refrigerant Flow Diagram, page 18)

High pressure liquid passes into post-condenser loop which helps to prevent condensation around freezer compartment opening and through molecular sieve drier and into capillary tube. Small inside diameter of capillary offers resistance, decreasing pressure and temperature of liquid discharged into evaporator. Capillary diameter and length is carefully sized for each system.

Capillary enters evaporator at top front. Combined liquid and saturated gas flows through front to bottom of coil and into suction line. Aluminium tube evaporator coil is located in freezer compartment where circulating evaporator fan moves air through coil and into fresh food compartment.

Large surface of evaporator allows heat to be absorbed from both fresh food and freezer compartments by airflow over evaporator coil causing some of the liquid to evaporate. Temperature of evaporator tubing near end of running cycle may vary from -13°F to -25°F.

Saturated gas is drawn off through suction line where superheated gas enters compressor. To raise temperature of gas, suction line is placed in heat exchange with capillary.

### Temperature Controls

Freezer compartment temperature is regulated by air sensing thermistor at top front of freezer compartment which actuates compressor. Control should be set to maintain freezer temperature between 0°F to -2°F.

Fresh food compartment temperature is regulated by an air damper control governing amount of refrigerated air entering fresh food compartment from freezer. Fresh food compartment temperature should be between 38°F and 40°F.

Evaporator and Ice Box Fans are multiple speed low voltage fans that change speeds depending on conditions changing in refrigerator.

### Defrost System

#### Fully Electronic Defrost System

The Control Board adapts the compressor run time between defrosts to achieve optimum defrost intervals by monitoring the length of time the defrost heater is on.

After initial power up, defrost interval is 4 hours compressor run time. Defrost occurs immediately after the 4 hours.

**Note:** Once unit is ready to defrost there is a 4 minute wait time prior to the beginning of the defrost cycle.

# Component Testing



## WARNING

To avoid risk of electrical shock, personal injury, or death, disconnect electrical power source to unit, unless test procedures require power to be connected. Discharge capacitor through a resistor before attempting to service. Ensure all ground wires are connected before certifying unit as repaired and/or operational.



Component	Description	Test Procedures
<div data-bbox="186 472 332 630" data-label="Image"> </div> <p data-bbox="162 409 284 430">Compressor</p>	<p data-bbox="350 409 743 619">When compressor electrical circuit is energized, the start winding current causes relay to heat. After an amount of starting time, the start winding circuit turns off. The relay will switch off the start winding circuit even though compressor has not started (for example, when attempting to restart after momentary power interruption).</p> <p data-bbox="350 640 743 766">With “open” relay, compressor will not start because there is little or no current to start windings. Overload protection will open due to high locked rotor run winding current.</p> <p data-bbox="350 787 743 913">With “shorted” relay or capacitor, compressor will start and overload protector will quickly open due to high current of combined run and start windings.</p> <p data-bbox="350 934 743 1018">With open or weak capacitor, compressor will start and run as normal but will consume more energy.</p>	<p data-bbox="750 409 909 430"><b>Resistance test</b></p> <ol data-bbox="750 430 1515 577" style="list-style-type: none"> <li>1. Disconnect power to unit.</li> <li>2. Discharge capacitor by shorting across terminals with a resistor for 1 minute.</li> </ol> <p data-bbox="750 472 1291 504"><b>NOTE:</b> (Some compressors do not have a run capacitor.)</p> <ol data-bbox="750 504 1515 672" style="list-style-type: none"> <li>3. Remove leads from compressor terminals.</li> <li>4. Set ohmmeter to lowest scale.</li> <li>5. Check for resistance between             <ul data-bbox="844 567 1185 619" style="list-style-type: none"> <li>Terminals “S” and “C”, start winding</li> <li>Terminals “R” and “C”, run winding</li> </ul> </li> </ol> <p data-bbox="795 619 1515 672">If either compressor winding reads open (infinite or very high resistance) or dead short (0 ohms), replace compressor.</p> <p data-bbox="750 682 876 703"><b>Ground test</b></p> <ol data-bbox="750 703 1515 850" style="list-style-type: none"> <li>1. Disconnect power to refrigerator.</li> <li>2. Discharge capacitor, if present, by shorting terminals through a resistor.</li> <li>3. Remove compressor leads and use an ohmmeter set on highest scale.</li> <li>4. Touch one lead to compressor body (clean point of contact) and other probe to each compressor terminal.             <ul data-bbox="779 829 1461 850" style="list-style-type: none"> <li>• If reading is obtained, compressor is grounded and must be replaced.</li> </ul> </li> </ol> <p data-bbox="750 861 901 882"><b>Operation test</b></p> <p data-bbox="750 882 1515 934">If voltage, capacitor, overload, and motor winding tests do not show cause for failure, perform the following test:</p> <ol data-bbox="750 934 1515 1207" style="list-style-type: none"> <li>1. Disconnect power to refrigerator.</li> <li>2. Discharge capacitor by shorting capacitor terminals through a resistor.</li> <li>3. Remove leads from compressor terminals.</li> <li>4. Wire a test cord to power switch.</li> <li>5. Place time delayed fuse with UL rating equal to amp rating of motor in test cord socket. (Refer to Technical Data Sheet)</li> <li>6. Remove overload and relay.</li> <li>7. Connect start, common and run leads of test cord on appropriate terminals of compressor.</li> <li>8. Attach capacitor leads of test cord together. If capacitor is used, attach capacitor lead to a known good capacitor of same capacity.</li> </ol> <div data-bbox="966 1207 1299 1564" data-label="Diagram"> <p data-bbox="1047 1564 1226 1585">Test configuration</p> </div> <ol data-bbox="750 1596 1515 1900" style="list-style-type: none"> <li>9. Plug test cord into multimeter to determine start and run wattage and to check for low voltage, which can also be a source of trouble indications.</li> <li>10. With power to multimeter, press start cord switch and release.             <ul data-bbox="779 1669 1515 1900" style="list-style-type: none"> <li>• If compressor motor starts and draws normal wattage, compressor is okay and trouble is in capacitor, relay/overload, freezer temperature control, or elsewhere in system.</li> <li>• If compressor does not start when direct wired, recover refrigerant at high side. After refrigerant is recovered, repeat compressor direct wire test. If compressor runs after recovery but would not run when direct wired before recover, a restriction in sealed system is indicated.</li> <li>• If compressor does not run when wired direct after recovery, replace faulty compressor.</li> </ul> </li> </ol>

# Component Testing

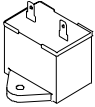

## WARNING

To avoid risk of electrical shock, personal injury, or death, disconnect electrical power source to unit, unless test procedures require power to be connected. Discharge capacitor through a resistor before attempting to service. Ensure all ground wires are connected before certifying unit as repaired and/or operational.



Component	Description	Test Procedures
<p>Capacitor</p> 	<p>Run capacitor connects to relay terminal 3 and L side of line.</p> <p>Some compressors do not require a run capacitor; refer to the Technical Data Sheet for the unit being serviced.</p>	<div style="border: 1px solid black; padding: 5px; margin-bottom: 10px;">  <h3 style="margin: 0;">WARNING</h3> <p>To avoid electrical shock which can cause severe personal injury or death, discharge capacitor through a resistor before handling.</p> </div> <ol style="list-style-type: none"> <li>1. Disconnect power to refrigerator.</li> <li>2. Remove capacitor cover and disconnect capacitor wires.</li> <li>3. Discharge capacitor by shorting across terminals with a resistor for 1 minute.</li> <li>4. Check resistance across capacitor terminals with ohmmeter set on "X1K" scale. <ul style="list-style-type: none"> <li>• <b>Good</b>—needle swings to 0 ohms and slowly moves back to infinity.</li> <li>• <b>Open</b>—needle does not move. Replace capacitor.</li> <li>• <b>Shorted</b>—needle moves to zero and stays. Replace capacitor.</li> <li>• <b>High resistance leak</b>—needle jumps toward 0 and then moves back to constant high resistance (not infinity).</li> </ul> </li> </ol>
<p>Condenser</p>	<p>Condenser is a tube and wire construction located in machine compartment.</p> <p>Condenser is on high pressure discharge side of compressor. Condenser function is to transfer heat absorbed by refrigerant to ambient.</p> <p>Higher pressure gas is routed to condenser where, as gas temperature is reduced, gas condenses into a high pressure liquid state. Heat transfer takes place because discharged gas is at a higher temperature than air that is passing over condenser. It is very important that adequate air flow over condenser is maintained.</p> <p>Condenser is air cooled by condenser fan motor. If efficiency of heat transfer from condenser to surrounding air is impaired, condensing temperature becomes higher. High liquid temperature means liquid will not remove as much heat during boiling in evaporator as under normal conditions. This would be indicated by higher than normal head pressures, long run time, and high wattage. Remove any lint or other accumulation, that would restrict normal air movement through condenser.</p> <p>From condenser the refrigerant flows into a post condenser loop which helps control exterior condensation on flange, center mullion, and around freezer door. Refrigerant flows through the drier to evaporator and into compressor through suction line.</p>	<p>Leaks in condenser can usually be detected by using an electronic leak detector or soap solution. Look for signs of compressor oil when checking for leaks. A certain amount of compressor oil is circulated with refrigerant.</p> <p>Leaks in post condenser loop are rare because loop is a one-piece copper tube.</p> <p>For minute leaks</p> <ol style="list-style-type: none"> <li>1. Separate condenser from rest of refrigeration system and pressurize condenser up to a maximum of 235 PSI with a refrigerant and dry nitrogen combination.</li> <li>2. Recheck for leaks.</li> </ol> <div style="border: 1px solid black; padding: 5px; margin-top: 10px;">  <h3 style="margin: 0;">WARNING</h3> <p>To avoid severe personal injury or death from sudden eruption of high pressures gases, observe the following: Protect against a sudden eruption if high pressures are required for leak checking. Do not use high pressure compressed gases in refrigeration systems without a reliable pressure regulator and pressure relief valve in the lines.</p> </div>

# Component Testing

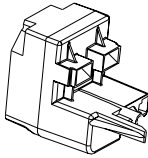

## WARNING

To avoid risk of electrical shock, personal injury, or death, disconnect electrical power source to unit, unless test procedures require power to be connected. Discharge capacitor through a resistor before attempting to service. Ensure all ground wires are connected before certifying unit as repaired and/or operational.



Component	Description	Test Procedures												
Overload / Relay 	<p>When voltage is connected and relay is cool, current passes through relay to start winding.</p> <p>After a short time, current heats the resistor in relay and resistance will rise blocking current flow through relay.</p> <p>Start winding remains in the circuit through run capacitor.</p> <p>Solid state relay plugs directly on compressor start and run terminals. Relay terminals 2 and 3 are connected within relay. Run capacitor is connected to relay terminal 3. L2 side of 120 VAC power is connected to relay terminal 2.</p>	<ol style="list-style-type: none"> <li>1. Disconnect power to the refrigerator.</li> <li>2. Remove relay cover and disconnect leads.</li> <li>3. Check resistance across terminals 2 and 3 with an ohmmeter: Normal = 3 to 12 ohms Shorted = 0 ohms Open = infinite ohms</li> </ol>												
Control board	See "Control Board" section for troubleshooting information.													
Evaporator fan motor	Evaporator fan moves air across evaporator coil and throughout refrigerator cabinet.	<ol style="list-style-type: none"> <li>1. Use Control board testing to check operation of motor.</li> <li>2. If fan motor does not operate, check for voltage at motor leads.</li> <li>3. Replace motor if power is present.</li> <li>4. Replace Control board if no power.</li> </ol>												
Ice Box fan motor	Ice Box fan moves air across Ice Maker and throughout refrigerator cabinet.	<ol style="list-style-type: none"> <li>1. Use Control board testing to check operation of motor.</li> <li>2. If fan motor does not operate check for voltage at motor leads.</li> <li>3. Replace motor if power is present.</li> <li>4. Replace Control board if no power.</li> </ol>												
Right Refrigerator & Freezer light switch	Single pole, single throw switch completes circuit for light when door is open.	<p>Check resistant across terminals.</p> <table border="0"> <tr> <td>Switch arm depressed</td> <td></td> </tr> <tr> <td>"C" and "NC" terminals</td> <td>Open</td> </tr> <tr> <td>Switch arm up</td> <td></td> </tr> <tr> <td>"C" and "NC" terminals</td> <td>Closed</td> </tr> </table>	Switch arm depressed		"C" and "NC" terminals	Open	Switch arm up		"C" and "NC" terminals	Closed				
Switch arm depressed														
"C" and "NC" terminals	Open													
Switch arm up														
"C" and "NC" terminals	Closed													
Ice maker water valve	<p>Controls water flow to the ice maker.</p> <p>Controlled by ice maker.</p> <p>See "Control Board" section for further testing information.</p>	Check resistance across coil windings.												
Evaporator heater (defrost)	Activated when defrost thermostat control board completes circuit through heater.	<p>Check resistance across heater.</p> <p>To check defrost system :</p> <ol style="list-style-type: none"> <li>1. Use Control Board testing to check operation of defrost heater.</li> <li>2. If heater does not operate, check defrost thermostat to see if closed.</li> <li>3. If no power to heater, replace control board.</li> </ol>												
Left Refrigerator Light Switch 	Single pole, double throw switch completes circuit for light when door is open.	<p>Check resistant across terminals.</p> <table border="0"> <tr> <td>Switch arm depressed</td> <td></td> </tr> <tr> <td>"C" and "NC" terminals</td> <td>Open</td> </tr> <tr> <td>"C" and "NO" terminals</td> <td>Closed</td> </tr> <tr> <td>Switch arm up</td> <td></td> </tr> <tr> <td>"C" and "NC" terminals</td> <td>Closed</td> </tr> <tr> <td>"C" and "NO" terminals</td> <td>Open</td> </tr> </table>	Switch arm depressed		"C" and "NC" terminals	Open	"C" and "NO" terminals	Closed	Switch arm up		"C" and "NC" terminals	Closed	"C" and "NO" terminals	Open
Switch arm depressed														
"C" and "NC" terminals	Open													
"C" and "NO" terminals	Closed													
Switch arm up														
"C" and "NC" terminals	Closed													
"C" and "NO" terminals	Open													

# Component Testing



## WARNING

To avoid risk of electrical shock, personal injury, or death, disconnect electrical power source to unit, unless test procedures require power to be connected. Discharge capacitor through a resistor before attempting to service. Ensure all ground wires are connected before certifying unit as repaired and/or operational.

Component	Description	Test Procedures
<p>Drier</p> 	<p>Drier is placed at post condenser loop outlet and passes liquified refrigerant to capillary.</p> <p>Desiccant (20) 8 x 12 4AXH - 7 M&gt;S&gt; - Grams</p>	<p><b>Drier must be changed every time the system is opened for testing or compressor replacement.</b></p> <p><b>NOTE:</b> Drier used in R12 sealed system is not interchangeable with drier used in R134a sealed system. Always replace drier in R134a system with Amana part number B2150504.</p> <p>Before opening refrigeration system, recover HFC134a refrigerant for safe disposal.</p> <ol style="list-style-type: none"> <li>1. Cut drier out of system using the following procedure. Do not unbraid drier.</li> <li>2. Applying heat to remove drier will drive moisture into the system.</li> <li>3. Score capillary tube close to drier and break.</li> <li>4. Reform inlet tube to drier allowing enough space for large tube cutter.</li> <li>5. Cut circumference of drier 1/4" below condenser inlet tube joint to drier.</li> <li>6. Remove drier.</li> <li>7. Apply heat trap paste on post condenser tubes to protect grommets from high heat.</li> <li>8. Unbraid remaining part of drier. Remove drier from system.</li> <li>9. Discard drier in safe place. Do not leave drier with customer. If refrigerator is under warranty, old drier must accompany warranty claim.</li> </ol> <div data-bbox="701 863 1442 1024" style="border: 1px solid black; padding: 5px;"> <p style="text-align: center;"> <b>WARNING</b></p> <p>To avoid death or severe personal injury, cut drier at correct location. Cutting drier at incorrect location will allow desiccant beads to scatter. If spilled, completely clean area of beads.</p> </div>
<p>Evaporator</p>	<p>Inner volume of evaporator allows liquid refrigerant discharged from capillary to expand into refrigerant gas.</p> <p>Expansion cools evaporator tube and fin temperature to approximately -20°F transferring heat from freezer section to refrigerant.</p> <p>Passing through suction line to compressor, the refrigerant picks up superheat (a relationship between pressure and temperature that assures complete vaporization of liquid refrigerant) as the result of capillary tube soldered to suction line.</p> <p>Refrigerant gas is pulled through suction line by compressor, completing refrigeration cycle.</p>	<p>Test for leaks in evaporator with electronic leak detector or with soap solution. Compressor oil is circulated with refrigerant; check for oil when checking for leaks.</p> <p>For minute leaks</p> <ol style="list-style-type: none"> <li>1. Separate evaporator from rest of refrigeration system and pressurize evaporator up to a maximum of 140 PSI with a refrigerant and dry nitrogen combination.</li> <li>2. Recheck for leaks.</li> </ol> <div data-bbox="701 1268 1442 1539" style="border: 1px solid black; padding: 5px;"> <p style="text-align: center;"> <b>WARNING</b></p> <p>To avoid severe personal injury or death from sudden eruption of high pressures gases, observe the following:</p> <p>Protect against a sudden eruption if high pressures are required for leak checking.</p> <p>Do not use high pressure compressed gases in refrigeration systems without a reliable pressure regulator and pressure relief valve in the lines.</p> </div>
<p>Thermostat (defrost)</p>	<p>Thermostat is in a series circuit with terminal main control board and defrost heater.</p> <p>Controls the circuit from main control board through defrost thermostat to defrost heater. Opens and breaks circuit when thermostat senses preset high temperature.</p>	<p>Test continuity across terminals.</p> <p>With power off and evaporator coil below freezing, thermostat should show "0" ohms when checked with ohmmeter. See "Heater, evaporator (defrost)" section for additional tests. If evaporator coil is warm, should show 56k ohms with an ohm meter.</p> <p>After defrost thermostat opens, thermostat remains open until end of defrost cycle and refrigerator starts cooling again. Defrost thermostat senses a preset low temperature and resets (closes).</p>



# Component Testing



## WARNING

To avoid risk of electrical shock, personal injury, or death, disconnect electrical power source to unit, unless test procedures require power to be connected. Discharge capacitor through a resistor before attempting to service. Ensure all ground wires are connected before certifying unit as repaired and/or operational.

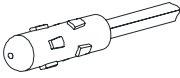
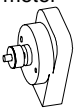
Component	Description	Test Procedures
 Thermistor	Temperature sensing device	Check resistance across leads. Nominal Temperature Resistance 77°F 9,820 - 10182 ohms 36°F 29,198 – 29,788 ohms 0°F 84,561 – 88,011 ohms
 ECM condenser motor	Condenser fan moves cooling air across condenser coil and compressor body.  Condenser fan motor is in parallel circuit with compressor.	<ol style="list-style-type: none"> <li>1. Use control board testing to check operation of motor.</li> <li>2. If motor does not operate check for voltage at motor.</li> <li>3. If no voltage at motor replace control board.</li> </ol>
Electric damper control	Damper control balances the air delivery between refrigerator and freezer compartments providing temperature control for refrigerator. Electrical voltage activates damper control and door closes restricting flow of air from freezer/ ice box compartment to refrigerator compartment.	<ol style="list-style-type: none"> <li>1. Use control board testing to check operation of damper.</li> <li>2. If damper does not operate check for voltage at damper.</li> <li>3. If no voltage at damper replace control board.</li> </ol>
Auger Motor	Auger motor is controlled by Dispenser switch. Depressing dispenser switch activates Auger Motor, Ice Box Solenoid and Door Chute Motor.	<ol style="list-style-type: none"> <li>1. Use control board testing to check operation of motor.</li> <li>2. If motor does not operate check for voltage at motor.</li> <li>3. If no voltage at motor replace control board.</li> </ol>
Ice Box Solenoid	Ice Box Solenoid is controlled by Dispenser switch. Depressing dispenser switch activates Auger Motor, Ice Box Solenoid and Door Chute Motor.	<ol style="list-style-type: none"> <li>1. Use control board testing to check operation of solenoid.</li> <li>2. If motor does not operate check for voltage at motor.</li> <li>3. If no voltage at solenoid replace control board.</li> </ol>
Door Chute Motor	Door chute motor is controlled by Dispenser switch. Depressing dispenser switch activates Auger Motor, Ice Box Solenoid and Door Chute Motor.	<ol style="list-style-type: none"> <li>1. Use control board testing to check operation of motor.</li> <li>2. If motor does not operate check for voltage at motor.</li> <li>3. If no voltage at motor replace control board.</li> </ol>
Dispenser Cavity Heater	Cavity Heater is controlled by Control Board.	<ol style="list-style-type: none"> <li>1. Use control board testing to check operation of heater.</li> <li>2. If heater does not operate check for voltage at heater.</li> <li>3. If no voltage at heater replace Control Board.</li> </ol>
Mullion Heater	Mullion Heater is controlled by Control Board.	<ol style="list-style-type: none"> <li>1. Use control board testing to check operation of heater.</li> <li>2. If heater does not operate check for voltage at heater.</li> <li>3. If no voltage at heater replace Control Board.</li> </ol>

# Service Procedures



## WARNING

To avoid risk of electrical shock, personal injury, or death, disconnect electrical power source to unit, unless test procedures require power to be connected. Discharge capacitor through a 10,000 ohm resistor before attempting to service. Ensure all ground wires are connected before certifying unit as repaired and/or operational.

### Service Equipment

Listed below is equipment needed for proper servicing of HFC134a systems. Verify equipment is confirmed by manufacturer as being compatible with HFC134a and ester oil system.

Equipment must be exclusively used for HFC134a. Exclusive use of equipment only applies to italic items.

- **Evacuation pump**

Check with vacuum pump supplier to verify equipment is compatible for HFC134a. Robinair, Model 15600 2 stage, 6 cubic feet per minute pump is recommended.

- ***Four-way manifold gauge set, with low loss hoses***

- **Leak detector**

- ***Charging cylinder***

- ***Line piercing saddle valve***

(Schroeder valves). Seals must be HFC134a and ester oil compatible. Line piercing valves may be used for diagnosis but are not suitable for evacuation or charging, due to minute holes pierced in tubing. Do not leave mechanical access valves on system.

Valves eventually will leak. Molecules of HFC134a are smaller than other refrigerants and will leak where other refrigerants would not.

- ***Swaging tools***

- ***Flaring tools***

- ***Tubing cutter***

- **Flux**

- **Sil-Fos**

- **Silver solder**

- ***Oil for swaging and flaring***

Use only part # R0157532

- ***Copper tubing***

Use only part # R0174075 and # R0174076

- **Dry nitrogen**

99.5% minimum purity, with -40°F or lower dew point

- **Crimp tool**

- **Tube bender**

- **Micron vacuum gauge**

- ***Process tube adaptor kit***

- **Heat trap paste**

- ***ICI appliance grade HFC134a***

### Drier Replacement

Before opening refrigeration system, recover HFC134a refrigerant for safe disposal.

Every time sealed HFC134a system is repaired, drier filter must be replaced with, part # B2150504.

Cut drier out of system by completing the following steps. Do not unbraid drier filter. Applying heat to remove drier will drive moisture into system.



## WARNING

To avoid risk of severe personal injury or death, cut drier at correct location. Cutting drier at incorrect location will allow desiccant beads to scatter. Completely clean area of beads, if spilled.

1. Score capillary tube close to drier and break.
2. Reform inlet tube to drier allowing enough space for large tube cutter.
3. Cut circumference of drier at 1-1/4", below condenser inlet tube joint to drier.
4. Remove drier.
5. Apply heat trap paste on post condenser tubes to protect grommets from high heat.
6. Unbraid remaining part of drier. Remove drier from system.
7. Discard drier in safe place. Do not leave drier with customer. If refrigerator is under warranty, old drier must accompany warranty claim.

# Service Procedures



## WARNING

To avoid risk of electrical shock, personal injury, or death, disconnect electrical power source to unit, unless test procedures require power to be connected. Discharge capacitor through a 10,000 ohm resistor before attempting to service. Ensure all ground wires are connected before certifying unit as repaired and/or operational.

### Refrigerant Precautions



## WARNING

To avoid risk of personal injury, do not allow refrigerant to contact eyes or skin.



## CAUTION

To avoid risk of property damage, do not use refrigerant other than that shown on unit serial number identification plate.

**NOTE:** All precautionary measures recommended by refrigerant manufacturers and suppliers apply and should be observed.

### Line Piercing Valves

Line piercing valves can be used for diagnosis, but are not suitable for evacuating or charging due to holes pierced in tubing by valves.

**NOTE:** Do not leave line piercing valves on system. Connection between valve and tubing is not hermetically sealed. Leaks will occur.

### Open Lines

During any processing of refrigeration system, never leave lines open to atmosphere. Open lines allow water vapor to enter system, making proper evacuation more difficult.

### Compressor Operational Test

(short term testing only)

If compressor voltage, capacitor, overload, and motor winding tests are successful (do not indicate a fault), perform the following test:

1. Disconnect power to unit.
  2. Discharge capacitor by shorting capacitor terminals through a resistor.
- NOTE:** Not all units have run capacitor.
3. Remove leads from compressor terminals.
  4. Attach test cord to compressor windings.

- Common lead on test cord attaches to C terminal on compressor.
- Start lead on test cord attaches to S terminal on compressor.
- Run lead on test cord attaches to R terminal on compressor.

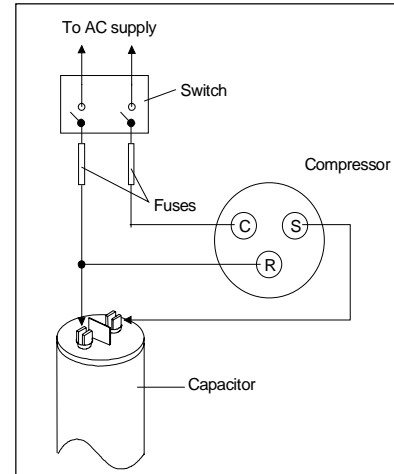

Attaching Capacitor for Compressor Test

5. Connect a known good capacitor into circuit as shown above. For proper capacitor size and rating, see technical data sheet for unit under test.

**NOTE:** Ensure test cord cables and fuses meet specifications for unit under test (see Technical Sheet for unit under test).

6. Replace compressor protector cover securely.
7. Plug test cord into outlet, then press and release start cord switch.



## CAUTION

To avoid risk of damage to compressor windings, immediately disconnect (unplug) test cord from power source if compressor does not start. Damage to compressor windings occurs if windings remain energized when compressor is not running.

If compressor runs when direct wired, it is working properly. Malfunction is elsewhere in system.

If compressor does not start when direct wired, recover system at high side. After the system is recovered, repeat compressor direct wire test.

If compressor runs after system is recovered (but would not operate when wired direct before recovery) a restriction in sealed system is indicated.

If motor does not run when wired direct after recovery, replace faulty compressor.

# Service Procedures



## WARNING

To avoid risk of electrical shock, personal injury, or death, disconnect electrical power source to unit, unless test procedures require power to be connected. Discharge capacitor through a 10,000 ohm resistor before attempting to service. Ensure all ground wires are connected before certifying unit as repaired and/or operational.

### Dehydrating Sealed Refrigeration System

Moisture in a refrigerator sealed system exposed to heat generated by the compressor and motor reacts chemically with refrigerant and oil in the system and forms corrosive hydrochloric and hydrofluoric acids. These acids contribute to breakdown of motor winding insulation and corrosion of compressor working parts, causing compressor failure.

In addition, sludge, a residue of the chemical reaction, coats all surfaces of sealed system, and will eventually restrict refrigerant flow through capillary tube.

To dehydrate sealed system, evacuate system (see paragraph *Evacuation*).

### Leak Testing



## DANGER

To avoid risk of serious injury or death from violent explosions, NEVER use oxygen or acetylene for pressure testing or cleaning out of refrigeration systems. Free oxygen will explode on contact with oil. Acetylene will explode spontaneously when put under pressure.

It is important to check sealed system for refrigerant leaks. Undetected leaks can lead to repeated service calls and eventually result in system contamination, restrictions, and premature compressor failure.

Refrigerant leaks are best detected with halide or electronic leak detectors.

### Testing Systems Containing a Refrigerant Charge

1. Stop unit operation (turn refrigerator off).
2. Holding leak detector exploring tube as close to system tubing as possible, check all piping, joints, and fittings.

**NOTE:** Use soap suds on areas leak detector cannot reach or reliably test.

### Testing Systems Containing No Refrigerant Charge

1. Connect cylinder of nitrogen, through gauge manifold, to process tube of compressor and liquid line strainer.
2. Open valves on nitrogen cylinder and gauge manifold. Allow pressure to build within sealed system.
3. Check for leaks using soap suds.

If a leak is detected in a joint, do not to attempt to repair by applying additional brazing material. Joint must be disassembled, cleaned and rebrazed. Capture refrigerant charge (if system is charged), unbrazed joint, clean all parts, then rebraze.

If leak is detected in tubing, replace tubing. If leak is detected in either coil, replace faulty coil.

# Service Procedures



## WARNING

To avoid risk of electrical shock, personal injury, or death, disconnect electrical power source to unit, unless test procedures require power to be connected. Discharge capacitor through a 10,000 ohm resistor before attempting to service. Ensure all ground wires are connected before certifying unit as repaired and/or operational.

### Restrictions

#### Symptoms

Restrictions in sealed system most often occur at capillary tube or filter drier, but can exist anywhere on liquid side of system.

Restrictions reduce refrigerant flow rate and heat removal rate. Wattage drops because compressor is not circulating normal amount of refrigerants.

Common causes of total restrictions are moisture, poorly soldered joints, or solid contaminants. Moisture freezes at evaporator inlet end of capillary tube. Solid contaminants collect in filter drier.

If restriction is on low side, suction pressure will be in a vacuum and head pressure will be near normal.

If restriction is on high side, suction pressure will be in a vacuum and head pressure will be higher than normal during pump out cycle.

Refrigeration occurs on low pressure side of partial restriction. There will be a temperature difference at the point of restriction. Frost and/or condensation will be present in most cases at the point of restriction. Also, system requires longer to equalize.

Slight or partial restriction can give the same symptoms as refrigerant shortage including lower than normal back pressure, head pressure, wattage, and warmer temperatures.

Total restriction on the discharge side of compressor, when restriction is between compressor and first half of condenser, results in higher than normal head pressure and wattage while low side is being pumped out.

#### Testing for Restrictions

To determine if a restriction exists:

1. Attach gauge and manifold between suction and discharge sides of sealed system.
2. Turn unit on and allow pressure on each side to stabilize. Inspect condenser side of system. Tubing on condenser should be warm and temperature should be equal throughout (no sudden drops at any point along tubing).
  - If temperature of condenser tubing is consistent throughout, go to step 4.
  - If temperature of condenser tubing drops suddenly at any point, tubing is restricted at point of temperature drop (if restriction is severe, frost may form at point of restriction and extend down in direction of refrigerant flow in system). Go to step 5.

3. Visually check system for kinks in refrigeration line which is causing restriction. Correct kink and repeat step 2.
  4. Turn unit off and time how long it takes high and low pressure gauges to equalize:
    - If pressure equalization takes longer than 10 minutes, a restriction exists in the capillary tube or drier filter. Go to step 5.
    - If pressure equalization takes less than 10 minutes, system is not restricted. Check for other possible causes of malfunction.
  5. Recover refrigerant in sealed system.
- NOTE:** Before opening any refrigeration system, capture refrigerant in system for safe disposal.
6. Remove power from unit.



## CAUTION

To avoid risk of personal injury or property damage, take necessary precautions against high temperatures required for brazing.

7. Remove and replace restricted device.
  8. Evacuate sealed system.
  9. Charge system to specification.
- NOTE:** Do not use captured or recycled refrigerant in units. Captured or recycled refrigerant voids any compressor manufacturer's warranty.
- NOTE:** Charge system with exact amount of refrigerant. Refer to unit nameplate for correct refrigerant charge. Inaccurately charged system will cause future problems.

# Service Procedures



## WARNING

To avoid risk of electrical shock, personal injury, or death, disconnect electrical power source to unit, unless test procedures require power to be connected. Discharge capacitor through a 10,000 ohm resistor before attempting to service. Ensure all ground wires are connected before certifying unit as repaired and/or operational.

## Evacuation and Charging



## CAUTION

To avoid risk of fire, sealed refrigeration system must be air free. To avoid risk of air contamination, follow evacuation procedures exactly.

**NOTE:** Before opening any refrigeration system, EPA regulations require refrigerant in system to be captured for safe disposal.

Proper evacuation of sealed refrigeration system is an important service procedure. Usable life and operational efficiency greatly depends upon how completely air, moisture and other non-condensables are evacuated from sealed system.

Air in sealed system causes high condensing temperature and pressure, resulting in increased power requirements and reduced performance.

Moisture in sealed system chemically reacts with refrigerant and oil to form corrosive hydrofluoric and hydrochloric acids. These acids attack motor windings and parts, causing premature breakdown.

Before opening system, evaporator coil must be at ambient temperature to minimize moisture infiltration into system.

### Evacuation

To evacuate sealed refrigeration system:

1. Connect vacuum pump, vacuum tight manifold set with high vacuum hoses, thermocouple vacuum gauge and charging cylinder as shown in illustration. Evacuation should be done through I.D. opening of tubes not through line piercing valve.
2. Connect low side line to compressor process tube.
3. Connect high side line to drier/process tube.
4. Evacuate both simultaneously. With valve "C" and "F" closed, open all other valves and start vacuum pump.

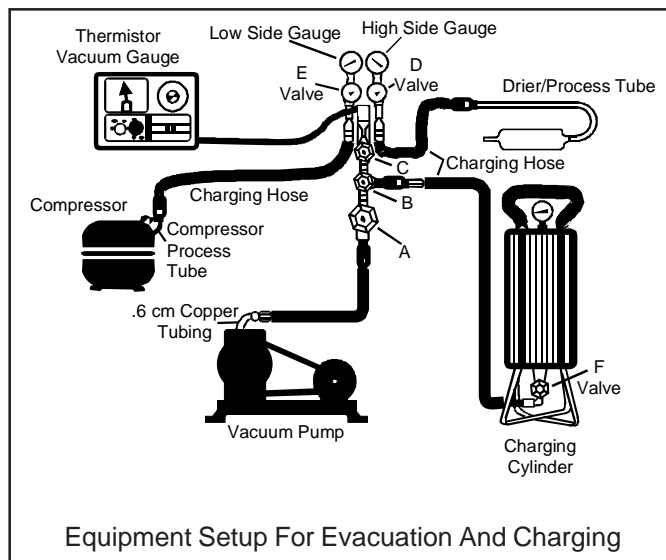

Equipment Setup For Evacuation And Charging

5. After compound gauge (low side) drops to approximately 29 inches gauge, open valve "C" to vacuum thermocouple gauge and take micron reading.

**NOTE:** A high vacuum pump can only produce a good vacuum if oil in pump is not contaminated.

6. Continue evacuating system until vacuum gauge registers 600 microns.
7. At 600 microns, close valve "A" to vacuum pump and allow micron reading in system to balance. Micron level will rise.
  - If in 2 minutes, micron level stabilizes at 1000 microns or below, system is ready to be charged.
  - If micron level rises above 1000 microns and stabilizes, open valve "A" and continue evacuating.
  - If micron reading rises rapidly and does not stabilize, a leak still exists in system.

Close valve "A" to vacuum pump and valve "C" to vacuum gauge. Invert charging cylinder and open charging cylinder valve "F" to add partial charge for leak checking. With leak detector, check manifold connections and system for leaks. After locating leak, capture refrigerant, repair leak, and begin at step 1.

# Service Procedures



## WARNING

To avoid risk of electrical shock, personal injury, or death, disconnect electrical power source to unit, unless test procedures require power to be connected. Discharge capacitor through a 10,000 ohm resistor before attempting to service. Ensure all ground wires are connected before certifying unit as repaired and/or operational.

### Charging

**NOTE:** Do not use captured or recycled refrigerant in units. Captured or recycled refrigerant voids any warranty.

**NOTE:** Charge system with exact amount of refrigerant. Refer to unit serial plate for correct refrigerant charge. Inaccurately charged system will cause future problems.

To charge system:

1. Close valves "A" to vacuum pump and "C" to vacuum gauge and "E" to low side manifold gauge.
2. Set scale on dial-a-charge cylinder for corresponding HFC134a pressure reading.
3. Open valve "F" to charging cylinder and let exact amount of refrigerant flow from cylinder into system. Close valve.  
  
Low side gauge pressure should rise shortly after opening charging cylinder valve as system pressure equalizes through capillary tube.  
  
If pressure does not equalize, a restriction typically exists at capillary/drier braze joint.
4. If pressure equalizes, open valve "E" to low side manifold gauge and pinch off high side drier process tube.
5. Start compressor and draw remaining refrigerant from charging hoses and manifold into compressor through compressor process tube.
6. To check high side pinch-off drier process tube. Close valve "D" to high side gauge. If high side pressure rises, repeat high side pinch-off and open valve "D". Repeat until high side pinch-off does not leak.
7. Pinch-off compressor process tube and remove charging hose. Braze stub closed while compressor is operating.
8. Disconnect power. Remove charging hose and braze high side drier process tube closed.
9. Recheck for refrigerant leaks.

### Refrigerant Charge

Refrigerant charge in all capillary tube systems is critical and exact amount is required for proper performance. Factory charges are shown on serial plate.

**NOTE:** Do not use refrigerant other than shown on serial plate.

# Service Procedures



## WARNING

To avoid risk of electrical shock, personal injury, or death, disconnect electrical power source to unit, unless test procedures require power to be connected. Discharge capacitor through a 10,000 ohm resistor before attempting to service. Ensure all ground wires are connected before certifying unit as repaired and/or operational.

### HFC134a Service Information

HFC134a is alternative refrigerant for CFC12. HFC134a has an ozone depletion potential (ODP) factor of 0.0 and a global warming potential (GWP) factor of 0.27. HFC134a is not flammable and has acceptable toxicity levels. HFC134a is not interchangeable with CFC12. There are significant differences between HFC134a and CFC12 which must be considered when handling and processing refrigeration system.

### Health, Safety, and Handling

Health, safety and handling considerations for HFC134A are virtually no different than those for CFC12.

Health, Safety, and Handling	CFC12	HFC134a
Allowable overall exposure limit	1,000 ppm	Same
Vapor exposure to skin	No effect	Same
Liquid exposure to skin	Can cause frostbite	Same
Vapor exposure to eye	Very slight eye irritant	Same
Liquid exposure to eye	Can cause frostbite	Same
Above minimum exposure limit	Can cause Asphyxiation, Tachycardia, and Cardia Arrhythmias	Same
Safety and handling	Wear appropriate skin and eye protection. Use with adequate ventilation.	Same
Spill management	Remove or extinguish ignition or combustion sources. Evacuate or ventilate area.	Same
Fire explosion hazards	May decompose if contact with flames and heating elements. Container may explode if heated due to resulting pressure rise. Combustion products are toxic.	Same
Disposal procedures	Recycle or reclaim.	Same



## CAUTION

To minimize contamination, exercise extreme care when servicing HFC134A sealed systems.

- No trace of other refrigerants is allowed in HFC134a systems. Chlorinated molecules in other refrigerants such as CFC12, etc. will lead to capillary tube plugging.
  - Ester oil is used in HFC134a systems. Do not use mineral oil. HFC134a and mineral oils cannot be mixed. If mineral oils were used in HFC134a systems, lubricant would not return to compressor and would cause early compressor failure. If significant amount of oil has been lost from compressor, replace oil rather than adding oil.
  - Ester oils used in HFC134a systems are so hydroscopic that by the time an inadequate system performance is detected, oil will be saturated with moisture.
  - CFC12 has much higher tolerance to system processing materials, such as drawing compounds, rust inhibitors, and cleaning compounds, than HFC134a. Such materials are not soluble in HFC134a systems. If materials were to be washed from system surfaces by ester oils, they could accumulate and eventually plug capillary tube.
  - Care must be taken to minimize moisture entering HFC134a system. Do not leave compressor or system open to atmosphere for more than 10 minutes. Excessive moisture in HFC134a system will react with compressor oil and generate acid.
  - Compressor must be replaced when performing low side leak repair.
  - Drier filter must always be replaced with service drier filter, part #B2150504.
- Important:** Unbrazing drier filter from tubing will drive moisture from desiccant and into system, causing acids to form. Do not unbrazing filter drier from tubing. If CFC12 service drier was installed in HFC134A system, drier could overload due to excessive moisture.
- HFC134a compatible copper tubing, part #R0174075 (1/4" O.D. X 18" length) and part #R0174076 (5/16" O.D. X 24" length) must be used when replacing tubing.
  - Avoid system contamination by using Towerdraw E610 evaporating oil, part # R0157532, when flaring, swaging, or cutting refrigeration tubing.



# Service Procedures



## WARNING

To avoid risk of electrical shock, personal injury, or death, disconnect electrical power source to unit, unless test procedures require power to be connected. Discharge capacitor through a 10,000 ohm resistor before attempting to service. Ensure all ground wires are connected before certifying unit as repaired and/or operational.

### Replacement Service Compressor

HFC134a service compressors will be charged with ester oil and pressurized with dry nitrogen. Before replacement compressor is installed, pull out 1 rubber plug. A *pop* from pressure release should be heard. If a *pop* sound is not heard, do not use compressor. Positive pressure in compressor is vital to keep moisture out of ester oil. Do not leave compressor open to atmosphere for more than 10 minutes.

### Compressor Testing Procedures



## WARNING

To avoid death or severe personal injury, never use oxygen, air or acetylene for pressure testing or clean out of refrigeration system. Use of oxygen, air, or acetylene may result in violent explosion. Oxygen may explode on contact with oil and acetylene will spontaneously explode when under pressure.

Refer to Technical Data Sheet "Temperature Relationship Chart" for operating watts, test points, and temperature relationship test for unit being tested.

- Temperature testing is accomplished by using 3 lead thermocouple temperature tester in specific locations. Test point T-1 is outlet on evaporator coil and T-2 is inlet. Test point T-3 is suction tube temperature midway between where armaflex ends and suction port of compressor (approximately 12 inches from compressor).
- Thermocouple tips should be attached securely to specified locations.
- Do not test during initial *pull down*. Allow one off cycle or balanced temperature condition to occur before proceeding with testing.
- Refrigerator must operate minimum of 20 minutes after thermocouples are installed.
- Turn control to colder to obtain required on time.
- Wattage reading must be recorded in conjunction with temperature test to confirm proper operation.
- Suction and head pressures are listed on "Temperature and Relationship Chart". Normally these are not required for diagnosis but used for confirmation on systems which have been opened.

### Brazing



## CAUTION

To avoid risk of personal injury or property damage, take necessary precautions against high temperatures required for brazing.

Satisfactory results require cleanliness, experience, and use of proper materials and equipment.

Connections to be brazed must be properly sized, free of rough edges, and clean.

Generally accepted brazing materials are:

- **Copper to copper joints:** SIL-FOS (alloy of 15 percent silver, 80 percent copper, and 5 percent phosphorous). Use without flux. Recommended brazing temperature is approximately 1400°F. **Do not use for copper to steel connection.**
- **Copper to steel joints:** SILVER SOLDER (alloy of 30 percent silver, 38 percent copper, 32 percent zinc). Use with fluoride based flux. Recommended brazing temperature is approximately 1200°F.
- **Steel to steel joints:** SILVER SOLDER (see copper to steel joints).
- **Brass to copper joints:** SILVER SOLDER (see copper to steel joints).
- **Brass to steel joints:** SILVER SOLDER (see copper to steel joints).

# Refrigerant Flow

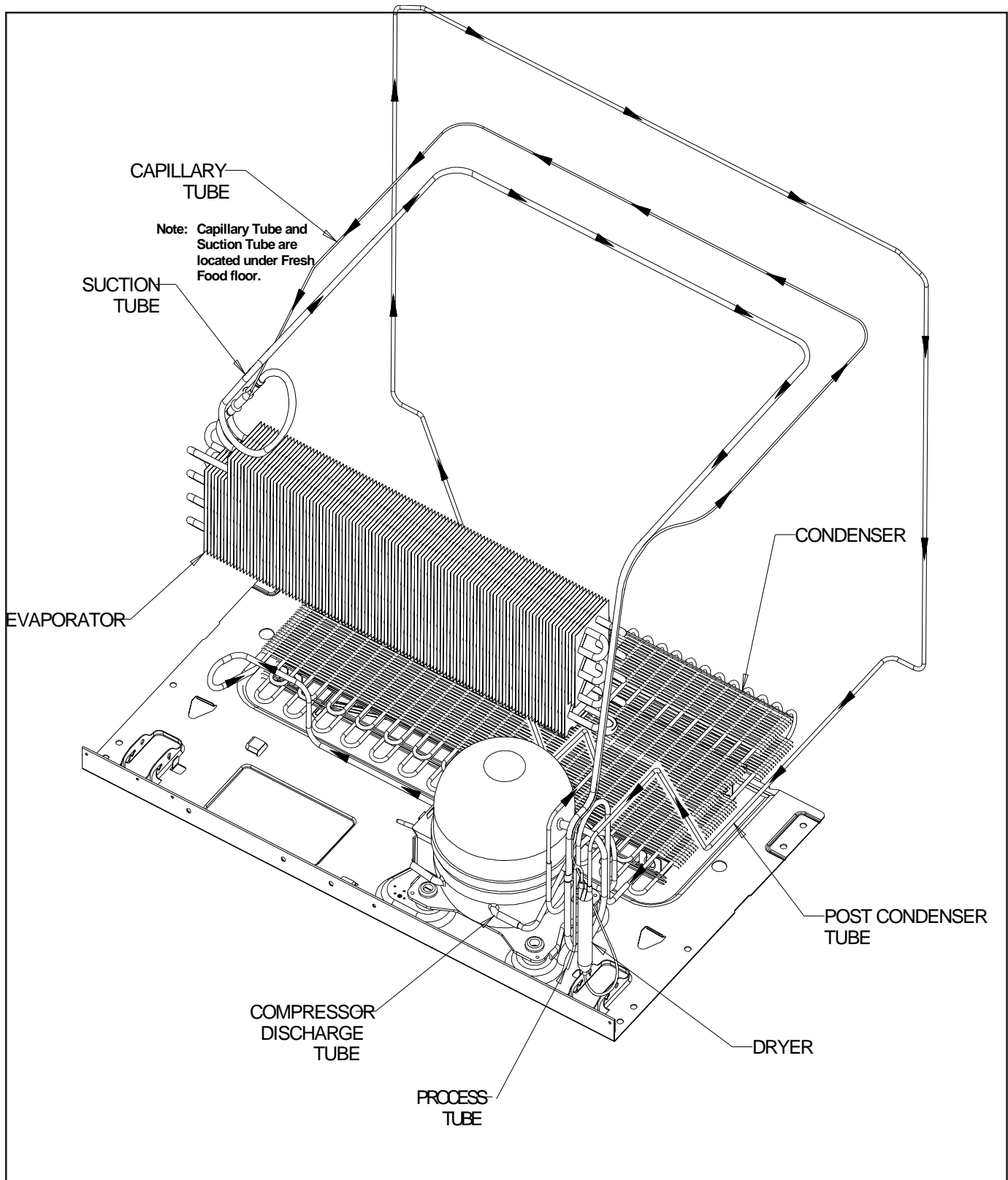

20, 22, 25 cu. ft. Bottom Mount Refrigerant Flow Diagram

# Cabinet Air Flow

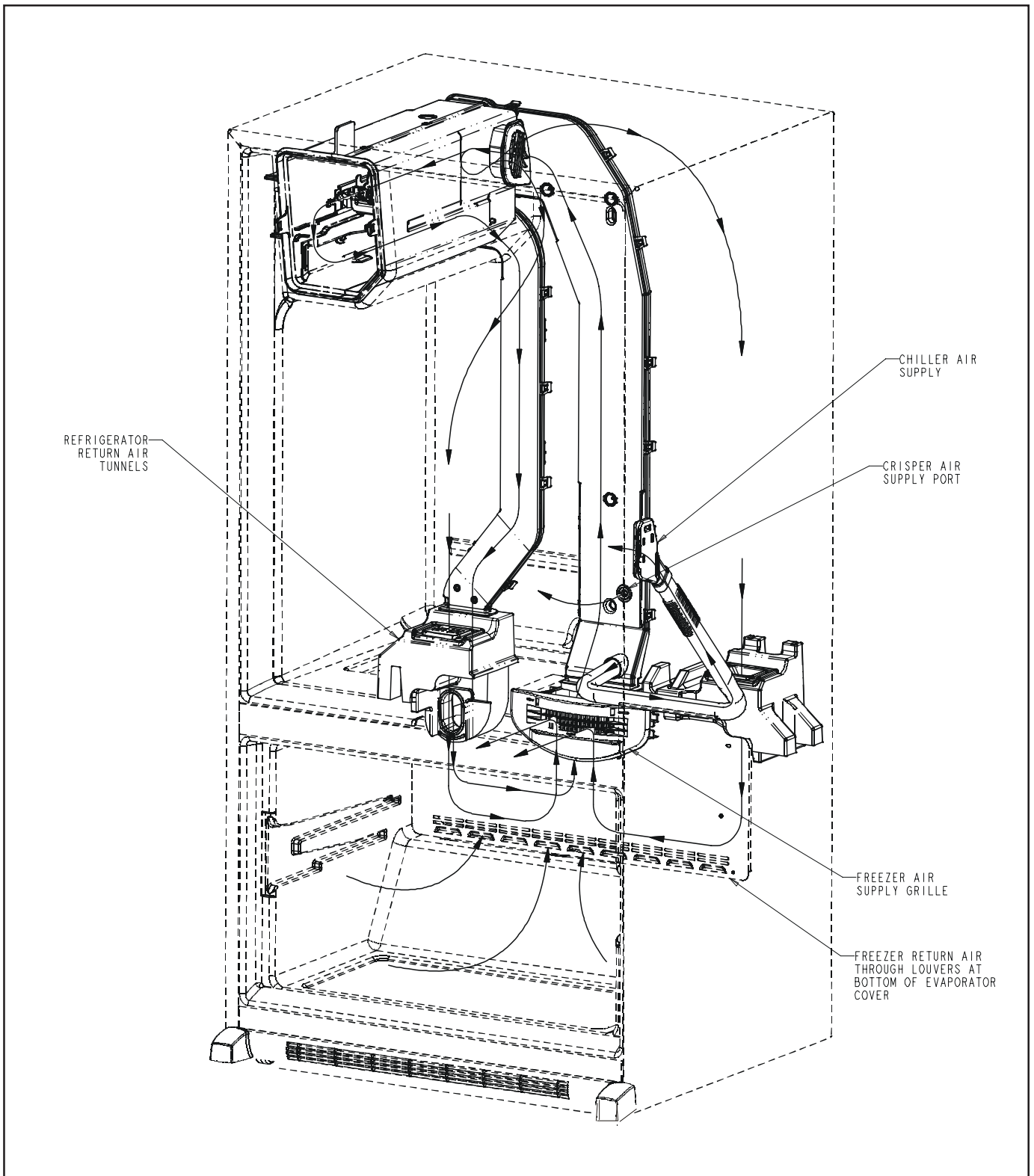

**20, 22, 25 cu. ft. Bottom Mount  
Cabinet Air Flow Diagram**

# Machine Compartment Air Flow

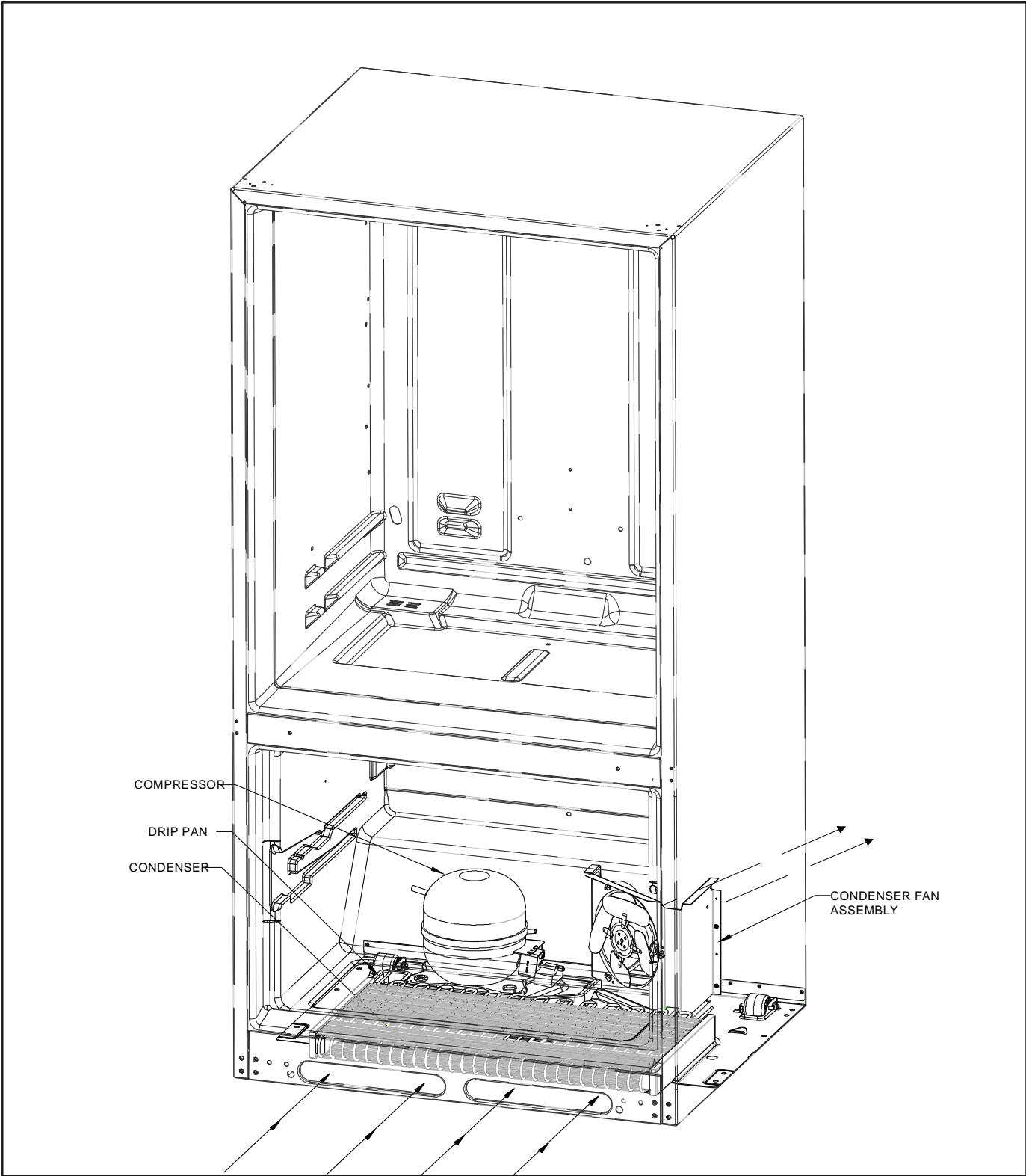

**20, 22, 25 cu. ft. Model Bottom Mount  
Machine Compartment Air Flow Diagram**

# Water Dispenser

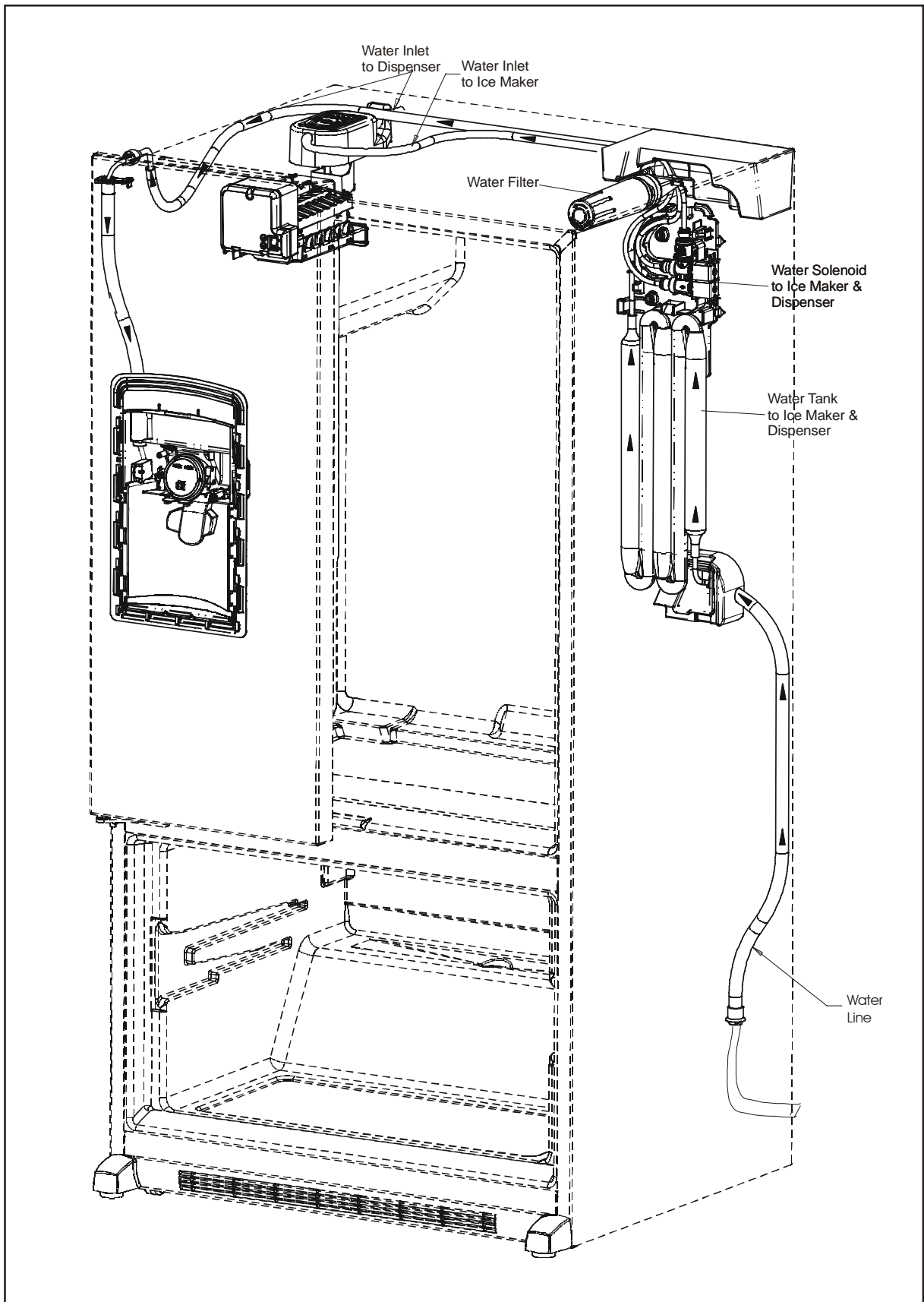

20, 22, 25 cu. ft. Model Bottom Mount  
Water Flow Diagram

# Water Flow Schematic

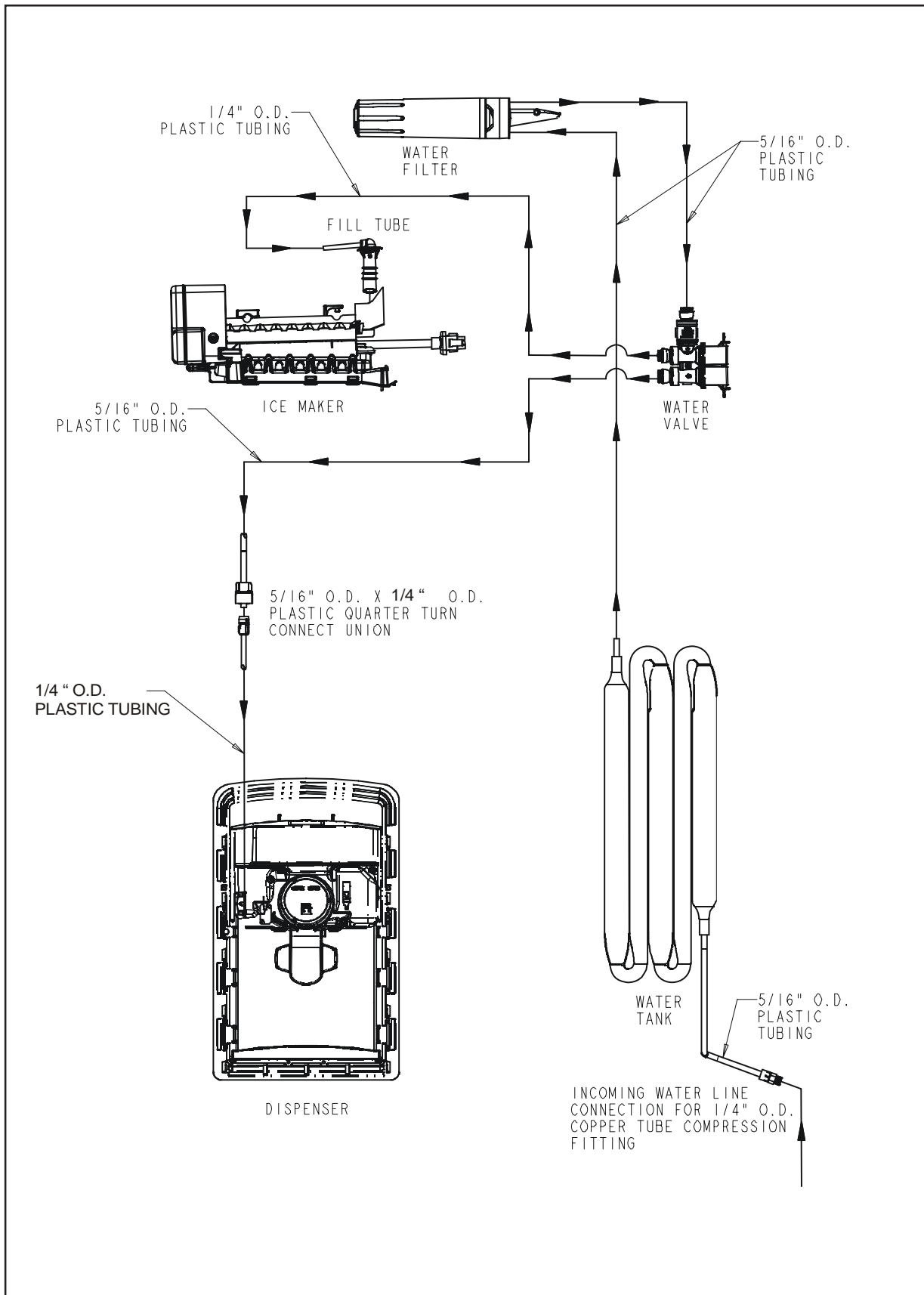

**20, 22, 25 cu. ft. Model Bottom Mount  
Water Flow Schematic**

# Typical External Sweat Pattern

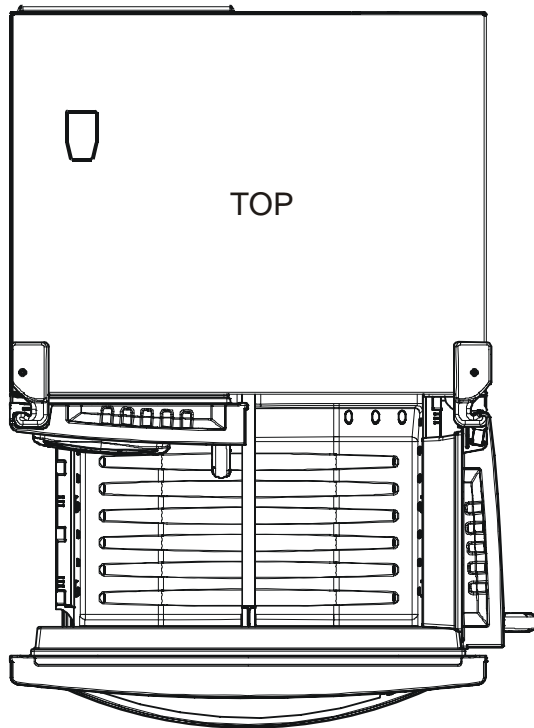
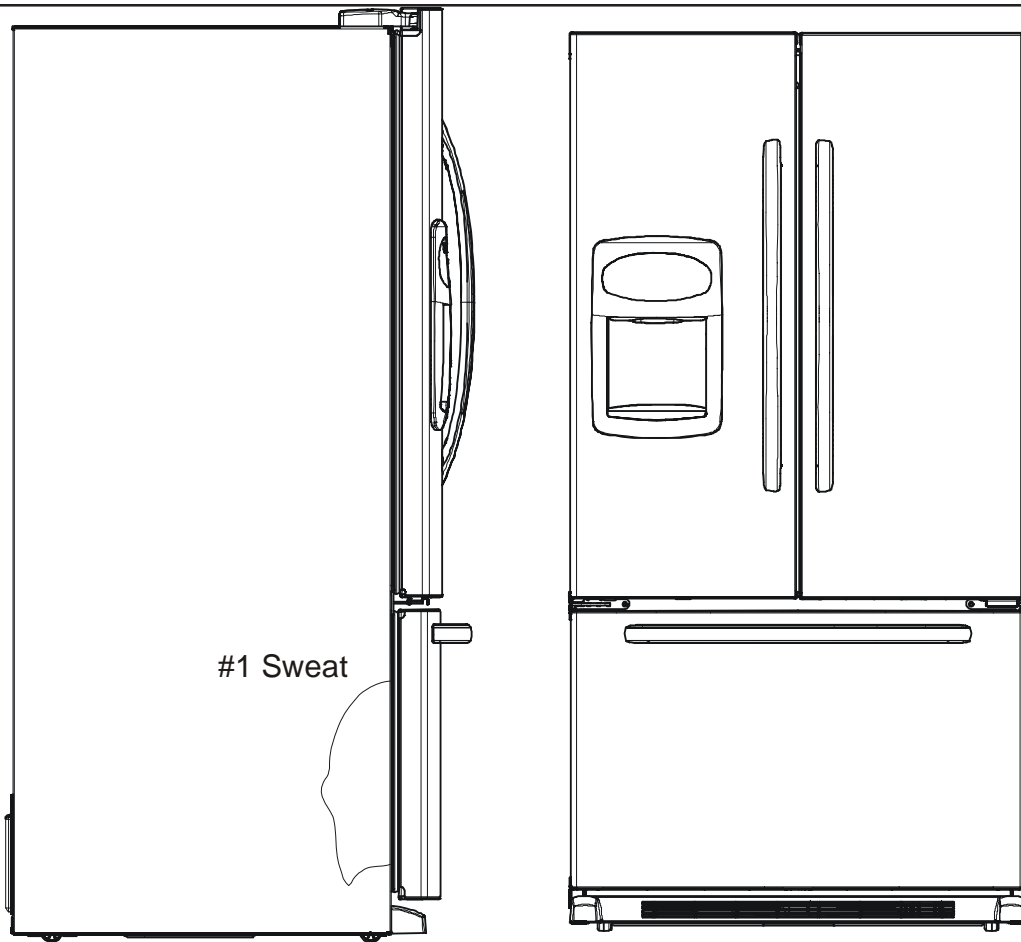

## Classification of Condensation

- 1 = Haze or Fog
- 2 = Beading
- 3 = Beads or small drops
- 4 = Drops running together

## Conditions after 4 hour Laboratory Sweat Test:

- Ambient 90 dF
- Relative humidity 84%
- Refrigerator Temp. 40 dF
- Freezer Temp. 0 dF

# Troubleshooting Chart



## WARNING

To avoid risk of electrical shock, personal injury, or death, disconnect electrical power source to unit, unless test procedures require power to be connected. Discharge capacitor through a resistor before attempting to service. Ensure all ground wires are connected before certifying unit as repaired and/or operational.

Troubleshooting chart on following pages contains symptoms that may be seen in malfunctioning units. Each symptom is accompanied by one or more possible causes and by a possible remedy or test to determine if components are working properly.

Symptom	Possible Causes	Corrective Action
Unit does not run	No power to unit	Check for power at outlet. Check fuse box/circuit breaker for blown fuse or tripped breaker. Replace or reset.
	Faulty power cord	Check with test light at unit; if no circuit and current is indicated at outlet, replace or repair.
	Low voltage	Check input voltage for proper voltage. Take appropriate action to correct voltage supply problem.
	Faulty motor or freezer temperature control	Check all connections are tight and secure. Use Control Board Service Mode to check motor.
	Faulty relay	Check relay. Replace if necessary.
	Faulty compressor	Check compressor motor windings for opens/shorts. Perform compressor direct wiring test. Replace if necessary.
	Faulty overload	Check overload for continuity. <b>NOTE:</b> Ensure compressor/overload are below trip temperature before testing. Replace if necessary.
Refrigerator section too warm	Excessive door opening	Consumer education
	Overloading of shelves	Consumer education
	Warm or hot foods placed in cabinet	Consumer education
	Cold control set too warm	Set control to colder setting.
	Poor door seal	Level cabinet. Adjust hinges. Replace gasket.
	Refrigerator airflow	Check damper is opening by removing grille. With door open, damper should open. Replace if faulty. Check Ice Box fan for operation. Turn control setting to colder position.
	Faulty condenser fan or evaporator fan	Use Control Board Service Mode to check motor. Check fan and wiring. Replace if necessary.
Faulty compressor	Use Control Board Service Mode to check motor. Replace compressor.	



# Troubleshooting Chart



## WARNING

To avoid risk of electrical shock, personal injury, or death, disconnect electrical power source to unit, unless test procedures require power to be connected. Discharge capacitor through a resistor before attempting to service. Ensure all ground wires are connected before certifying unit as repaired and/or operational.

Symptom	Possible Causes	Corrective Action
Refrigerator section too cold	Refrigerator temperature control set too cold or faulty Fresh Food thermistor	Adjust refrigerator temperature control or check thermistor.
	Refrigerator airflow not properly adjusted	Check air flow.
Freezer and refrigerator sections too warm	Temperature controls set too warm	Reset temperature controls.
	Poor door seal	Level cabinet. Adjust hinges. Replace gasket.
	Dirty condenser or obstructed grille	Check condenser and grille. Clean.
	Faulty control	Test main control. Replace if failed.
	Refrigerant shortage or restriction	Check for leak or restriction. Repair, evacuate and recharge system.
Freezer section too cold	Freezer temp control set too cold	Adjust freezer temperature control.
	Faulty control	Test main control. Replace if failed.
Unit runs continuously	Temperature control set too cold	Adjust temperature control.
	Dirty condenser or obstructed grille	Check condenser and grille. Clean.
	Poor door seal	Level cabinet. Adjust hinges. Replace gasket.
	Faulty condenser fan or evaporator fan	Check fan and wiring. Replace if necessary.
	Faulty control	Test main control. Replace if failed.
	Refrigerant shortage or restriction	Check for leak or restriction. Repair, evacuate and recharge system.
	Refrigerant overcharge	Check for overcharge. Evacuate and recharge system.
	Air in system	Check for low side leak. Repair, evacuate and recharge system.
Unit runs continuously. Temperature normal.	Ice on evaporator	See "Ice on evaporator".
Unit runs continuously. Temperature too cold.	Faulty defrost thermostat	Check thermostat. Replace if necessary.
Noisy operation	Loose flooring or floor not firm	Repair floor or brace floor.
	Cabinet not level	Level cabinet.
	Tubing in contact with cabinet, other tubing, or other metal	Adjust tubing.
	Drip pan vibrating	Adjust drain pan.
	Fan hitting another part	Ensure fan is properly aligned and all attaching hardware and brackets are tight and not worn. Tighten or replace.
	Worn fan motor bearings	Check motor for loss of lubricant or worn bearings. Replace if necessary.
	Compressor mounting grommets worn or missing. Mounting hardware loose or missing	Tighten hardware. Replace grommets if necessary.
	Free or loose parts causing or allowing noise during operation	Inspect unit for parts that may have worked free or loose or missing screws. Repair as required.

# Troubleshooting Chart



## WARNING

To avoid risk of electrical shock, personal injury, or death, disconnect electrical power source to unit, unless test procedures require power to be connected. Discharge capacitor through a resistor before attempting to service. Ensure all ground wires are connected before certifying unit as repaired and/or operational.

Symptom	Possible Causes	Corrective Action
Frost or ice on evaporator	Defrost thermostat faulty	Check defrost thermostat. Replace if failed.
	Evaporator fan faulty	Check fan motor. Replace if failed.
	Defrost heater remains open	Check defrost heater continuity. Replace if failed.
	Defrost control faulty	Check main control and replace if failed.
	Open wire or connector	Check wiring and connections. Repair as necessary.
	Refrigerant shortage or restriction	Check for leak or restriction. Repair, evacuate and recharge system.
Unit starts and stops frequently (cycles on and off)	Loose wire connections	Check wiring and connections. Repair as necessary.
	Supply voltage out of specification	Check input voltage. Correct any supply problems.
	Overload protector open	Check overload protector for continuity. If open, replace overload. <b>NOTE:</b> Ensure overload/compressor are below trip temperature before testing.
	Faulty compressor motor capacitor (some compressors do not require motor capacitor)	Check capacitor for open/short. Replace if necessary. <b>NOTE:</b> Discharge capacitor before testing.
	Faulty fan motor	Check fan motor. Replace if failed.
	Restricted air flow	Check condenser and grille for dirt. Clean.
	Refrigerant shortage or restriction	Check for leak or restriction. Repair, evacuate and recharge system.
No Interior lights, and appliance is still running.	In Sabbath mode.	If Dispenser lights are also off, see Sabbath mode.
	Door has been left open for 10 continuous minutes.	Close all three doors for at least one second to reset control.
	Open circuit on neutral side of light circuit.	Open circuit (wiring or main control board) from neutral to light sockets.

# System Diagnosis

CONDITION	SUCTION PRESSURE VARIATION FROM NORMAL	HEAD PRESSURE VARIATION FROM NORMAL	T1 INLET TEMPERATURE VARIATION FROM NORMAL	T2 OUTLET TEMPERATURE VARIATION FROM NORMAL	T3 SUCTION TEMPERATURE VARIATION FROM NORMAL	WATTAGE VARIATION FROM NORMAL
Refrigerant Overcharge	Increase	Increase	Warmer	Warmer	Colder	Increase
Shortage of Refrigerant	Decrease	Decrease or Increase See Text	Colder	Warmer	Warmer	Decrease
Partial Restriction	Decrease	Decrease or Increase See Text Note 2	Colder	Warmer	Warmer	Decrease
Air in System	Near Normal	Increase	Warmer	Warmer	Warmer	Increase
Low Ambient Installations (High Ambients the Reverse)	Decrease	Decrease	Colder	Warmer	Warmer	Decrease
Additional Heat Load	Increase	Increase	Warmer	Warmer	Warmer	Increase
Inefficient Compressor	Increase	Normal or Decrease	Warmer or Colder	Warmer	Warmer	Decrease

## Symptoms of an Overcharge

- Above normal freezer temperatures.
- Longer than normal or continuous run.
- Freezing in refrigerator.
- Higher than normal suction and head pressure.
- Higher than normal wattage.
- Evaporator inlet and outlet temperatures warmer than normal.
- Suction tube temperature below ambient. Always check for separated heat exchanger when suction temperature is colder than ambient.

Various conditons could indicate an overcharge. For example, if the cooling coil is not defrosted at regular intervals, due to a failure of the defrost system, the refrigerant will "flood out" and cause the suction line to frost or sweat. The cause of this problem should be corrected rather than to purge refrigerant from the sytem. Running the freezer section colder than necessary (-2 to -1 F. is considered normal package temperatures) or continuous running of the compressor for a variety of reasons, or the freezer fan motor not running, may give the indication of an overcharge.

## Symptoms of Refrigeration Shortage

- Rise in food product temperature in both compartments. (See Note 1 below.)
- Long or continuous run time.
- Look for obvious traces of oil that would occur due to a leak or cracked refrigerant line.
- Lower than normal wattage.
- Compressor will be hot to touch because of the heat generated by the motor windings from long continuous running. It will not be as hot as it would be with a full charge and long run times for some other reason such as a dirty condenser.
- Depending on the amount of the shortage, the condenser will not be hot, but closer to room temperature. The capillary tube will be warmer than normal from a slight shortage.
- If the leak is on the high side of the system, both gauges will show lower than normal readings and will show progressively lower readings as this charge becomes less. The suction pressure guage will probably indicate a vacuum.
- If the leak is on the low side of the system the suction pressure guage will be lower than normal - probably in a vacuum - and the head pressure gauge will be higher than normal. It will probably continue to become higher because air drawn in through the leak is compressed by the compressor and accumulates in

# System Diagnosis

the high side (condenser) of the system.

- Only partial frosting of evaporator instead of even frosting of entire coil.

**NOTE 1:** Usually the first thing that is noticed by the user is a rise in temperature foods. Although temperatures will rise in both the freezer section and the food compartment, the frozen meats and vegetables will not thaw immediately. The customer doesn't associate the problem with the freezer section and will first notice that milk and other food beverages are not cold enough.

Under some circumstances, such as in the case of forced air meatkeeper model with a slight shortage of refrigerant, freezing in the food compartment may be experienced due to the additional running time. With a refrigerant leak, however, it always gets worse and as the refrigerant charge decreases the temperature will continue to rise.

With a shortage of refrigerant the capillary line will not have a full column of liquid. As a result, there is a noticeable hissing sound in the evaporator. This should not be mistaken for the regular refrigerant boiling sounds that would be considered normal.

## Symptoms of a Restriction

Always remember refrigeration (cooling) occurs on the low pressure side of a partial restriction (obviously a total restriction will completely stop the circulation of refrigerant and no cooling will take place).

Physically feel the refrigeration lines when a restriction is suspected. The most common place for a restriction is at the drier-filter or at the capillary tube inlet or outlet. If the restriction is not total there will be a temperature difference at the point of restriction, the area on the evaporator side will be cooler. In many cases frost and/or condensation will be present. A longer time is required for the system to equalize.

Any kinked line will cause a restriction so the entire system should be visually checked.

A slight restriction will give the same indications as a refrigerant shortage with lower than normal back pressure, head pressure, wattage and warmer product temperatures.

**NOTE 2:** If a total restriction is on the discharge side of the compressor, higher than normal head pressures and wattages would result. This is true only while the low side is being pumped out and if the restriction was between the compressor and the first half of the condenser.

To diagnose for a restriction versus a refrigerant shortage, discharge the system, replace the drier-filter, evacuate and recharge with the specified refrigerant charge. If the unit performs normally three possibilities exist: 1) refrigerant loss, 2) partially restricted drier-filter, and 3) moisture in system.

If the unit performs as it previously did you may have a restricted capillary line or condenser or kinked line. Find the point of restriction and correct it.

A restriction reduces the flow rate of the refrigerant and consequently reduces the rate of heat removal. Complete restriction may be caused by moisture, solid contaminants in the system, or a poorly soldered joint. Moisture freezes at the evaporator inlet end of the capillary tube or solid contaminants collect in the drier-filter. The wattage drops because the compressor is not circulating the usual amount of refrigerant.

As far as pressure readings are concerned, if the restriction, such as a kinked line or a joint soldered shut is anywhere on the low side, the suction pressure would probably be in a vacuum while the head pressure will be near normal. If the restriction is on the high side, the suction pressure, again, will probably be in a vacuum while the head pressure will be higher than normal during the pump out period described earlier. In either case, it will take longer than the normal ten minutes or so for the head pressure to equalize with the low side after the compressor stops.

## Symptoms of Air in System

This can result from a low side leak or improper servicing. If a leak should occur on the low side, the temperature control would not be satisfied; thus, continuous running of the compressor would result. The compressor would eventually pump the low side into a vacuum drawing air and moisture into the system. Air and R134A do not mix so the air pressure would be added to the normal head pressure, resulting in higher than normal head pressures.

One way to determine if air is in the system is to read the head pressure gauge with the product off and evaporator and condenser at the same temperature and then take the temperature on the condenser outlet tube. This temperature should be within 3° or 4° F. of what the Pressure-Temperature Relation chart shows for the given idle head pressure. If the temperature of the condenser outlet is considerably lower than the idle head pressure of the gauge this would indicate there is air in the system.

Thorough leak checking is necessary. Correct the source of the leak. Do not attempt to purge off the air because this could result in the system being undercharged. It is best to discharge, replace drier, evacuate and recharge with the specified refrigerant charge.

# **System Diagnosis**

## **Symptoms of Low or High Ambient Temperature Installation**

Lower ambient air temperature reduces the condensing temperature and therefore reduces the temperature of the liquid entering the evaporator. The increase in refrigeration effect due to operation in a lower ambient results in a decrease in power consumption and run time. At lower ambients there is a reduction in cabinet heat leak which is partially responsible for lower power consumption and run time.

An increase in refrigeration effect cannot be expected below a certain minimum ambient temperature. This temperature varies with the type and design of the product.

Generally speaking, ambient temperatures cannot be lower than 60° F. without affecting operating efficiency. Conversely, the higher the ambient temperature the higher the head pressure must be to raise the high side refrigerant temperature above that of the condensing medium. Therefore, head pressure will be higher as the ambient temperature raises. Refrigerators installed in ambient temperatures lower than 60° F. will not perform as well because the pressures within the system are generally reduced and unbalanced. This means that the lower head pressure forces less liquid refrigerant through the capillary line. The result is the symptoms of a refrigerant shortage. The lower the ambient temperature the more pronounced this condition becomes.

When a point where the ambient temperature is below the cut-in of the Temperature Control is reached, the compressor won't run.

The drain traps will freeze in ambient temperatures of 32° F.

### **Heat Load**

A greater heat load can result from the addition of more than normal supply of foods, such as after doing the weekly shopping. Other items contributing to an additional heat load would be excessive door openings, poor door sealing, interior light remaining on, etc.

An increase in heat being absorbed by the refrigerant in the evaporator will affect the temperature and pressure of the gas returning to the compressor. Compartment temperatures, power consumption, discharge, and suction pressures are all affected by heat load.

Pressures will be higher than normal under heavy heat load.

# Disassembly Procedures

## WARNING

To avoid risk of electrical shock, personal injury, or death, disconnect electrical power source to unit, unless test procedures require power to be connected. Discharge capacitor through a resistor before attempting to service. Ensure all ground wires are connected before certifying unit as repaired and/or operational.

### Door Removal

#### Fresh Food Door

1. Open both compartment doors. Remove door buckets, all shelving and drawers from refrigerator and freezer compartments. Place components on a padded surface to avoid damage.
2. Close both doors and tape them shut so they won't fall off unexpectedly when hinges are removed.

**NOTE:** To minimize possibility of personal injury and/or property damage, make sure unit doors are taped shut before you undertake the next steps:

3. On top of unit, remove screw and retain plastic cap from door hinge.
4. Remove and retain screws from top door hinge.
5. Pull tape off of door and lift door off unit. Set door on a padded surface to prevent damage to finish.
6. Remove and retain center hinge pin and all plastic shims. Note number and location of shims as you do so.

#### Freezer Drawer

1. Open drawer to fully open position.
2. Remove upper and lower baskets.
3. Remove screws one in each rail marked on side of rail.
4. Lift front of drawer up and out to remove drawer.
5. Set drawer on a padded surface to prevent damage to finish.

### Refrigerator Compartment

#### Upper Light Bulb Cover

1. Squeeze tabs on each side of light cover and pull cover down to release it from holding tabs. Retain all parts.

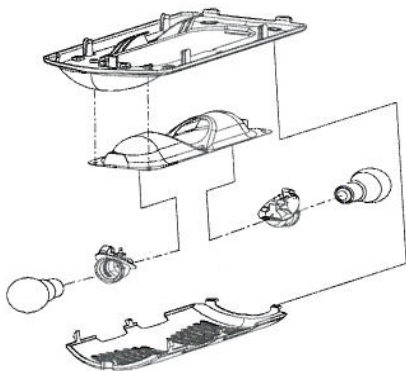

Upper Light Assembly

#### Light Bulb Assembly

1. Squeeze tabs on each side of light cover and pull cover down to release it from holding tabs. Retain all parts.
2. Remove light bulbs.
3. Use flat blade screwdriver to release 4 tabs by inserting into long slots and prying out.
4. Use a taped putty knife to carefully pry front edge of light assembly plastic housing. This releases tabs holding up front of housing.
5. When released disconnect connector plugged in to cabinet liner.

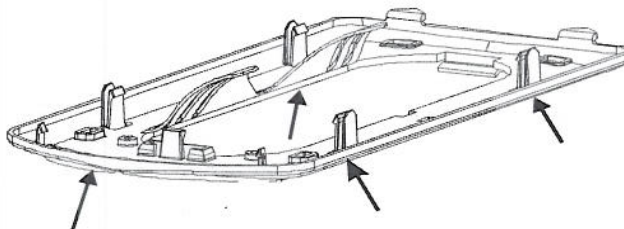

#### Light Bulb Sockets

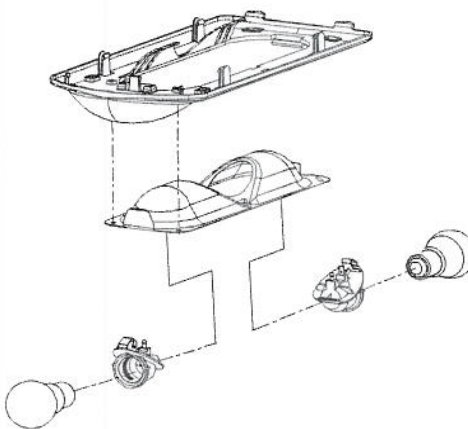

#### Light Switches

1. Carefully pry with taped putty knife along the edge of light switch.
2. Disconnect wires from light switch.
3. Reverse procedure to reassemble.

# Disassembly Procedures



## WARNING

To avoid risk of electrical shock, personal injury, or death, disconnect electrical power source to unit, unless test procedures require power to be connected. Discharge capacitor through a resistor before attempting to service. Ensure all ground wires are connected before certifying unit as repaired and/or operational.

### Fresh Food Thermistor

1. Follow instructions in removing Upper Light assembly.
2. Upper light housing will drop down exposing Thermistor.
3. Cut wires to Thermistor at Thermistor.
4. Remove Thermistor from clip.

### Water Tank

1. Turn water off to unit.
2. Disconnect water line that supplies water tank from water supply.
3. Remove crispers and shelves from right side of fresh food compartment.
4. Remove covers on back bulkhead by inserting screwdriver in slots to release tabs.
5. Disconnect water line from outlet of tank to inlet of water valve by holding tubing collar stationary and pulling water tube out of valve.
6. Remove water tank and tubing.
7. Reverse procedure to reassemble.

### Water Dispenser Facade

1. Turn water off to unit.
2. Remove drip tray by pulling out on tray.
3. Remove hex head screws to release water dispenser facade.
4. Lift facade up and off of door. Disconnect wiring to low voltage board.
5. Reverse procedure to reassemble.

### Low Voltage Board

1. Follow instructions in removing Water Dispenser Facade.
2. Unplug ribbon connector from keyboard to low voltage board.
3. Unclip low voltage board from facade.
4. Reverse procedure to reassemble.

Note: Take care in handling ESD sensitive parts.  
(Discharge self and handle board on edges)

### Chute Extension / Yoke Assembly

1. Follow instructions in removing Water Dispenser Facade.
2. Remove water line from Chute Extension / Yoke Assembly.
3. Remove hex head screws holding assembly to door cavity and remove assembly.
4. Reverse procedure to reassemble.

### Ice Box Compartment

#### Ice Bin Assembly

1. Remove Ice Bin by depressing push button on side of Ice Bin cover and slide bin out of Ice Box Compartment.
2. Reverse procedure to reassemble.

#### Icemaker Assembly

1. Follow instructions in removing Ice Bin assembly.
2. Remove Icemaker wire harness cover by inserting screwdriver in slot. Push up on screwdriver to push locking lever behind cover down and then pull cover to release.
3. Disconnect Icemaker wire harness.
4. To prevent damage to wiring exiting the cabinet back and against outer ice box wall, release locking lever and slide icemaker / auger assembly out of ice box.
5. Remove screw holding Icemaker to Impinger.
6. Remove Icemaker from Impinger.

#### Ice Box Fan

1. Follow instructions in removing Ice Bin assembly.
2. Follow instructions in removing Icemaker assembly steps 1-4.
3. Press tabs in on both sides of Ice box fan shroud to release shroud.
4. Disconnect fan motor harness.
5. Pull fan off of motor shaft.
6. Using a screwdriver release tabs holding motor bracket to shroud.
7. Remove motor from shroud.
8. Reverse procedure to reassemble.

#### Auger Motor

1. Follow instructions in removing Ice Bin assembly.
2. Follow instructions in removing Icemaker assembly steps 1-4.
3. Remove Icemaker auger yoke by turning it clockwise to unscrew it from auger motor shaft.
4. Remove three screws holding auger motor to icemaker assembly.
5. Disconnect wires from auger motor.

# Disassembly Procedures



## WARNING

To avoid risk of electrical shock, personal injury, or death, disconnect electrical power source to unit, unless test procedures require power to be connected. Discharge capacitor through a resistor before attempting to service. Ensure all ground wires are connected before certifying unit as repaired and/or operational.

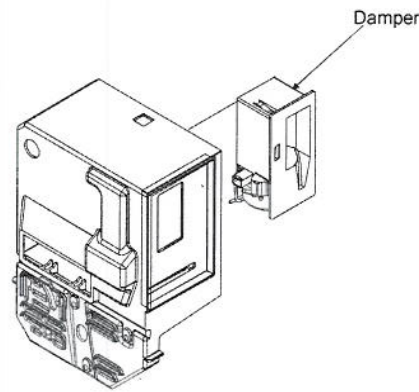
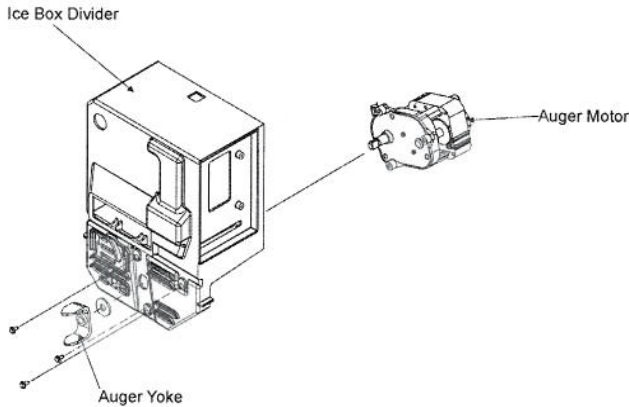

### Solenoid

1. Follow instructions in removing Ice Bin assembly.
2. Follow instructions in removing Icemaker assembly steps 1-4
3. Press tabs in on both sides of ice box fan shroud to release shroud. Remove fan shroud.
4. Slide wire harness grommet out of slot.
5. Depress two tabs holding solenoid bracket to Icemaker assembly.
6. Slide solenoid bracket out of icemaker assembly.
7. Disconnect wire harness from solenoid.

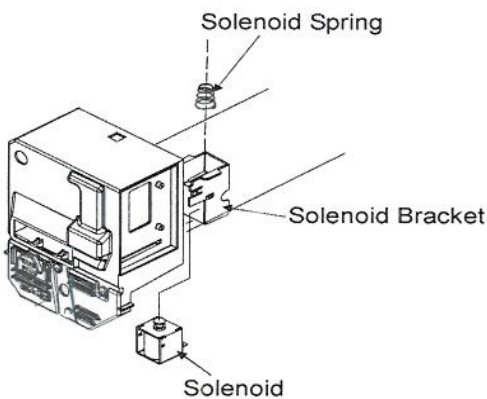

### Damper

1. Follow instructions in removing Ice Bin assembly.
2. Follow instructions in removing Icemaker assembly steps 1-4
3. Press tabs in on both sides of ice box fan shroud to release shroud. Remove fan shroud.
4. Slide damper out of Icemaker assembly.
5. Disconnect wire harness from damper.

### Ice Box Thermistor

1. Follow instructions in removing Ice Bin assembly.
2. Follow instructions in removing Icemaker assembly steps 1-4
3. Cut wires to ice box thermistor.
4. Remove ice box thermistor from thermistor clip.

### Freezer Compartment

#### Freezer Thermistor

1. Remove thermistor cover located on the evaporator cover by inserting a screw driver in slot and releasing tab holding thermistor cover on.
2. Unclip thermistor from cover and cut wires to thermistor.
3. Remove thermistor.

#### Light Socket

1. Squeeze lens to release lens cover and remove.
2. Remove light bulb.
3. Carefully pry with taped putty knife the front of light bulb assembly to release tabs.
4. Squeeze tab holding light housing in place to release housing and remove.
5. Disconnect wires to socket.
6. Squeeze tab on back side of housing to release socket.

#### Light Switch

1. Carefully pry with taped putty knife pry the front of light bulb assembly to release tabs.
2. The whole light bulb assembly will drop down.
3. Disconnect wiring to light switch.
4. Squeeze tabs on back side of switch to release it from assembly.



# Disassembly Procedures



## WARNING

To avoid risk of electrical shock, personal injury, or death, disconnect electrical power source to unit, unless test procedures require power to be connected. Discharge capacitor through a resistor before attempting to service. Ensure all ground wires are connected before certifying unit as repaired and/or operational.

### Freezer Back Panel

**NOTE:** Freezer compartment should now be empty and walls should be clear of anything that will obstruct removal of back panel.

1. Press tabs that hold both freezer door glides in place at left and right sides of compartment.
2. Remove freezer drawer glides.
3. Remove left or right door glide adapter to allow clearance to remove freezer back panel.
4. Remove freezer air grill by prying in towards center with screwdriver the two slots provided to release tabs.
5. Remove hex head screws that hold back panel and remove panel.

### Evaporator Fan and Evaporator Motor

1. Follow instructions in removing freezer back panel.
2. Remove screws that anchor evaporator fan bracket to back wall of compartment. Pull fan and bracket out of place as a unit.
3. Free fan bracket from wiring harness by disconnecting wires to motor and wire in clips that go to defrost terminator.
4. Pull evaporator fan blade off motor shaft.
5. Separate bracket and motor by squeezing lower retainer bracket to release motor from bracket.
6. When reinstalling motor reference position of terminals of new motor the same as old motor.

### Defrost Thermostat

1. Thermostat is fastened to evaporator tubing with a spring clip.
2. Snap thermostat off tubing and cut wires to thermostat.
3. Remove thermostat from unit.

### Defrost Heater

1. Follow instructions in removing freezer back panel.
2. Remove hex head screws retaining evaporator to back cabinet wall.
3. Disconnect plugs from both sides of heater.
4. Release connectors from air dams on each side of evaporator coil.
5. Grip evaporator tubing at left and right sides and tug

evaporator sharply forward. Evaporator will pop out of plastic clips that hold it to back wall of unit. Then roll bottom of evaporator forward and up, exposing evaporator heater in its location amid fins at bottom of evaporator.

6. Taking care to notice how and where they are placed, remove spring clips that hold heater into evaporator fins.
7. Pull evaporator heater out of evaporator fins, being careful that heater electrical leads do not snag on air dams, evaporator fins, tubing or other objects.

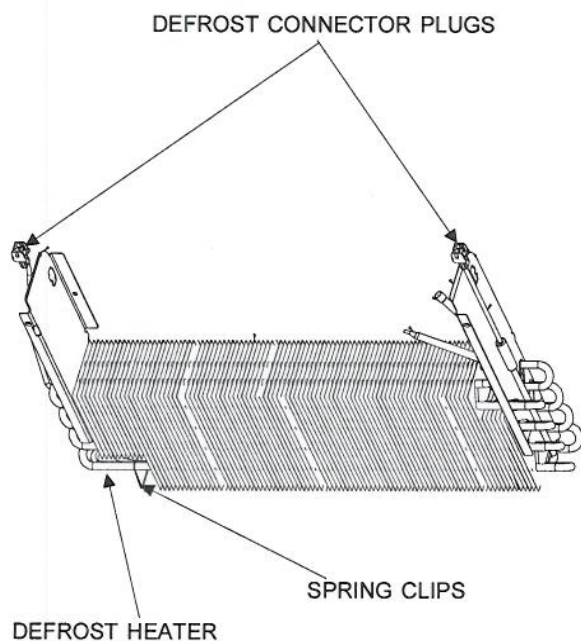

### Evaporator Removal

**NOTE:** Reclaim refrigerant per instructions in "Service Procedures" before attempting evaporator removal. To avoid system contamination, do not leave system open for more than 10 minutes.

1. Follow instructions in removing freezer back panel.
2. Remove defrost thermostat. Refer to defrost thermostat removal.
3. Remove defrost heater. Refer to defrost heater removal.
4. Install protective cloth to prevent damage to cabinet liner.
5. Unbraid suction copper fitting at evaporator.
6. Score and break copper capillary at evaporator.
7. Install new evaporator and reassemble, taking care in

# Disassembly Procedures



## WARNING

To avoid risk of electrical shock, personal injury, or death, disconnect electrical power source to unit, unless test procedures require power to be connected. Discharge capacitor through a resistor before attempting to service. Ensure all ground wires are connected before certifying unit as repaired and/or operational.

not kinking tubing when reassembling.

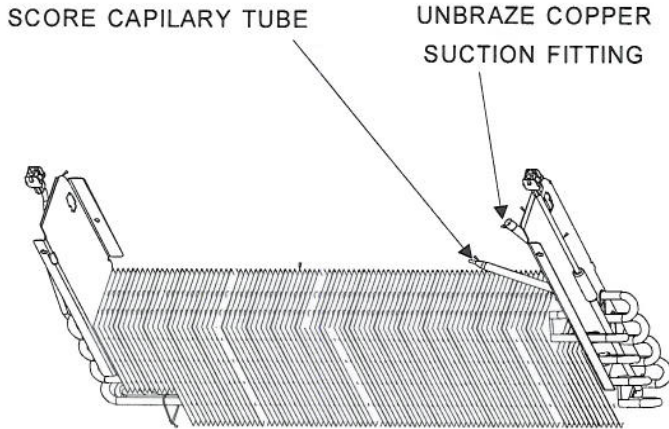

### Drawer Assembly

1. Open drawer to fully open position.
2. Remove upper baskets.
3. Remove screws one in each rail marked on side of rail.
4. Lift front of drawer up and out to remove drawer.

### Drawer Rails

1. Remove screws inside plastic rail retainer.
2. Remove rails from retainer by depressing plastic tabs on back side of retainer.
3. Slide rails off of retainer.

### Rack and Pinion Gear

1. Remove drawer assembly (see Drawer Assembly Removal).
2. Extend drawer rails to full open position and remove rails from retainer by depressing plastic tabs on back side of retainer.
3. Slide rails, rack and pinion gear off of retainer.
4. Reverse procedure to reassemble.

Note: When reinstalling rails, rack and pinion gear after latching rails in place, slide rails, rack and pinion to the fully closed position and then pull out to synchronize the rack and pinion gears.

## Bottom of Cabinet

### Front Roller Assembly

1. Remove toe grille by pulling it straight away from unit.
2. Raise front of refrigerator at least 4" off the deck and block it up.
3. Unscrew leveling bolt until wheel is free of leveling bolt.
4. Tip wheel assembly down until wheel assembly will slide out of mount from the rear of assembly.
5. Remove roller assembly from unit.

### Rear Roller Assembly

**NOTE:** Condensate drip pan may spill when steps 1 thru 4 are performed. Have a towel ready to mop up spillage.

1. Tape both doors shut to prevent doors from opening
2. Raise back of refrigerator at least 4" off the deck and block it up.
3. Remove machine-compartment cover.
4. Locate and slide roller pins out of rollers.
5. Install new rollers and reinstall pins.

## Machine Compartment

### Condenser Fan & Fan Motor

1. Remove machine compartment cover.
2. Unplug wiring harness connector from fan motor.
3. On backside of fan motor, screws secure the motor to its brackets. Remove those screws.
4. Press fan blade on to shaft until blade is seated.

### Compressor

**NOTE:** Install new drier and compressor per instructions in "Service Procedures." Evacuate and recharge sealed system per instructions in "Service Procedures."

1. Remove machine compartment cover.
2. Remove drier.
3. Disconnect all compressor wiring and overload/relay assembly.
4. Unbraid low and high pressure lines at compressor.
5. Remove compressor mounting bolts.
6. Lift compressor out of unit.

# Disassembly Procedures



## WARNING

To avoid risk of electrical shock, personal injury, or death, disconnect electrical power source to unit, unless test procedures require power to be connected. Discharge capacitor through a resistor before attempting to service. Ensure all ground wires are connected before certifying unit as repaired and/or operational.

### Overload/Relay/Capacitor

1. Remove machine compartment cover.
2. Using fingers and standard screwdriver, press and pry bale strap off the overload/relay assembly
3. Disconnect wires from overload/relay assembly. Reference wire location.
4. Unplug overload/relay assembly from compressor.

### Condensate Drain Pan

**NOTE:** Condensate drip pan may spill when steps 1 thru 4 are performed. Have a towel ready to mop up spillage.

1. Remove machine compartment cover.
2. Tape both doors shut to prevent doors from opening.
3. Raise back of refrigerator at least 4" off the deck and block it up.
4. Remove rear torx head screws holding base pan and loosen front torx head screws on bottom of cabinet.
5. Carefully lower basepan taking care not to kink tubing to compressor or condenser.
6. Remove hex screws holding condenser fan shroud to basepan.
7. Lift shroud up and out of the way to allow removal of condensate drain pan.
8. Remove drain pan.

### Condensate Drain Tube

1. Remove machine compartment cover.
2. Drip tube is mounted to bottom of cabinet with clip. Reach into machine compartment and squeeze the clip to release drain tube.
3. Pull drip tube down, off drain nipple and back, out of unit.

### Condenser Removal

**NOTE:** Install new drier per instructions in "Service Procedures." Evacuate and recharge sealed system per instructions in "Service Procedures."

1. Remove machine compartment covers.
2. Unbraid tubing going to PC loop and heat exchanger.
3. Disconnect all machine compartment wiring at molex plug to cabinet.
4. Tape both doors shut to prevent doors from opening
5. Raise back of refrigerator at least 6" off the deck and block it up.
6. Remove torx head screws to drop base pan and condenser out of unit.
7. Remove basepan and condenser out of unit.
8. Unbraid discharge and condenser out at condenser.
9. Unsnap condenser from basepan and replace.

### Cabinet Back

#### High Voltage Board

1. Remove 4 hex screws holding high voltage board cover on.
2. Remove plastic lid by prying it out from right side of box.
3. Disconnect harness connections from high voltage board.
4. Unclip high voltage board from retainers.
5. Be sure to return wires to wire slots onto panel bottom of control box.
6. Reverse procedure to reassemble.

**Note:** Take care in handling ESD sensitive parts.  
(Discharge self and handle board on edges)



# Control Board (Fully Electronic)

## WARNING

To avoid risk of electrical shock, personal injury, or death, disconnect electrical power source to unit, unless test procedures require power to be connected. Discharge capacitor through a 10,000 ohm resistor before attempting to service. Ensure all ground wires are connected before certifying unit as repaired and/or operational.

### Programming Mode:

**NOTE:** The Program Code is located on the Serial Plate on this unit after the word Code.

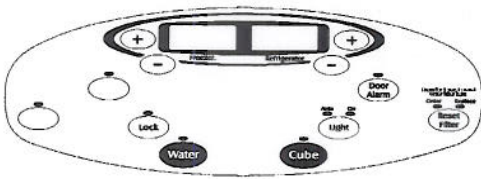

1. Press and hold the Door Alarm Keypad .
2. Press and hold Freezer Temperature Down Keypad .
3. Release the Door Alarm Keypad and wait 3 seconds.
4. The control will display PE to indicate the programming mode.

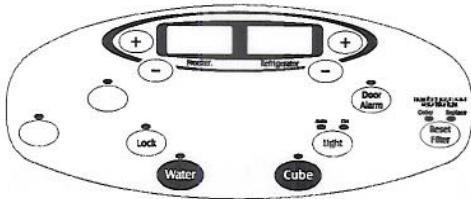

5. Entry is confirmed by pressing the Freezer Temperature Down Keypad  once more.
6. The control will display the current Program CODE. This value should be validated with the Program CODE printed on the unit serial plate.



**NOTE:** If the Program CODE is correct, the Programming Mode is exited by pressing Door Alarm Keypad for 3 seconds.

7. Press the Refrigerator Temperature Up Keypad  or Refrigerator Down Keypad  to change the digit value with each key press.
8. The decimal point indicates the selected digit. Press the Freezer Temperature Up Keypad to select the next digit.
9. Once the desired Program CODE is entered, press and hold the Freezer Temperature Down Keypad until the Program CODE begins flashing indicating it has been saved.

**NOTE:** If you attempt to enter an invalid Program CODE the control will not save the new code, but will beep. (The unit will NOT run with a Program CODE of 0000). Once the Program CODE has been saved the Programming Mode is exited by pressing any key. If the new code is incorrect this process should be repeated.



**The Programming mode can be exited at any time by pressing Door Alarm key for 3 seconds or will exit if unattended for four minutes.**

### Defrost Operation:

The Control Board adapts the compressor run time between defrosts to achieve optimum defrost intervals by monitoring the length of time the defrost heater is on. After initial power up, defrost interval is 4 hours compressor run time. Defrost occurs immediately after the 4 hours.

### Forced Defrost Mode:

The forced defrost function is performed using the Freezer display and Refrigerator keypad. Enter the Forced Defrost Mode by performing the following sequence of events:

1. Press and hold the Door Alarm Keypad .
2. Press and hold Refrigerator Temperature Down Keypad .
3. Release the Door Alarm Keypad and wait 3 seconds. Fd appears in Freezer display

# Control Board (Fully Electronic)



## WARNING

To avoid risk of electrical shock, personal injury, or death, disconnect electrical power source to unit, unless test procedures require power to be connected. Discharge capacitor through a 10,000 ohm resistor before attempting to service. Ensure all ground wires are connected before certifying unit as repaired and/or operational.

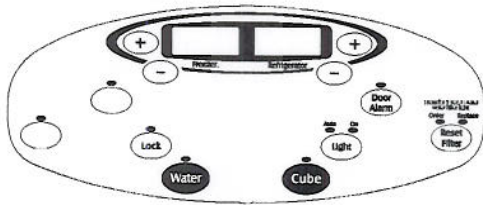

4. Press the Refrigerator Down Keypad (−) again. Sh appears in right display.
5. Press again to force defrost Fd and Sh will flash in display indicating unit is in defrost.

### Service Test Mode:

The service test functions are performed using the refrigerator display and keypad. Enter the Service Test Mode by performing the following sequence of events:

1. Press and hold the Door Alarm Keypad (Door Alarm).
2. Press and hold Refrigerator Temperature Up Keypad (+) within three seconds.
3. Release the Door Alarm Keypad and wait 3 seconds.
4. The Freezer display will display SE confirming entry in the Service Mode.
5. Press the Refrigerator Up Keypad again to confirm entry in the Service Mode.
6. Display will show 101 in left display.
7. Press Freezer Up Keypad and Freezer Down Keypad to toggle through Service Test numbers.

### Service Test – 101 Defrost Heater & Defrost Circuit

Press the Refrigerator Up keypad (+) and Refrigerator Down keypad (−) to energize or de-energize the Defrost circuit. The display will read OFF when de-energized OP when energized with open defrost thermostat and CL when energized with closed defrost thermostat. This will also display dp if damper is moving.

### Service Test – 102 Compressor / Condenser Fan

Press the Refrigerator Up keypad (+) and Refrigerator Down keypad (−) to toggle Compressor/Condenser fan On and Off.

### Service Test – 112 Freezer Fan

Press the Refrigerator Up keypad (+) and Refrigerator Down keypad (−) to toggle Freezer Fan On High speed, Low speed and Off.

**NOTE:** Freezer display will show state 0.0 for OFF, 11.0-14.0 volts for High speed or 7.75- 8.25 volts for Low speed.

### Service Test – 113 Ice Compartment Fan

Press the Refrigerator Up keypad (+) and Refrigerator Down keypad (−) to toggle ice compartment Fan on High speed, Low speed and Off.

**NOTE:** Freezer display will show state 0.0 for OFF, 11.0-14.0 volts for High speed or 7.75- 8.25 volts for Low speed.

### Service Test – 121 Damper Operation

Press the Refrigerator Up keypad and Down keypad to toggle Damper (OP) open and (CL) closed.

**NOTE:** If damper is opening or closing it will not allow you to toggle damper and beep. Display will show state −CL or −OP if Damper is in the process of closing or opening.

### Service Test – 131 Mullion Heater

Press the Refrigerator Up Keypad and Refrigerator Down Keypad to toggle Mullion Heater Off and On.

### Service Test – 141 Fresh Food Thermistor

Will Show Fresh Food Temperature or OP for open thermistor or SH for shorted thermistor.

# Control Board (Fully Electronic)



## WARNING

To avoid risk of electrical shock, personal injury, or death, disconnect electrical power source to unit, unless test procedures require power to be connected. Discharge capacitor through a 10,000 ohm resistor before attempting to service. Ensure all ground wires are connected before certifying unit as repaired and/or operational.

### Service Test – 142 Freezer Thermistor

Will Show Freezer Temperature or OP for open thermistor or SH for shorted thermistor.

### Service Test – 144 Ambient Thermistor

Will Show Ambient Temperature or OP open thermistor or SH shorted thermistor.

### Service Test – 145 Ice Box Thermistor

Will Show Ice Box Temperature or OP open thermistor or SH shorted thermistor.

### Service Test – 151 Fresh Food Door State

Will show state of Fresh Food Door. OP (open) CL (closed).



**NOTE:** By pushing either fresh food door switches you can toggle state from OP (open) to CL (closed).

### Service Test – 152 Freezer Food Door State

Will show state of Freezer Door. OP (open) CL (closed).

**NOTE:** By pushing freezer door switch you can toggle state from OP (open) to CL (closed).

### Service Test – 153 Disable Internal Lights

Press the Refrigerator Up keypad  and Down keypad  to toggle Enable (En) and Disable (DIS) internal.

Note : Turning off this feature will turn off the Auto light shutoff feature

### Service Test – 161 Cube Dispenser

Display shows the state of the Ice Auger Motor (ON or OFF).

**NOTE:** By pushing Actuator pad you can control state of the Ice Auger Motor without opening Ice Chute door.

### Service Test – 163 Water Dispenser

- Display shows the state of the Water Dispenser Valve (ON or OFF).

**NOTE:** By pushing Actuator pad or Front fill you can control state of Water Dispenser Valve.

### Service Test – 164 External Ice Chute Door

Display shows the state of the External Ice Chute Door CL (closed) or OP (open).

**NOTE:** By pushing Actuator pad you can control state of External Ice Chute Door.

### Service Test – 165 Dispenser Lamp

Display shows the state of the Dispenser Lamp (ON or OFF).

**NOTE:** By pushing Actuator pad or Bottle fill you can control state of dispenser lamp.

### Service Test – 166 Internal Ice Chute Door Operation

Display shows the state of the Internal Ice Chute Door CL (closed) or OP (open).

**NOTE:** By pushing Actuator pad you can control state of Internal Ice Chute Door. The ice chute door will activate only when left door switch is closed.

### Service Test – 167 Cavity Heater Test

Display shows the state of the Cavity Heater (ON or OFF).

### Service Test – 171 Actuator Pad

Display shows the state of the Actuator Pad (ON or OFF). Service Test – 172 Bottle Fill (If equipped)

Display shows the state of the Bottle Fill (ON or OFF).

### Service Test – 173 Ambient Light

Display shows light sensor measurement (Hi or Lo) Night light will turn on when light sensor measures Lo.

By changing the sensor's exposure to ambient light you can control the sensor measurement.

# Control Board (Fully Electronic)



## WARNING

To avoid risk of electrical shock, personal injury, or death, disconnect electrical power source to unit, unless test procedures require power to be connected. Discharge capacitor through a 10,000 ohm resistor before attempting to service. Ensure all ground wires are connected before certifying unit as repaired and/or operational.

### Service Test – 175 Dispenser Line

Display shows the state of the Dispenser Line (ON or OFF). When on Dispenser line will measure 12.7 volts.

### Service Test – 182 LED Indicator

#### Operation

Press the Refrigerator Up Keypad  to show operation of LED Indicators. All LED Indicators will flash. Press twice and LED will stop flashing. (This test is not operational at this time.)

### Service Test – 183 Keypad Operation

Display shows a numeric or letter display indicating the last key pressed.



**NOTE:** Refrigerator Up/Down keypads have no effect when pressed and Freezer Up/Down keypads remain operational.

### Service Test – 192 Ice Maker State Test

Display shows the status of the Ice Maker and the Heater (ON or OFF).

When left Fresh Food door is open the Ice Maker cannot be energized, the test will display dr indicating an open Fresh Food door. When the Ice Maker heater is on, the test will display On.

### Service Test – 201 Mullion Heater Override

Press the Refrigerator Up Keypad  or Refrigerator Down Keypad  to change Mullion Heater from cycling on with compressor (Off position) to 100% operation (On Position).

### Service Test – 202 Default Defrost Operation

Press the Refrigerator Up Keypad or Refrigerator Down Keypad to change Defrost Operation from normal adaptive defrost (Off position) to minimum time between defrosts (On position).

### Service Test – 203 Show Temperature Set points



Press the Refrigerator Up Keypad or Refrigerator Down Keypad to change from showing actual temperature (Off position) to show temperature set points only (On position).

### Service Test – 211 Fresh Food Temperature Adjustment

Press the Refrigerator Up Keypad or Down Keypad to change calibration of Fresh Food Temperature plus or minus in 1°F increments up to ± 6°F.

**NOTE:** Temperature will read in Fahrenheit regardless of what current temperature scale is being used.

### Service Test – 212 Freezer Temperature Adjustment

Press the Refrigerator Up Keypad  or Down Keypad  to change calibration of Freezer Temperature plus or minus 1°F in increments up to ± 6°F.

**NOTE:** Temperature will read in Fahrenheit regardless of what current temperature scale is being used.

### Service Test – 213 Ice Compartment Temperature Adjustment

Press the Refrigerator Up Keypad or Down Keypad to change calibration of Ice Compartment Temperature plus or minus 1°F in increments up to 0° to + 8°F.

**NOTE:** Temperature will read in Fahrenheit regardless of what current temperature scale is being used.

### Service Test – 231 Water Filter Usage

Display shows the percent water filter consumption. 100% indicates the filter should be replaced.

# Control Board (Fully Electronic)



## WARNING

To avoid risk of electrical shock, personal injury, or death, disconnect electrical power source to unit, unless test procedures require power to be connected. Discharge capacitor through a 10,000 ohm resistor before attempting to service. Ensure all ground wires are connected before certifying unit as repaired and/or operational.

### **Service Test – 232 Water Filter Days In Use**

Display shows the number of days since the filter was installed.

### **Service Test – 241 Software Revision Main Control Board**

Display shows the Software revision of the Main Control Board.

### **Service Test – 244 Software Revision Display Board**

Display shows the Software revision of the Display Board.

### **Showroom Mode**

Note: Read Instructions Before Beginning Procedure. Holding Keypad for more than 3 seconds in steps 1 or 2 will advance to the "User Preference Menu".

1. Press and Hold Door Alarm Keypad for one second.
2. While still holding the Door Alarm Keypad Press and Hold the Freezer Temperature Up Keypad for one second, then release the Door Alarm Keypad while still holding the Freezer Temperature Up Keypad. In approximately three seconds, "SH" will appear in the Freezer Temp window.
3. Press Freezer Temp Up once more, and "OFF" will appear in the Fresh Food Temp window.
4. Press Fresh Food Temp Up Keypad to "toggle" the Showroom Mode ON and OFF.
5. While "ON" is in the Fresh Food Display, Press Freezer Temp Up Keypad to "Enter" and "Exit" the Showroom Mode. \*The display will flash confirming Showroom Mode selected.
6. Press any Keypad to display "set point" temperatures, while still remaining in the Showroom Mode.



# Amana®

Ice & Water in French Door

## Refrigerator

### Use & Care Guide



Important Safety Instructions ..... 1-2



Quick Reference Guide..... 3



Installation ..... 4-9



Using the Controls ..... 10-11



Ice And Water .....12-13



Water Filter ..... 14-15



Fresh Food Features..... 16-17



Freezer Features ..... 18



Food Storage Tips ..... 19-21



Care and Cleaning ..... 22-25



Operating Sounds..... 26



Troubleshooting ..... 27-30



# Important Safety Instructions

**Installer:** Please leave this guide with this appliance.

**Consumer:** Please read and keep this Use & Care Guide for future reference; it provides the proper use and maintenance information.

Keep sales receipt and/or canceled check as proof of purchase.

Call: 1-800-688-9900 USA  
1-800-688-2002 Canada

Have complete model and serial number identification of your refrigerator. This is located on a data plate inside the refrigerator compartment, on the upper right side. Record these numbers below for easy access.

Model Number \_\_\_\_\_

Serial Number \_\_\_\_\_

Date of Purchase \_\_\_\_\_

In our continuing effort to improve the quality and performance of our appliances, it may be necessary to make changes to the appliance without revising this guide.

## What You Need to Know About Safety Instructions

Warning and Important Safety Instructions appearing in this guide are not meant to cover all possible conditions and situations that may occur. Common sense, caution and care must be exercised when installing, maintaining or operating appliance.

Always contact the manufacturer about problems or conditions you do not understand.

## Recognize Safety Symbols, Words, Labels

### DANGER

**DANGER** – Immediate hazards which **WILL** result in severe personal injury or death.

### WARNING

**WARNING** – Hazards or unsafe practices which **COULD** result in severe personal injury or death.

### CAUTION

**CAUTION** – Hazards or unsafe practices which **COULD** result in minor personal injury or property damage.

### DANGER

**To reduce risk of injury or death, follow basic precautions, including the following:**

**Important:** Child entrapment and suffocation are not problems of the past. Junked or abandoned refrigerators are still dangerous – even if they sit out for “just a few days.” If you are getting rid of your old refrigerator, please follow the instructions below to help prevent accidents.

*Before you throw away your old refrigerator or freezer:*

- Take off the doors.
- Leave the shelves in place so children may not easily climb inside.

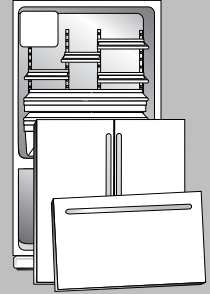

This appliance is equipped with a three-prong grounding plug for your protection against possible electrical shock hazards. It must be plugged into a grounding receptacle. Where a standard two-prong wall receptacle is encountered, it is the personal responsibility and obligation of the customer to have it replaced with a properly grounded three-prong wall receptacle. **Do not under any circumstances, cut or remove the third (ground) prong from the power cord. Do not use an adapter plug.**

Power supply cord with three-prong grounding plug

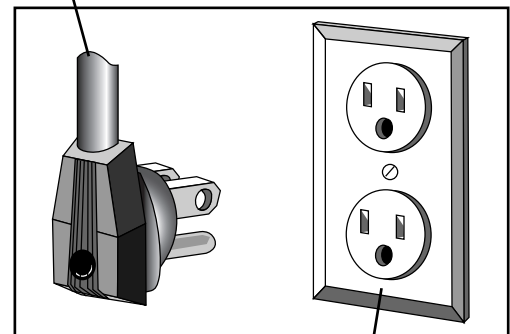

Grounding type wall receptacle



# Important Safety Instructions

## ⚠ WARNING

**To reduce risk of fire, electric shock, serious injury or death when using your refrigerator, follow these basic precautions, including the following:**

1. Read all instructions *before* using the refrigerator.
2. Observe all local codes and ordinances.
3. Be sure to follow grounding instructions.
4. Check with a qualified electrician if you are not sure this appliance is properly grounded.
5. **Do not** ground to a gas line.
6. **Do not** ground to a cold-water pipe.
7. Refrigerator is designed to operate on a separate 115 volt, 15 amp., 60 cycle line.
8. **Do not** modify plug on power cord. If plug does not fit electrical outlet, have proper outlet installed by a qualified electrician.
9. **Do not** use a two-prong adapter, extension cord or power strip.
10. **Do not** remove warning tag from power cord.
11. **Do not** tamper with refrigerator controls.
12. **Do not** service or replace any part of refrigerator unless specifically recommended in Use and Care Guide or published user-repair instructions.  
**Do not** attempt service if instructions are not understood or if they are beyond personal skill level.
13. Always disconnect refrigerator from electrical supply *before* attempting any service. Disconnect power cord by grasping the plug, not the cord.
14. Install refrigerator according to Installation Instructions. All connections for water, electrical power and grounding must comply with local codes and be made by licensed personnel when required.
15. Keep your refrigerator in good condition. Bumping or dropping refrigerator can damage refrigerator or cause refrigerator to malfunction or leak. If damage occurs, have refrigerator checked by qualified service technician.
16. Replace worn power cords and/or loose plugs.
17. Always read and follow manufacturer's storage and ideal environment instructions for items being stored in refrigerator.
18. Your refrigerator **should not** be operated in the presence of explosive fumes.
19. Children **should not** climb, hang or stand on any part of the refrigerator.
20. Clean up spills or water leakage associated with water installation.

**SAVE THESE INSTRUCTIONS**



# Quick Reference Guide

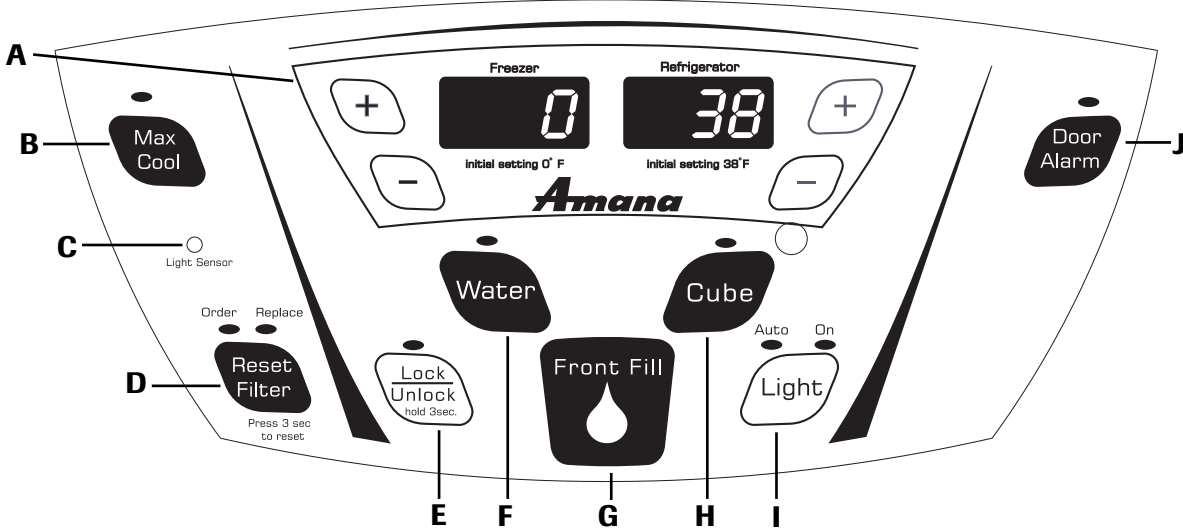

## Quick Reference Guide

<b>A</b> Temperature Control	Use to control the temperature in the refrigerator and freezer compartments. Temperatures are preset at the factory at 38° F (3° C) in the refrigerator compartment and 0° F (-17° C) in the freezer compartment.
<b>B</b> Max Cool	Use to quickly drop compartment temperatures to minimum settings. To <i>activate</i> : press pad. To <i>deactivate</i> : press pad again.
<b>C</b> Light Sensor	Senses light level within the room.
<b>D</b> Reset Filter	Use as a reminder to order or replace the filter. Press and hold the pad for <i>three</i> seconds to turn off lights.
<b>E</b> Lock/Unlock	Use to lock all functions. To <i>activate</i> : press until green light illuminates. To <i>deactivate</i> : press and hold the pad for <i>three</i> seconds until green light turns off.
<b>F</b> Water	Use to select water.
<b>G</b> Front Fill	Use to fill large items that will not fit in dispenser area. Push the pad to use. To dispense ice and water simultaneously, choose Cube mode, then press container against dispenser pad while pressing the <b>Front Fill</b> pad.
<b>H</b> Cube	Use to select ice.
<b>I</b> Light	Use to activate or deactivate the light. Press pad <i>once</i> for Auto, <i>twice</i> for Continuous or <i>three</i> times to deactivate.
<b>J</b> Door Alarm	Indicates the door has been left open. Close the door or press the <b>Door Alarm</b> pad to deactivate the feature.

See pages 10-11 for more information on controls.



# Installation

Your refrigerator was packed carefully for shipment. Remove and discard shelf packaging and tape. **Do not** remove the serial plate.

## Location

- **Do not** install refrigerator near oven, radiator or other heat source. If not possible, shield refrigerator with cabinet material (contact a qualified contractor).
- **Do not** install where temperature falls below 55° F (13° C) or rises above 110° F (43° C). Malfunction may occur at this temperature.
- **Refrigerator is designed for indoor household application only.**

## Measuring the Opening

When installing your refrigerator, measure carefully. Allow ½" space at top and ½" space behind the machine compartment cover (located in the rear) for proper air circulation.

Subflooring or floor coverings (i.e. carpet, tile, wood floors, rugs) may make your opening smaller than anticipated.

Some clearance may be gained by using the leveling procedure under *Leveling*.

**Important:** If refrigerator is to be installed into a recess where the top of the refrigerator is completely covered, use distance from floor to top of hinge cap to verify proper clearance.

## Transporting Your Refrigerator

- **NEVER** transport refrigerator on its side. If an upright position is not possible, lay refrigerator on its back. Allow refrigerator to sit upright for approximately 30 minutes *before* plugging it in to assure oil returns to the compressor. Plugging the refrigerator in immediately may cause damage to internal parts.
- Use an appliance dolly when moving refrigerator. **ALWAYS** truck refrigerator from its side or back—**NEVER** from its front.
- Protect outside finish of refrigerator during transport by wrapping cabinet in blankets or inserting padding between the refrigerator and dolly.
- Secure refrigerator to dolly firmly with straps or bungee cords. Thread straps through handles when possible. **Do not** over-tighten. Over-tightening restraints may dent or damage outside finish.

## Leveling

To enhance the appearance and maintain performance, the refrigerator should be level.

### ⚠ CAUTION

**To protect property and refrigerator from damage, observe the following:**

- Protect vinyl or other flooring with cardboard, rugs, or other protective material.
- **Do not** use power tools when performing leveling procedure.

### Notes:

- Complete any required water supply connection *before* leveling.
- Some models only have adjustment screws "A".

### Materials Needed:

- ⅜" hex head driver
- Carpenter's level.

1. Remove toe grille.

- Grasp firmly and pull outward to unclip.

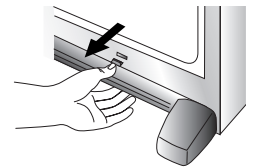

2. Using hex head driver, turn the front adjustment screws (A) on each side to raise or lower the front of the refrigerator (see illustration below).



3. Using the hex head driver, turn each of these adjustment screws (B) to raise or lower the rear of the refrigerator.

4. Using a carpenter's level, make sure front of refrigerator is ¼" (6 mm) or approximately ½ bubble higher than back of refrigerator and that the refrigerator is level from side to side.

5. Turn stabilizing legs (C) *clockwise* until firmly against floor.

6. Turn adjustment screws (A) *counterclockwise* to allow the full weight of the refrigerator to rest on the stabilizing legs.

7. Replace the toe grille.

- Align the toe grille mounting clips with the lower cabinet slots.
- Push the toe grille firmly until it snaps into place.



# Installation

## Door and Drawer Removal

Some installations require door/drawer removal to transport the refrigerator to its final location.

### ⚠ WARNING

To avoid electrical shock which can cause severe personal injury or death, observe the following:

- Disconnect power to refrigerator *before* removing doors or drawer. Connect refrigerator door wire harness and power *only after* replacing doors or drawer.

### ⚠ CAUTION

To avoid damage to walls and flooring, protect vinyl or other flooring with cardboard, rugs or other protective material. Monitor water connection for 24 hours. Correct leaks if necessary.

**Note:** For refrigerators in operation, shut off water *before* removing water line from the door.

1. Unplug power cord from power source.
2. Remove toe grille (see page 4).

3. Remove top hinge cover from right side refrigerator door by removing Phillips screws. Retain screw and cover for later use.

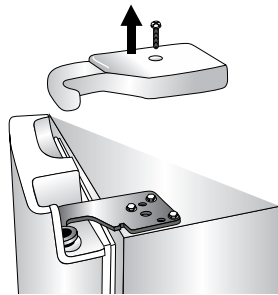

4. Unscrew  $\frac{5}{16}$ " hex head screws from top hinge to remove hinge and retain all screws for later use.

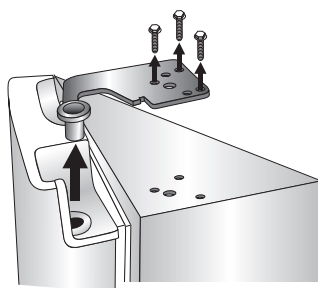

5. Lift right side refrigerator door from center hinge pin. Remove door closure from center hinge pin on the right side and retain for later use.

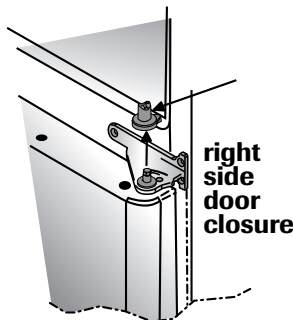

6. Remove top hinge cover from left side refrigerator door by removing Phillips screws. Retain screws and cover for later use.

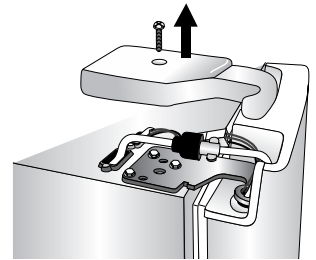

7. Disconnect wire harness on top left side of refrigerator door top hinge. Release connector by pressing junction point with a flat blade screwdriver or fingernail.

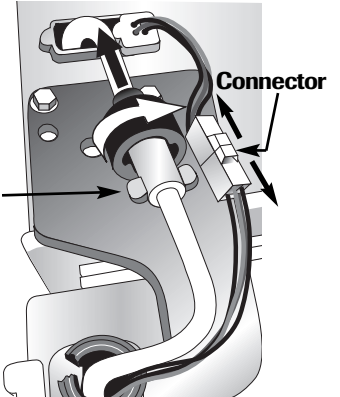

8. Disconnect water line. Hold "tabbed" section of waterline while rotating the black locking collar *clockwise* and slide back.

9. Unscrew  $\frac{5}{16}$ " hex head screws from top hinge to remove hinge; retain for later use.

10. Lift left side refrigerator door, along with top hinge, from center hinge pin.

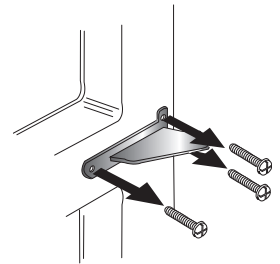

11. Remove center hinge pin with a  $\frac{5}{16}$ " hex head driver and retain hinge pin for later use.

12. Remove Phillips screws to remove right and left hinges; retain all screws for later use.

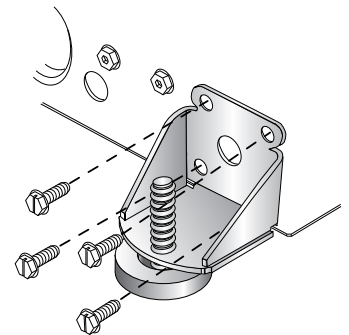

13. Remove both stabilizing brackets with  $\frac{3}{8}$ " hex head driver; retain screws for later use.



# Installation

## Door Reinstallation

1. Install hinge assemblies:
  - Install center hinge with Phillips screws.
2. Place hinge side of refrigerator door on center hinge pin.
  - Install top hinge with  $\frac{5}{16}$ " hex head screws.
3. While holding refrigerator door upright, tighten down top hinge with  $\frac{5}{16}$ " hex head driver.

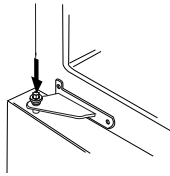

4. Reconnect connector.
5. Connect the waterline tubes firmly by pushing one waterline inside the other.
6. Slide the black locking collar fully forward.
7. Hold tabbed section of waterline.
8. Rotate black locking collar *counterclockwise* locking water lines in place. A "click" is heard ensuring waterlines are correctly locked in place. The "arrow" on the tabbed section should align with the 2 bars on the black locking collar.
9. Ensure the connection does not leak *before* installing the upper hinge cover.
10. Replace top hinge covers.

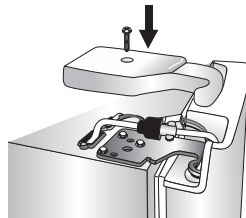
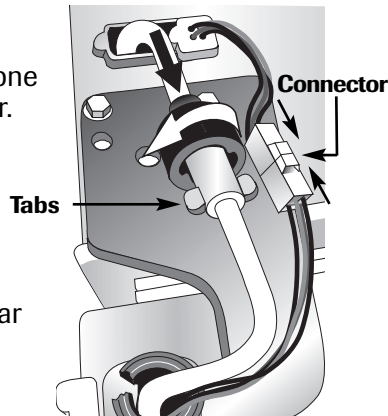

## Pullout Freezer Drawer

### ⚠ WARNING

To avoid electrical shock which can cause severe personal injury or death, disconnect power to refrigerator *before* removing doors. After replacing doors, connect power.

### ⚠ CAUTION

To avoid possible injury, product, or property damage, you will need two people to perform the following instructions. **Important: Always** unload food in freezer trays *before* removing trays.

### To Remove:

1. Pull drawer open to full extension.
2. Slide freezer drawer forward and lift straight out.
3. Remove Phillips screws from each of the drawer slides.

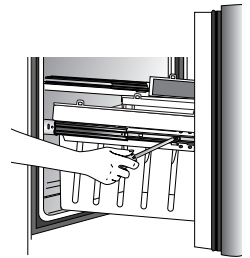
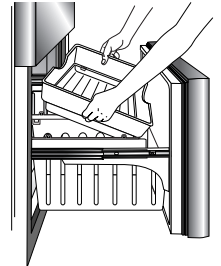

4. Lift top of drawer front to unhook the drawer from the slides.

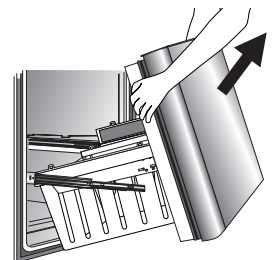

5. Move drawer slides fully forward.

6. Lift out lower drawer assembly.

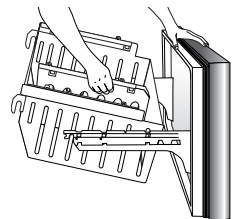



# Installation

## To Install:

1. Pull both rails out to full extension.
2. While supporting door front, hook supports into slots located on inside of each slide.

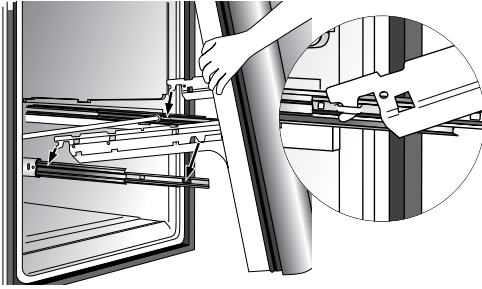
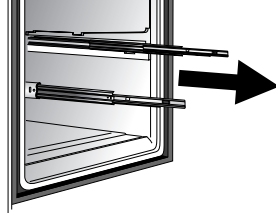

**Note:** All four drawer bracket supports must be in the proper slots for the drawer to function properly (see inset for detail).

3. Lower door front into final position.
4. Replace and tighten Phillips screws that were removed from the drawer slides.
5. Install the lower assembly by aligning hooks of lower drawer assembly with rear rail on freezer drawer.
6. Replace freezer drawers. Align the large square notches on outside of the drawer slides.

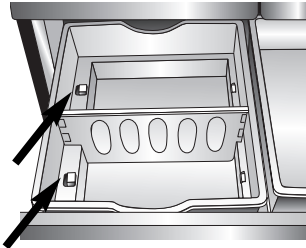
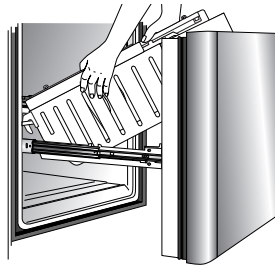

## Handles

**Note:** If not installed, the handle is located in the interior of the fresh food compartment or attached to the back of your refrigerator.

### Plastic Handle

#### To Remove:

1. Grasp the lower part of the handle firmly, slide *up*, lift and remove from the surface.

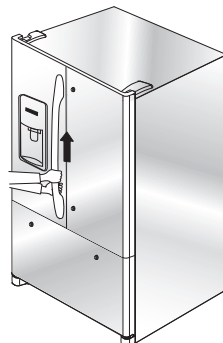

## To Install:

1. The handles are to be oriented as shown.
2. Align door handle clip with the door studs.
3. Ensure the large hole in the mounting clip is positioned *down* on both ends of the handle.
4. Rotate the handle so that the handle is flat against the door.
5. Grasp the handle firmly and slide *down*.

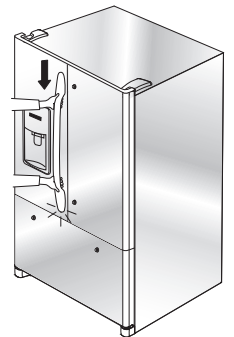
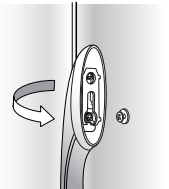
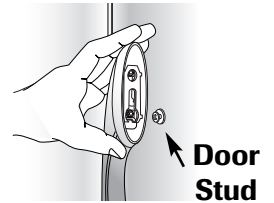
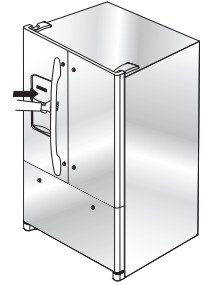

## Freezer Handle

### Notes:

- Select models have a slight curve to the freezer handle.
- For proper installation, be sure handle is oriented as shown.

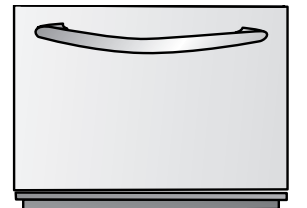

#### To Install:

1. Align door handle clips to the studs attached to the freezer door.
2. Ensure the large hole in the mounting clip is positioned to the *right* on both ends of the handle.

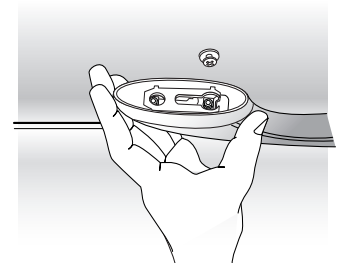





# Installation

3. Rotate the handle so that the handle is flat against the door.
4. Grasp the handle firmly and slide handle to the *right* and remove from surface.

## To Remove:

1. With both hands, firmly grasp the handle toward the right side.
2. Slide toward the *left*, lift and remove from the surface.

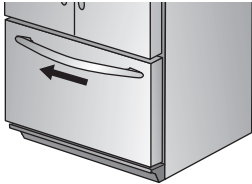

## Metal Handle

### Materials Needed:

- $\frac{3}{32}$ " Allen wrench
- Gloves to protect hands

**Note:** Metal handles can scratch doors.

### To Remove:

- Loosen set screws in handle using  $\frac{3}{32}$ " Allen wrench.
- Repeat the procedure on all screws.

### To Replace:

- Align handle with the mounting posts.
- Fully tighten all set screws to secure handle in place.

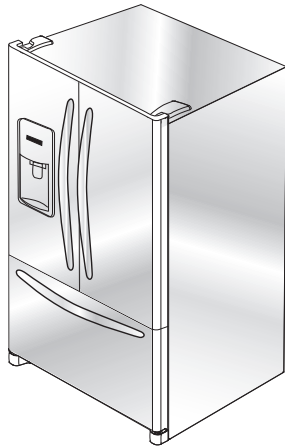

## Connecting the Water Supply

### ⚠ WARNING

To reduce the risk of injury or death, follow basic precautions, including the following:

- Read all instructions *before* installing ice maker.
- **Do not** attempt installation if instructions are not understood or if they are beyond personal skill level.
- Observe all local codes and ordinances.
- **Do not** service ice maker unless specifically recommended in Use and Care Guide or published user-repair instructions.
- Disconnect power to refrigerator *before* installing ice maker.
- Water damage due to an improper water connection may cause mold/mildew growth. Clean up spills or leakage immediately!

### ⚠ CAUTION

To avoid property damage or possible injury, follow basic precautions, including the following:

- Consult a plumber to connect  $\frac{1}{4}$ " **O.D. copper tubing** to household plumbing to assure compliance with local codes and ordinances.
- Confirm water pressure to water valve is between 35 and 100 pounds per square inch, 20 pounds per square inch without filter.
- **Do not** use a self-piercing, or  $\frac{3}{16}$ " saddle valve. Both reduce water flow and can become clogged over time, and may cause leaks if repair is attempted.
- Tighten nuts by hand to prevent cross threading. Finish tightening nuts with pliers and wrenches. **Do not** over-tighten.
- Wait two to three hours *before* placing refrigerator into final position to check and correct any water leaks. Recheck for leaks after 24 hours.
- Verify the copper tubing under the sleeve is smooth and free from defects. **Do not** reuse an old sleeve.



# Installation

## Materials Needed:

- ¼" outer diameter flexible copper tubing
- Shut-off valve (requires a ¼" hole to be drilled into water supply line *before* valve attachment)
- Adjustable wrenches (2)
- ¼" hex nut driver

## Notes:

- Use only copper tubing for installation. Plastic is less durable and can cause damage.
- Add 8' to tubing length needed to reach water supply for creation of service loop.

1. Create service loop with copper tubing (minimum 2' diameter). Avoid kinks in the copper tubing when bending it into a service loop. **Do not** use plastic tubing.

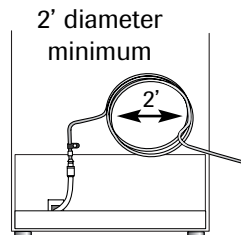

2. Remove plastic cap from water valve inlet port.

3. Place brass nut (A) and sleeve (B) on copper tube end as illustrated. **Reminder: Do not** use an old sleeve. The nut and sleeve are provided in the Use and Care packet.

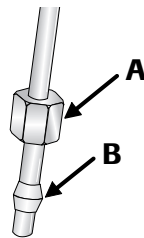

4. Place end of copper tubing into water valve inlet port.
5. Slide brass nut over sleeve and screw nut into inlet port. Tighten nut with wrench.

(1) Place adjustable wrench on nut attached to plastic waterline and maintain position.

(2) Using second adjustable wrench turn the upper nut *clockwise* and fully tighten while holding the lower nut in place.

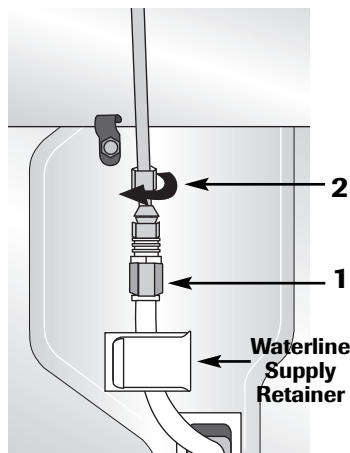

6. Pull on tubing to confirm connection is secure. Connect tubing to frame with water tubing clamp (C). Slide waterline into retainer, then turn on water supply. Check for leaks and correct if necessary. Continue to observe the water supply connection for two to three hours prior to moving the refrigerator to its permanent location.

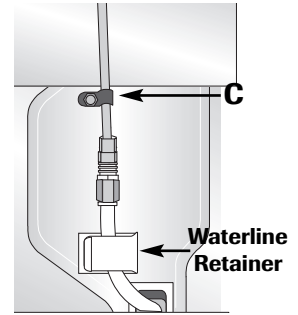

7. Monitor water connection for 24 hours. Correct leaks, if necessary.

## Opening and Closing Your Fresh Food Doors

Your new refrigerator is uniquely designed with two fresh food doors. Either door can be opened or closed independently of one another.

For proper usage and to avoid possible damage, *always* ensure the vertical hinged section (on the left fresh food door) remains folded inward *before* closing both doors. When both doors are closed, the hinged section automatically forms a seal between the two doors.

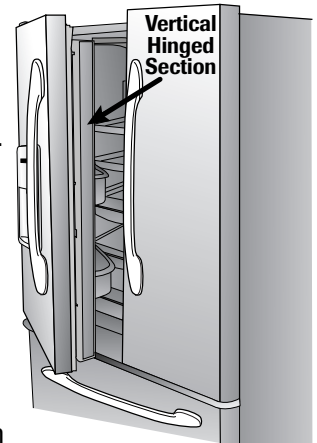

When the left door is opened, the vertical hinged section automatically folds inward so that it is out of the way.

### ⚠ WARNING

To avoid electrical shock which can cause severe personal injury or death, **DO NOT** attempt to remove the vertical hinged section from the fresh food section.

### ⚠ CAUTION

To avoid possible product damage, **ALWAYS** verify that the vertical hinged section is folded against the edge of the door prior to closing.

**Important: Do not** over-tighten. Cross threading may occur.



# Using the Controls

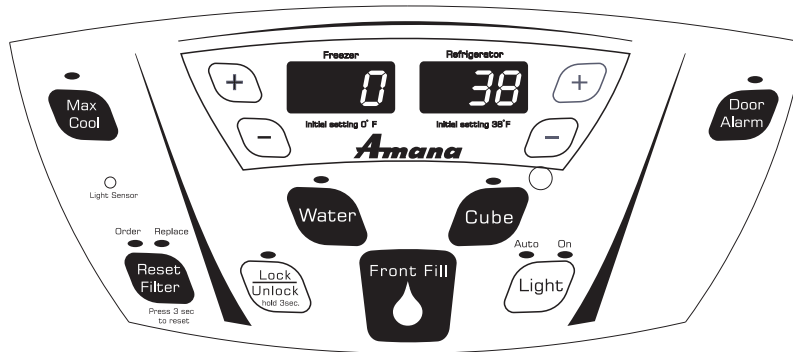

## Initial Temperature Setting

Temperatures are preset at the factory at 38° F (3° C) in the fresh food compartment and 0° F (-18° C) in the freezer compartment.

## Adjusting the Control

24 hours after adding food, you may decide that one or both compartments should be colder or warmer. If so, adjust the control as indicated in the *Temperature Control Guide* below.

- **Do not** change either control more than one degree at a time. Allow temperature to stabilize for 24 hours before making a new temperature adjustment.

## Temperature Control Guide

<b>Refrigerator too cold</b>	Set the Refrigerator control to next higher number by pressing the (+) pad.
<b>Refrigerator too warm</b>	Set the Refrigerator control to next lower number by pressing the (-) pad.
<b>Freezer too cold</b>	Set the Freezer control to next higher number by pressing the (+) pad.
<b>Freezer too warm</b>	Set the Freezer control to next lower number by pressing the (-) pad.
<b>Turn refrigerator off</b>	Press the <b>Freezer</b> (+) pad until "OFF" appears in the display. Press the (-) in either the freezer or refrigerator section to turn back on.

## Front Fill Button (select models)



The Front Fill Button works independently of the dispenser controls, providing an up-front alternative to the dispenser pad for dispensing water. This feature is convenient for filling large items that will not fit into the dispenser area (i.e. sport bottles, pitchers, large pans, coffee pots). This feature allows added convenience of dispensing ice and water simultaneously. To use, choose Cube mode from dispenser control panel. Press container against dispenser pad while pressing the **Front Fill** button.

## Water Filter Status Indicator Light



When a water filter has been installed in the refrigerator, the yellow Order light will illuminate when 90 percent used OR 11 months have elapsed since the filter has been installed.

The red Replace light will illuminate when the rated volume of water has passed through the filter OR 12 months have elapsed since the filter was installed. A new filter should be installed immediately when the Replace light is illuminated.

After replacing the filter, press and hold the **Reset Filter** pad for *three* seconds. The Order and Replace lights will go off.

## Light



The Light feature can be used to provide light to the dispenser area. The light feature is automatically activated and the indicator light illuminates. There are two methods available for lighting the dispenser - Auto and Continuous.

The Auto light function activates the dispenser light at *half-power* when the light sensor detects that the light levels in the room are low.

The Continuous light function provides light until deactivated. The On indicator light will illuminate.

## To Activate Auto Light:

Press the **Light** pad *once*. The Auto indicator will illuminate.

Cont.



# Using the Controls

## To Activate Continuous Light:

Press **Light** pad again. The On indicator light will illuminate.

## To Deactivate Auto or Continuous Light:

Press the **Light** pad a *third* time. This will turn off the dispenser and indicator light.

## Door Alarm



The Door Alarm feature will alert you when one of the doors has been left open for approximately three minutes. When this happens, the Door Alarm light will flash and an audible alarm will sound.

### To Activate:

Press the **Door Alarm** pad *once*. The Door Alarm indicator light will illuminate.

### To Deactivate:

Press the **Door Alarm** pad *once*. The indicator light will go off.

### To Turn Off the Audible Alarm:

Press the **Door Alarm** pad *once* or close the door.

## Max Cool



The Max Cool feature is automatically activated and the indicator light illuminates. This feature provides the ability to cool down the refrigerator and freezer after extended door openings or when loading either compartment with warm food. This feature causes the refrigerator and freezer temperatures to drop to the minimum settings on the control. **Important:** When the Max Cool feature is in operation, the **+** and **-** pads for the Refrigerator and Freezer controls will not operate.

### To Activate:

Press the **Max Cool** pad *once*. The Max Cool indicator light will illuminate.

### To Deactivate:

Press the **Max Cool** pad *once*. The indicator light will go off.

Max Cool will deactivate automatically after 2 hours.

## User Preferences

### Access the User Preferences menu to:

- Change the temperature display from °F to °C.
- Enable or disable audible alarms.
- Adjust the light level at which the Dispenser Auto Light will illuminate when this feature is activated on the ice and water dispenser.

- Activate the Sabbath Mode.

To access the User Preferences menu, press and hold the **Door Alarm** pad for *three* seconds. When in the User Preferences mode, a short title for the feature will appear in the Freezer temperature display and the feature status will appear in the Refrigerator display.

1. Use the Freezer **+** and **-** control to scroll through the features.
2. When the desired feature is displayed, use the Refrigerator **+** and **-** control to change the status.
3. When changes are complete, press the **Door Alarm** pad for *three* seconds OR close the Refrigerator door.

## Temperature Display (F\_C)

Change the display to show temperatures in degrees Fahrenheit or degrees Celsius.

## Alarm (AL)

When the Alarm mode is off, all audible alarms will be disabled until the feature is turned on.

## Auto Light Level Selection (LL)

This setting adjusts the light level at which the dispenser light will illuminate when the sensor detects that the light levels in the room are low. Setting 1 is the darkest light level setting, setting 9 is the brightest light level setting. **Important:** The Auto Light must be activated on the ice and water dispenser control to take advantage of this option.

## Sabbath Mode (SAB)

When the Sabbath Mode is on, all control lights, interior lights, and the night light will be disabled until the feature is turned off. Press the **Door Alarm** pad for *three* seconds to restore the lights.

### Notes:

- Dispenser light will not activate during dispensing while in Sabbath Mode.
- If the power fails, the control will remain in Sabbath Mode when power returns.

## Warm Cabinet Surfaces

At times, the front of the refrigerator cabinet may be warm to the touch. This is a normal occurrence that helps prevent moisture from condensing on the cabinet. This condition will be more noticeable when the refrigerator is first started, during hot weather and after excessive or lengthy door openings.

# Ice and Water

**Note:** During initial use of water dispenser and ice maker, there will be a one to two minute delay while water tank fills before water dispenses or ice is made. Discard first 10-14 glasses of water after initially connecting refrigerator to household water supply. Additional flushing may be required in some households where water is of poor quality.

## Ice and Water Dispenser

### To Use Dispenser Paddle:

- Choose **Water** selection from dispenser control panel.
- Press a sturdy, wide-mouthed container against dispenser paddle.
- Release pressure on dispenser paddle to stop water dispensing. A small amount of water may continue to dispense and collect in dispenser tray. Large spills should be wiped dry.

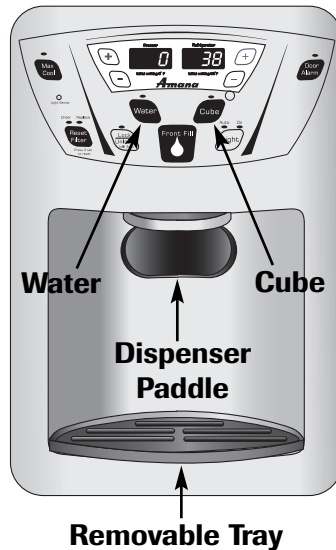

### Removable Tray

The removable tray at the bottom of the dispenser area is designed to collect small spills and may be easily removed for cleaning and emptying purposes.

**Important:** Removable tray does not drain. **Do not** allow tray to overflow. If it does, remove tray and wipe up overflow.

### To Dispense Ice and Water:

- Select **Water**, or **Cube** ice mode by pushing button on dispenser control panel. A green light above button indicates mode selection.
- Press container against dispenser paddle. When dispensing ice, hold container as close to chute as possible to reduce spraying.

**Notes:** If dispenser is active for more than five minutes, an automatic lock out sensor will shut down power to dispenser area. See *Dispenser Lock/Unlock* for unlocking information.

### Dispenser Lock/Unlock

The Dispenser Lock/Unlock prevents ice or water from being dispensed.



### To Lock Dispenser:

- Press and hold the **Lock/Unlock** button for *three* seconds. A green indicator light above the button will illuminate when the dispenser is locked.

### To Unlock Dispenser:

- Hold the **Lock/Unlock** button for *three* seconds. The green indicator light above will go out.

## Automatic Ice Maker

Connect the ice maker to the water supply as instructed on pages 8-9. **Proper water flow and a level refrigerator are essential for optimal ice maker performance.**

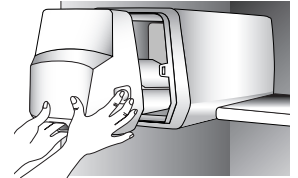

### Ice Storage Bin

The ice storage bin is located below the automatic ice maker in the upper left side enclosure of the fresh food compartment.

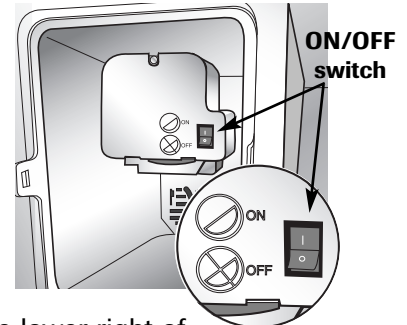

### To Remove:

- Depress the button on the lower right of the ice storage bin to release from the enclosure. Continue pulling until resistance is felt. Lift up front of ice bin and remove. Press the switch on the front of the ice maker to turn the ice maker off.

**Important:** **Do not** remove ice storage bin without pressing ice maker switch to **OFF**. Removing ice storage bin while ON could result in ice falling into the ice storage bin enclosure, blocking the dispenser and disabling the bin from being locked into proper position.

**Note:** Access to the ice storage bin will be limited with the left fresh food door opened at 90 degrees. Move cabinet forward to enable door to open sufficiently for ice storage bin access.

### To Install:

**Important:** Ice bin must be locked in place for proper ice dispensing. If necessary, turn auger driver behind ice bin *counterclockwise* to properly align ice bin with auger driver.





# Ice and Water

- Press the switch **ON** to activate ice maker. Slide bin into guide rails located on either side of the enclosure. Push the ice bin in until resistance is felt. Raise the front slightly and push the ice bin completely in. **An audible “click” is heard when the ice bin is located correctly.**

## Operating Instructions

- Confirm ice bin is in place.
- After freezer section reaches between 0° to 2° F (-18° to -17° C), ice maker fills with water and begins operating. You will have a complete harvest of ice approximately every hour.
- Allow approximately 3 to 6 hours after installation to receive first harvest of ice.
- Discard ice created within the first 12 hours of operation to verify system is flushed of impurities.
- Stop ice production by pressing the **ON/OFF** switch located on the front of the ice maker.
- The first one or two batches will probably contain undersized and irregular cubes because of air in the supply line.
- When the ice cubes are ejected it is normal for several cubes to be joined together at the ends. They can easily be broken apart. The ice maker will continue to make ice until the supply of ice cubes raises the ice maker arm, shutting the ice maker off.
- Certain sounds may accompany the various cycles of the ice maker. The motor may have a slight hum, the cubes will rattle as they fall into an empty storage pan and the water valve may click or “buzz” occasionally.
- If the ice is not used frequently, the ice cubes will become cloudy, shrink, stick together and taste stale. Empty the ice storage bin periodically and wash it in lukewarm water. Be sure to dry the bin thoroughly *before* replacing it.
- Beverages and foods **should not** be placed in the ice storage bin for quick chilling. These items can cause the ice maker to malfunction.
- Press the switch on the ice maker front to **OFF** when the water supply is to be shut off for several hours.

## ⚠ WARNING

**To avoid personal injury or property damage, observe the following:**

- **Do not** place fingers or hands on the automatic ice making mechanism while the refrigerator is plugged in. This will help protect you from possible injury. It will also prevent interference with moving parts of the ejector mechanism and the heating element that releases the cubes.
- Under certain rare circumstances, ice cubes may be discolored, usually appearing with a green-bluish hue. The cause of this unusual discoloration can be a combination of factors such as certain characteristics of local waters, household plumbing and the accumulation of copper salts in an inactive water supply line which feeds the ice maker. Continued consumption of such discolored ice cubes may be injurious to health. If such discoloration is observed, discard the ice cubes and contact your dealer to purchase and install a water line filter.
- Water damage due to improper water connection may cause mold/mildew growth.
- Clean up water and ice spills to avoid personal injury and to prevent mold/mildew growth.
- **Do not** dispense ice directly into thin glass, fine china or delicate crystal.



# Water Filter

## Water Filter Removal and Installation

### ⚠ WARNING

To avoid serious illness or death, **do not** use refrigerator where water is unsafe or of unknown quality without adequate disinfection before or after use of filter.

### ⚠ CAUTION

**After installing a new water filter, always dispense water for two minutes before removing the filter for any reason. Air trapped in system may cause water and cartridge to eject. Use caution when removing.**

- The bypass cap does not filter water. Be sure to have replacement cartridge available when filter change is required.
- If water filtration system has been allowed to freeze, replace filter cartridge.
- If system has not been used for several months, or water has an unpleasant taste or odor, flush system by dispensing water for two to three minutes. If unpleasant taste or odor persists, change filter cartridge.

## Initial Installation

The water filter is located in the upper right-hand corner of the fresh food compartment.

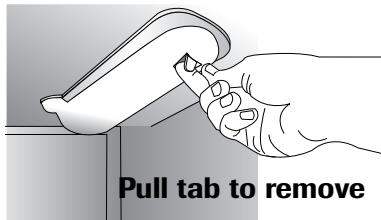

Pull tab to remove

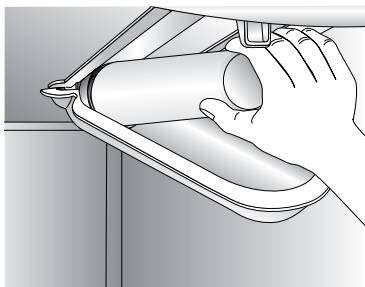

1. Remove blue bypass cap and retain for later use.
2. Remove sealing label from end of filter and insert into filter head.
3. Rotate gently *clockwise* until filter stops. Snap filter cover closed.

## Replacing Water Filter

**Important: Air trapped in system may cause water and cartridge to eject. Always dispense water for at least 2 minutes before removing the filter for any reason. Use caution when removing.**

1. Turn filter *counterclockwise* until it releases from filter head.
2. Drain water from filter into sink, and dispose in normal household trash.
3. Wipe up excess water in filter cover and continue with *Initial Installation*, steps 2 through 3.

The filter should be changed at least every 12 months.

**Important:** Condition of water and amount used determines life span of water filter cartridge. If water use is high, or if water is of poor quality, replacement may need to take place more often.

To purchase a replacement water filter cartridge, contact your dealer or call 1-877-232-6771 USA or 1-800-688-8408 Canada.

The dispenser feature may be used without a water filter cartridge. If you choose this option, replace filter with blue bypass cap.

State of California  
Department of Health Services

### Water Treatment Device Certificate Number

03 - 1583

Date Issued: September 16, 2003  
Date Revised: April 22, 2004

Trademark/Model Designation	Replacement Elements
-----------------------------	----------------------

UKF8001AXX750	UKF8001AXX
469006-750	46 9006
67003523-750	67003523

**Manufacturer:** PentaPure Inc.

The water treatment device(s) listed on this certificate have met the testing requirements pursuant to Section 116830 of the Health and Safety Code for the following health related contaminant's:

**Microbiological contaminant's and Turbidity**

Cysts  
Turbidity

**Inorganic/Radiological contaminant's**

Asbestos  
Lead  
Mercury

**Organic contaminant's**

Atrazine  
Lindane  
Benzene  
Carbofuran  
p-dichlorobenzene  
Toxaphene

**Rated Service Capacity:** 750 gal.

**Rated Service Flow:** 0.78 gpm

**Conditions of Certification:**

**Do not** use where water is microbiologically unsafe or with water of unknown quality, except that systems certified for cyst reduction may be used on disinfected waters that may contain filterable cysts.



# PuriClean II System Specification and Performance Data Sheet

## Refrigerator Water Filter Cartridge Model UKF8001AXX

### Specifications

Service Flow Rate (Maximum).....0.78 GPM (2.9 L/min)  
 Rated Service Life UKF8001AXX-750 (Maximum).....750 gallons/2838 liters  
 Maximum Operating Temperature .....100° F / 38° C  
 Minimum Pressure Requirement.....35 psi / 241 kPa  
 Minimum Operating Temperature.....33° F / 1° C  
 Maximum Operating Pressure.....120 psi / 827 kPa



1000 Apollo Road  
 Eagan, Minnesota 55121-2240  
 651.450.4913  
 EPA EST #35917-MN-1

100834/B

### Performance Data

Standard No. 42: Aesthetic Effects								
Parameter	USEPA MCL	Influent Challenge Concentration	Influent Average	Effluent		% Reduction		Min. Required Reduction
				Average	Maximum	Average	Minimum	
Chlorine	—	2.0 mg/L ± 10%	1.88 mg/L	<0.05136364 mg/L	0.06 mg/L	>97.26%	96.84%	50%
T & O	—	—	—	—	—	—	—	—
Particulate**	—	at least 10,000 particles/ml	5,700,000 #/ml	30,583 #/ml	69,000 #/ml	99.52%	98.94%	85%

Standard No. 53: Health Effects								
Parameter	USEPA MCL	Influent Challenge Concentration	Influent Average	Effluent		% Reduction		Min. Required Reduction
				Average	Maximum	Average	Minimum	
Turbidity	1 NTU**	11 ± 1 NTU***	10.7 NTU	0.31 NTU	.049 NTU	97.09%	95.20%	0.5 NTU
Cysts	99.5% Reduction	Minimum 50,000/L	166,500 #/L	<1 #/L	<1 #/L	>99.99%	>99.99%	>99.95%
Asbestos	99% Reduction	10' 10 <sup>6</sup> fibers/L; fibers >10 micrometers in length	155 MF/L	<1 MF/L	<1 MF/L	>99.99%	>99.99%	99%
Lead at pH 6.5	0.015 mg/L	0.15 mg/L + 10%	0.153 mg/L	<.001 mg/L	<.001 mg/L	>99.35%	>99.29%	0.10 mg/L
Lead at pH 8.5	0.015 mg/L	0.15 mg/L + 10%	0.150 mg/L	<.001 mg/L	<.001 mg/L	>99.33%	>99.29%	0.10 mg/L
Mercury at pH 6.5	0.002 mg/L	.006 mg/L ± 10%	0.006 mg/L	0.0003 mg/L	0.0005 mg/L	95.70%	90.91%	0.002 mg/L
Mercury at pH 8.5	0.002 mg/L	.006 mg/L ± 10%	0.006 mg/L	0.0008 mg/L	0.0015 mg/L	86.22%	75.93%	0.002 mg/L
Atrazine	0.003 mg/L	0.009 mg/L + 10%	0.009 mg/L	<0.002 mg/L	0.002 mg/L	76.99%	75.31%	0.003 mg/L
Benzene	0.005 mg/L	0.015 mg/L ± 10%	0.014 mg/L	0.0006 mg/L	0.0011 mg/L	95.71%	92.14%	0.005 mg/L
Carbofuran	0.04 mg/L	0.08 mg/L ± 10%	0.081 mg/L	<0.001 mg/L	<0.001 mg/L	98.74%	98.46%	0.04 mg/L
p-Dichlorobenzene	0.075 mg/L	.225 mg/L ± 10%	0.208 mg/L	<0.0005 mg/L	<0.0005 mg/L	99.76%	99.74%	0.075 mg/L
Lindane	0.0002 mg/L	0.002 mg/L + 10%	0.002 mg/L	0.000 mg/L	<0.0001 mg/L	98.72%	96.50%	0.0002 mg/L
Toxaphene	0.003 mg/L	0.015 ± 10%	0.015 mg/L	<0.001 mg/L	<0.001 mg/L	92.97%	91.67%	0.003 mg/L

\* Tested using a flow rate of 0.78 gpm; pressure of 60 psig; pH of 7.5 + 0.5; temp. of 68° + 5° F (20° + 3° C)

\*\* Measurement in Particles/ml. Particles used were 0.5 - 1 microns

\*\*\* NTU - Nephelometric Turbidity Units

### General Use Conditions

Read this Performance Data Sheet and compare the capabilities of this unit with your actual water treatment needs.

**DO NOT use this product where water is microbiologically unsafe or of unknown quality without adequate disinfection before or after the system. System certified for cyst reduction may be used on disinfected water that may contain filterable cysts.**

**USE ONLY WITH COLD WATER SUPPLY. CHECK FOR COMPLIANCE WITH THE STATE AND LOCAL LAWS AND REGULATIONS.**



Tested and certified by NSF International against ANSI/NSF Standards 42 & 53 in models UKF8001AXX-750 for the reduction of:

**Standard No. 42: Aesthetic Effects**

Taste and Odor Reduction  
 Chlorine Taste & Odor  
 Mechanical Filtration Unit  
 Particulate Reduction Class 1

**Standard No. 53: Health Effects**

Chemical Reduction Unit  
 Lead, Atrazine, Lindane, Benzene,  
 Carbofuran, p-Dichlorobenzene, Mercury  
 & Toxaphene Reduction  
 Mechanical Filtration Unit  
 Cyst, Turbidity and Asbestos Reduction

The PuriClean® II retractable water filtration system uses a UKF8001AXX replacement cartridge. Timely replacement of filter cartridge is essential for performance satisfaction from this filtration system. Please refer to the applicable section of your Use and Care Guide for general operation, maintenance requirements and troubleshooting. Suggested retail price of replacement water filter is \$39.99.

This system has been tested according to ANSI/NSF 42 and 53 for reduction of the substance listed above. The concentration of the indicated substances in water entering the system was reduced to a concentration less than or equal to the permissible limit for water leaving the system, as specified in ANSI/NSF 42 and 53.





# Fresh Food Features

## Shelves

### ⚠ CAUTION

To avoid personal injury or property damage, observe the following:

- **Never** attempt to adjust a shelf that is loaded with food.
- Confirm shelf is secure *before* placing items on shelf.
- Handle tempered glass shelves carefully. Shelves may break suddenly if nicked, scratched, or exposed to sudden temperature change.

## Spillsaver™ Glass Shelves

Your refrigerator has Spillsaver™ glass shelves. The shelves have a spill retainer edge which allows for easier clean up and some are equipped with a slide out feature. To slide out, grasp the front of the shelf and pull forward. Push in the shelf to return to the original position.

### To Remove a Shelf:

- Slightly tilt up the front and lift up the rear of the shelf, then pull the shelf straight out.

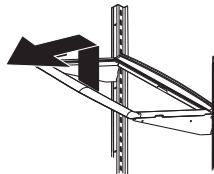

### To Lock the Shelf Into Another Position:

- Tilt up the front edge of the shelf.
- Insert the hook into the desired frame openings and let the shelf settle into place.
- Be sure the shelf is securely locked at the rear.

## Crisper Top

The crisper top serves as the lower fresh food shelf.

### To Remove the Crisper Top:

- Remove crisper drawers.
- Place hand under the frame to push up the glass. Lift glass out.
- Lift frame from refrigerator liner rails.

### To Install:

- Replace frame in refrigerator liner rails.
- Carefully replace glass into frame.

## Door Storage

### Dairy Center

The dairy center provides convenient door storage for spreadable items such as butter and margarine. This compartment can be moved to different locations to accommodate storage needs. To use the dairy center, raise the cover.

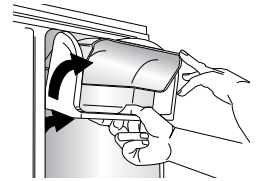

### To Remove:

- Raise the cover, push upward and pull out.

### To Install:

- Slide the dairy center in and push down until firmly seated in the door liner.

### Door Buckets

Door buckets can be moved to meet storage needs.

### To Remove:

- Slide bucket up and pull straight out.

### To Install:

- Slide bucket in and push down until firmly seated in the door liner.

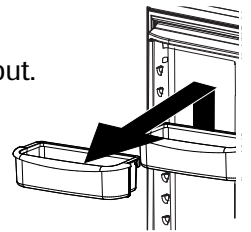

## Crisper Drawers

The crisper drawers provide a higher humidity environment for fresh fruit and vegetable storage.

### Controls

The crisper controls regulate the amount of humidity in the crisper drawer. Slide the control toward the **FRUIT** setting for produce with outer skins. Slide the control toward the **VEGETABLES** setting for leafy produce.

VEGETABLES

FRUIT

HUMIDITY CONTROLLED

### To Remove:

- Pull drawer out to full extension. Tilt up front of drawer and pull straight out.

### To Install:

- Insert drawer into frame rails and push back into place.

**Note:** For best results, keep the crisper drawers tightly closed.



# Fresh Food Features

## Chef's Pantry™ Drawer

The Chef's Pantry™ drawer is a full-width drawer with adjustable temperature control. This drawer can be used for large party trays, deli items, beverages or miscellaneous items and features a divider to organize the drawer into sections if desired.

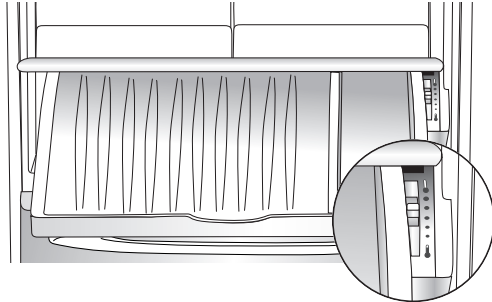

There is a temperature control which adjusts the amount of cold air allowed into the drawer. The control is located on the right side of the drawer, under the lid.

Set the control to the **higher setting** to provide a normal refrigerator temperature. Set the drawer on the **lower setting** when a temperature colder than the main refrigerator compartment is desired. Use the coldest setting when storing meats.

### Notes:

- Cold air directed to the drawer can decrease refrigerator temperature. Refrigerator control may need to be adjusted.
- **Do not** place leafy vegetables in the drawer. Colder temperatures could damage leafy produce.

### To Remove Drawer:

- Lift lid. Pull drawer out to full extension. Tilt up front of drawer and pull straight out.

### To Install Drawer:

- Push metal glide rails to the back of the refrigerator. Place drawer onto rails and slide drawer back until it falls into place.

### To Remove Divider:

- Pull drawer completely out and raise the front of the divider to unhook it from the rear wall of the drawer, then lift drawer out.

### To Install Divider:

- Hook back of divider over rear wall of drawer and lower into place.

## Accessories

### Grip Pads (select models)

The grip pads prevent objects from sliding in the door buckets. Grip pads are removable and are top-rack dishwasher safe for easy cleaning.

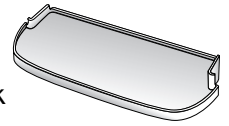

### Egg Tray (style may vary)

The egg tray holds a "dozen-plus" eggs. It can be removed to carry to a work area or to be washed.

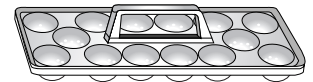

### Wine Trivet/Can Rack

The wine trivet/can rack accessory fits in the Chef's Pantry™ drawer or on a shelf.

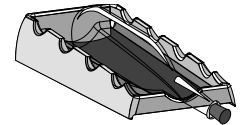

Bottles or cans can be laid crosswise, or a single bottle may be laid in the center depression.

### FastGrab™ Organizer

The vertical can rack is located in the fresh food section on the inside left door. The can rack is designed to hold six - 12oz. cans, 20oz. bottles, baby bottles or yogurt containers individually.

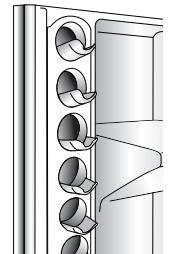

### Beverage Chiller

The Beverage Chiller keeps beverages and other items cooler than the rest of the fresh food section. A cold air inlet allows air from the freezer section to pass into the Beverage Chiller. The Beverage Chiller control is located on the right wall of the fresh food compartment. The control adjusts the amount of cold air allowed into the Beverage Chiller. For a cooler temperature in the Beverage Chiller, slide the control down. The Beverage Chiller can hold up to two gallons of milk or two-2 liter bottles of soda, for example.

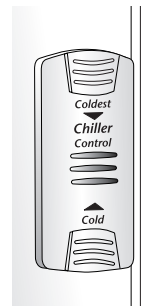

### To Remove:

- Slide bucket up and straight out. Firmly hold each side of the beverage chiller, lift up and away from the door.

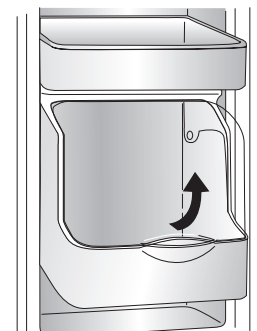

### To Install:

- Reverse above procedure.



# Freezer Features

## Freezer Bin

### To Remove:

- Pull upper drawer out to full extension and lift out to remove.

### To Install:

- Slide upper drawer into freezer. Make sure the large square holes along outer bin align with square knobs on freezer drawer.

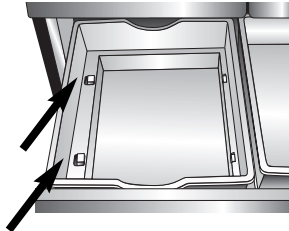

## Lower Freezer Drawer

**Note:** See pages 6-7 for complete information on lower drawer and drawer removal.



# Food Storage Tips

## Fresh Food Storage

- The fresh food compartment of a refrigerator should be kept between 34°-40° F (1°-4° C) with an optimum temperature of 37° F (3° C). To check the temperature, place an appliance thermometer in a glass of water and place in the center of the refrigerator. Check after 24 hours. If the temperature is above 40° F (4° C) adjust the controls as explained on pages 10 and 11.
- Avoid overcrowding the refrigerator shelves. This reduces the circulation of air around the food and results in uneven cooling.

## Fruits and Vegetables

- Storage in the crisper drawers traps humidity to help preserve the fruit and vegetable quality for longer time periods (see page 16).
- Sort fruits and vegetables *before* storage and use bruised or soft items first. Discard those showing signs of decay.
- Always wrap odorous foods such as onions and cabbage so the odor does not transfer to other foods.
- While vegetables need a certain amount of humidity to remain fresh, too much humidity can shorten storage times (especially leafy vegetables). Drain vegetables well *before* storing.
- Wait to wash fresh produce until right before use.

## Meat and Cheese

- Storage in Chef's Pantry™ drawer helps preserve quality for longer time periods.
- Raw meat and poultry should be wrapped securely so leakage and contamination of other foods or surfaces does not occur.
- Occasionally mold will develop on the surface of hard cheeses (Swiss, Cheddar, Parmesan). Cut off at least an inch around and below the moldy area. Keep your knife or instrument out of the mold itself.  
**Do not** try to save individual cheese slices, soft cheese, cottage cheese, cream, sour cream or yogurt when mold appears.

## Dairy Food

- For milk and cream, store in the Beverage Chiller which is designed to maintain a lower temperature for optimum freshness and life.

- Most dairy foods such as milk, yogurt, sour cream and cottage cheese have freshness dates on their cartons for appropriate length of storage. Store these foods in the original carton and refrigerate immediately after purchasing and after each use.

## Frozen Food Storage

- The freezer compartment of a refrigerator should be kept at approximately 0° F (-18° C). To check the temperature, place an appliance thermometer between the frozen packages and check after 24 hours. If the temperature is above 0° F (-18° C), adjust the control as described on page 10.
- A freezer operates more efficiently when it is at least two-thirds full.

## Packaging Foods for Freezing

- To minimize dehydration and quality deterioration use aluminum foil, freezer wrap, freezer bags or airtight containers. Force as much air out of the packages as possible and be sure they are tightly sealed. Trapped air can cause the food to dry out, change color and develop an off-flavor (freezer burn).
- Overwrap fresh meats and poultry with suitable freezer wrap prior to freezing.
- **Do not** refreeze meat that has completely thawed.

## Loading the Freezer

- Avoid adding too much warm food to the Freezer at one time. This overloads the Freezer, slows the rate of freezing and can raise the temperature of frozen foods.
- Leave space between the packages so cold air can circulate freely, allowing food to freeze as quickly as possible.

Refer to the *Food Storage Chart* on pages 20 and 21 for approximate storage times.



# Food Storage Tips

## Food Storage Chart

Storage times are approximate and may vary depending on type of packaging, storage temperature, and the quality of the food when purchased.

FOODS	REFRIGERATOR	FREEZER	STORAGE TIPS
<b>DAIRY PRODUCTS</b>			
Butter	1 month	6 to 9 months	Wrap tightly or cover.
Milk and cream	1 week <i>Store in Temperature Controlled Beverage Chiller.</i>	Not recommended	Check carton date. Close tightly. <b>Do not</b> return unused portions to original container. <b>Do not</b> freeze cream unless whipped.
Cream cheese, cheese spread and cheese food	1 to 2 weeks	Not recommended	Wrap tightly.
Cottage cheese	3 to 5 days	Not recommended	Store in original carton. Check carton date.
Sour cream	10 days	Not recommended	Store in original carton. Check carton date.
Hard cheese (Swiss, Cheddar and Parmesan)	1 to 2 months	4 to 6 months May become crumbly	Wrap tightly. Cut off any mold.
<b>EGGS</b>			
Eggs in the shell	3 weeks	Not recommended	Refrigerate small ends down.
Leftover yolks or whites	2 to 4 days	9 to 12 months	For each cup of yolks to be frozen, add 1 tsp. sugar for use in sweet, or 1 tsp. salt for non-sweet dishes.
<b>FRUITS</b> <i>Store in Crisper Drawer</i>			
Apples	1 month	8 months (cooked)	May also store unripe or hard apples at 60° to 70° F (16° to 21° C).
Bananas	2 to 4 days	6 months (whole/peeled)	Ripen at room temperature <i>before</i> refrigerating. <b>Note:</b> Bananas darken when refrigerated.
Pears, plums, avocados	3 to 4 days	Not recommended	Ripen at room temperature <i>before</i> refrigerating. <b>Note:</b> Avocados darken when refrigerated.
Berries, cherries, apricots	2 to 3 days	6 months	Ripen at room temperature <i>before</i> refrigerating.
Grapes	3 to 5 days	1 month (whole)	Ripen at room temperature <i>before</i> refrigerating.
Citrus fruits	1 to 2 weeks	Not recommended	May also store at 60° to 70° F (16° to 21° C). If refrigerated, store uncovered.
Pineapples, cut	2 to 3 days	6 to 12 months	Will not ripen after purchase. Use quickly.



# Food Storage Tips

FOODS	REFRIGERATOR	FREEZER	STORAGE TIPS
<b>VEGETABLES</b> <i>Store in Crisper Drawer</i>			
Asparagus	1 to 2 days	8 to 10 months	<b>Do not</b> wash <i>before</i> refrigerating. Store in crisper.
Brussels sprouts, broccoli, cauliflower, green peas, lima beans, onions, peppers	3 to 5 days	8 to 10 months	Wrap odorous foods. Leave peas in pods.
Cabbage, celery	1 to 2 weeks	Not recommended	Wrap odorous foods and refrigerate in crisper.
Carrots, parsnips, beets and turnips	7 to 10 days	8 to 10 months	Remove tops. Wrap odorous foods and refrigerate in the crisper.
Lettuce	7 to 10 days	Not recommended	
<b>POULTRY and FISH</b> <i>Store in Chef's Pantry™ Drawer or Freezer</i>			
Chicken and Turkey, whole	1 to 2 days	12 months	Keep in original packaging for refrigeration. Place in the meat and cheese drawer. When freezing longer than two weeks, overwrap with freezer wrap.
Chicken and Turkey, pieces	1 to 2 days	9 months	
Fish	1 to 2 days	2 to 6 months	
<b>MEATS</b> <i>Store in Chef's Pantry™ Drawer or Freezer</i>			
Bacon	7 days	1 month	
Beef or lamb, ground	1 to 2 days	3 to 4 months	Fresh meats can be kept in original packaging for refrigeration.
Beef or lamb, roast and steak	3 to 5 days	6 to 9 months	Place in the meat and cheese drawer. When freezing longer than two weeks, overwrap with freezer wrap.
Ham, fully cooked, whole	7 days	1 to 2 months	
half	5 days	1 to 2 months	
slices	3 days	1 to 2 months	
Luncheon meat	3 to 5 days	1 to 2 months	Unopened, vacuum-packed luncheon meat may be kept up to two weeks in the meat and cheese drawer.
Pork, roast	3 to 5 days	4 to 6 months	
Pork, chops	3 to 5 days	4 months	
Sausage, ground	1 to 2 days	1 to 2 months	
Sausage, smoked	7 days	1 to 2 months	
Veal	3 to 5 days	4 to 6 months	
Frankfurters	7 days	1 month	Processed meats should be tightly wrapped and stored in the meat and cheese drawer.

Sources: United States Department of Agriculture; Food Marketing Institute; Cooperative Extension Service, Iowa State University



# Care and Cleaning

## ⚠ WARNING

To avoid electrical shock which can cause severe personal injury or death, disconnect power to refrigerator *before* cleaning. After cleaning, connect power.

## ⚠ CAUTION

**To avoid personal injury or property damage, observe the following:**

- Read and follow manufacturer's directions for all cleaning products.
- **Do not** place buckets, shelves or accessories in dishwasher. Cracking or warping of accessories may result.

## Refrigerator Cleaning Chart

PART	DO NOT USE	DO
<b>Smooth or Textured Painted Doors and Exterior (select models)</b> <i>Damage to finish due to improper use of cleaning products or non-recommended products is <b>not</b> covered under this product's warranty.</i>	Abrasive or harsh cleaners Ammonia Chlorine bleach Concentrated detergents or solvents Metal or plastic-textured scouring pads	Use 4 tablespoons of baking soda dissolved in 1 quart (1 liter) warm, soapy water. Rinse surfaces with clean, warm water and dry immediately to avoid water spots.
<b>Cabinet Interior</b>		
<b>Stainless Steel Doors and Exterior (select models)</b> <b>Important:</b> <i>Damage to stainless steel finish due to improper use of cleaning products or non-recommended products is <b>not</b> covered under this product's warranty.</i>	Abrasive or harsh cleaners Ammonia Chlorine bleach Concentrated detergents or solvents Metal or plastic-textured scouring pads Vinegar-based products Citrus-based cleaners	Use warm, soapy water and a soft, clean cloth or sponge. Rinse surfaces with clean, warm water and dry immediately to avoid water spots. To polish and help prevent fingerprints, follow with Stainless Steel Magic Spray (part no. 20000008*).
<b>Door Gaskets and Ice Dispenser Chute</b>	Abrasive or harsh cleaners Metal or plastic-textured scouring pads	Use warm, soapy water and a soft, clean cloth or sponge.
<b>Condenser Coil</b> <i>Remove base grille to access.</i>	Anything other than a vacuum cleaner	Use a vacuum cleaner hose nozzle.
<b>Condenser Fan Outlet Grille</b> <i>See back of refrigerator.</i>		Use a vacuum cleaner hose nozzle with brush attachment.
<b>Accessories</b> <i>Shelves, buckets, drawers, etc.</i>	A dishwasher	Follow removal and installation instructions from appropriate feature section. <b>Allow items to adjust to room temperature.</b> Dilute mild detergent and use a soft, clean cloth or sponge for cleaning. Use a plastic bristle brush to get into crevices. Rinse surfaces with clean, warm water. Dry glass and clear items immediately to avoid spots.

\* To order, call 1-877-232-6771 USA or 1-800-688-8408 Canada.



# Care and Cleaning

## Removing Odors from Refrigerator

### ⚠ WARNING

To avoid electrical shock which can cause severe personal injury or death, disconnect power to refrigerator *before* cleaning. After cleaning, reconnect power.

1. Remove all food and turn the refrigerator off.
2. Disconnect power to the refrigerator.
3. Clean the walls, floor, ceiling of cabinet interior, drawers, shelves and gaskets according to the instructions on page 22.
4. Dilute mild detergent and brush solution into crevices using a plastic bristle brush. Let stand for 5 minutes. Rinse surfaces with warm water. Dry surfaces with a soft, clean cloth.
5. Wash and dry all bottles, containers and jars. Discard spoiled or expired items.
6. Wrap or store odor-causing foods in tightly sealed containers to prevent recurring odors.
7. Reconnect power to refrigerator and return food to refrigerator.
8. Allow the refrigerator to cool.
9. After 24 hours, check if odor has been eliminated.

### If Odor is Still Present:

1. Remove drawers and place on top shelf of refrigerator.
2. Pack refrigerator and freezer sections – including doors – with crumpled sheets of black and white newspaper.
3. Place charcoal briquettes randomly on crumpled newspaper in both freezer and fresh food compartments.
4. Close doors and let stand 24 to 48 hours.

## Energy Saving Tips

- Avoid overcrowding refrigerator shelves. Overcrowding reduces air circulation around food and causes refrigerator to run longer.
- Avoid adding too much warm food to refrigerator at one time. This overloads compartments and slows rate of cooling.
- **Do not** use aluminum foil, wax paper, or paper toweling as shelf liners. This decreases air flow and causes refrigerator to run less efficiently.
- A freezer that is two-thirds full runs most efficiently.
- Locate refrigerator in coolest part of room. Avoid areas of direct sunlight, or near heating ducts, registers or other heat producing appliances. If this is not possible, isolate exterior by using a section of cabinet or an added layer of insulation.
- Clean door gaskets every three months according to cleaning instructions. This will assure that door seals properly and refrigerator runs efficiently.
- Take time to organize items in refrigerator to reduce time that door is open.
- Be sure your doors are closing securely by leveling refrigerator according to the instructions on page 4.
- Clean condenser coils as indicated in the cleaning instructions every three months. This will increase energy efficiency and cooling performance.





# Care and Cleaning

## Replacing Light Bulbs

### ⚠ WARNING

To avoid electrical shock which can cause severe personal injury or death, disconnect power to refrigerator *before* replacing light bulb. After replacing light bulb, reconnect power.

### ⚠ CAUTION

To avoid personal injury or property damage, observe the following:

- Allow light bulb to cool.
- Wear gloves when replacing light bulb.

### Fresh Food Section

The fresh food light bulbs are located at the top of the compartment and beneath the ice storage enclosure. The freezer light bulb is located at the top front of the freezer section.

#### Fresh food section upper front

1. Squeeze both sides of light shield in the open area while pulling downward to remove.

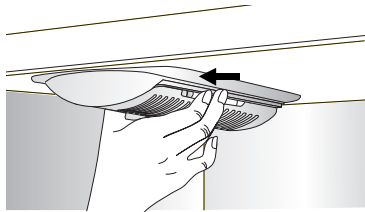

2. Remove light bulbs.

3. Replace with appliance bulbs **no greater than 40-watts.**

4. Replace light bulb cover by inserting tabs on light shield into liner holes on each side of light assembly. **Do not** force shield beyond locking point. Doing so may damage light shield.

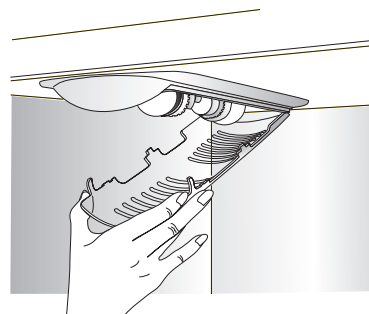

### Fresh food enclosure light

1. Pull cover out, press along upper edge and roll light cover up and forward to remove.

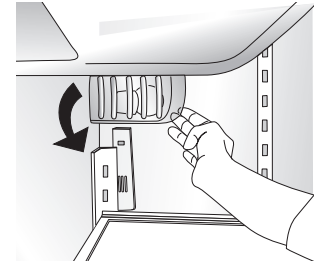

2. Remove light bulb. Replace with appliance bulb **no greater than 40-watts.**

3. Insert lower tabs of light cover into slots of fresh food liner. Roll upward to snap into slots located under the ice storage enclosure.

### Freezer Light

1. Remove light bulb.
2. Replace bulb with appliance bulb **no greater than 40-watts.**

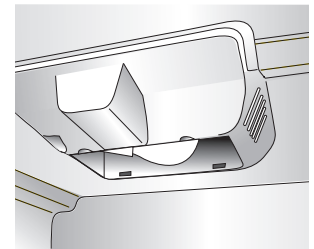



# Care and Cleaning

## Preparing for Vacation

### ⚠ CAUTION

If there is any possibility that the temperature can drop below freezing where the refrigerator is located, the water supply system (including the water tank and the water valve) must be drained by a qualified servicer.

#### For Short Vacations or Absences (Three Months or Less):

1. Remove all perishables.
2. If no one will be checking in on the refrigerator during your absence, remove all frozen items also.
  - Shut off the water supply to the ice maker at least one day ahead of time.
  - After the last load of ice drops, press ice maker switch to **OFF**.
  - Empty the ice bin.
3. If the room temperature will drop below 55° F (13° C), follow the instructions for longer absences.

#### For Long Vacations, Absences (More Than Three Months) OR if the Room Temperature Will Drop Below 55° F (13° C):

1. Remove food.
  - Shut off the water supply to the ice maker at least one day ahead of time.
  - After the last load of ice drops, press ice maker switch to **OFF**.
  - Empty the ice bin.
2. Remove the water filter cartridge and install the filter bypass. Dispose of the used cartridge.
3. Turn the Freezer control to **OFF**.
4. Unplug the refrigerator.
5. Thoroughly clean the interior of both compartments with a baking soda solution and a clean, soft cloth (four tablespoons of baking soda in one quart of warm water).
6. Dry thoroughly.
7. Secure both doors open to prevent odors and to keep the doors from shutting while you are away.

## Upon your Return

#### After a Short Vacation or Absence:

- Reconnect the water supply and turn on supply valve (see pages 8-9).
- Monitor water connection for 24 hours and correct leaks if necessary.
- Run 10-15 glasses of water from the dispenser to flush out the system.
- Restart the ice maker, by pressing switch to the **ON** position.
- Discard at least the first three ice harvests.

#### After a Long Vacation or Absence:

- Reconnect the water supply and turn on supply valve (see pages 8-9).
- Plug the refrigerator back in and reset controls (see page 10-11).
- Monitor water connection for 24 hours and correct leaks, if necessary.

Run water through the dispenser for at least three minutes with the filter bypass in place, then install water filter (see page 14).

- After installing the water filter, run water through the dispenser continuously for at least two minutes, or until water runs steady. Initially you may notice a one to two minute delay in water dispersal as the internal tanks fills.
- Restart the ice maker by, pressing switch to the **ON** position.
- Discard ice produced within the first 12 hours (at least the first three harvests).

## Preparing to Move

- Follow the above instructions for long vacations/absences, through step 7.
- Secure all loose items such as shelves and drawers by taping them securely in place to prevent damage.
- Tape the doors shut.
- Use an appliance dolly when moving the refrigerator. **ALWAYS** truck the refrigerator from its side or back - **NEVER** from its front.
- Be sure the refrigerator stays in an upright position during moving.

# Operating Sounds

Improvements in refrigeration design may produce sounds in your new refrigerator that are different or were not present in an older model. These improvements were made to create a refrigerator that is better at preserving food, is more energy efficient, and is quieter overall. Because new refrigerators run quieter, sounds may be detected that were present in older refrigerators, but were masked by higher sound levels. Many of these sounds are normal. Please note that the surfaces adjacent to a refrigerator, such as hard walls, floors and cabinetry may make these sounds seem even louder. The following are some of the normal sounds that may be noticed in a new refrigerator.

SOUND	POSSIBLE CAUSES	SOLUTION
<b>Clicking</b>	• Freezer control <b>(A)</b> clicks when starting or stopping compressor.	• Normal operation
	• Defrost timer or electric damper control (select models) <b>(B)</b> sounds like an electric clock and snaps in and out of defrost cycle.	• Normal operation
<b>Air rushing or whirring</b>	• Condenser fan <b>(D)</b> makes this noise while operating.	• Normal operation
	• Freezer fan <b>(C)</b> makes this noise while operating.	• Normal operation
	• Freezer fan <b>(C)</b> slows to a stop as the freezer door is opened.	• Normal operation
<b>Gurgling or boiling sound</b>	• Evaporator <b>(E)</b> and heat exchanger <b>(F)</b> refrigerant make this noise when flowing.	• Normal operation
<b>Thumping</b>	• Ice cubes from ice maker drop into ice bucket <b>(G)</b> .	• Normal operation
	• Dispenser ice chute <b>(H)</b> closing.	• Normal operation
<b>Vibrating noise</b>	• Compressor <b>(I)</b> makes a pulsating sound while running.	• Normal operation
	• Refrigerator is not level.	• See <i>Leveling</i> , page 4.
<b>Buzzing</b>	• Ice maker water valve <b>(J)</b> hookup buzzes when ice maker fills with water.	• Normal operation
<b>Humming</b>	• Ice maker <b>(K)</b> is in the 'on' position without water connection.	• Normal operation
	• Ice auger <b>(L)</b> hums as auger agitates ice during dispensing.	• Stop sound by turning ice maker switch to <b>OFF</b> . See <i>Automatic Ice Maker</i> , page 12 for details.
	• Compressor <b>(I)</b> can make a high pitched hum while operating.	• Normal operation
	• Solenoid valve <b>(M)</b> operating ice chute door.	• Normal operation
<b>Beeping</b>	• Doors are open, or have not been properly closed.	• See <i>Opening and Closing your Fresh Food Doors</i> , page 9.
	• Door Alarm, Temp Alarm.	• See page 11 for <i>Door Alarm and Temp Alarm</i> .

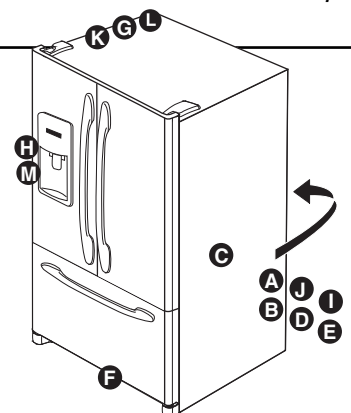

# Troubleshooting

PROBLEM	POSSIBLE CAUSES	WHAT TO DO
<b>Freezer control and lights are on, but compressor is not operating</b>	<ul style="list-style-type: none"> <li>Refrigerator is in defrost mode.</li> </ul>	<ul style="list-style-type: none"> <li>Normal operation. Wait 40 minutes to see if refrigerator restarts.</li> </ul>
<b>Temperature-controlled drawers are too warm</b>	<ul style="list-style-type: none"> <li>Control settings are too low.</li> </ul>	<ul style="list-style-type: none"> <li>See pages 10 and 11 to adjust controls.</li> </ul>
	<ul style="list-style-type: none"> <li>Freezer controls are set too low.</li> </ul>	<ul style="list-style-type: none"> <li>See pages 10 and 11 to adjust controls.</li> </ul>
	<ul style="list-style-type: none"> <li>Drawer is improperly positioned.</li> </ul>	<ul style="list-style-type: none"> <li>See page 16 to verify drawer positioning.</li> </ul>
<b>Refrigerator does not operate</b>	<ul style="list-style-type: none"> <li>Refrigerator is not plugged in.</li> </ul>	<ul style="list-style-type: none"> <li>Plug in refrigerator.</li> </ul>
	<ul style="list-style-type: none"> <li>Touch temperature controls are set to "OFF".</li> </ul>	<ul style="list-style-type: none"> <li>See pages 10 and 11 to adjust controls.</li> </ul>
	<ul style="list-style-type: none"> <li>Fuse is blown, or circuit breaker needs to be reset.</li> </ul>	<ul style="list-style-type: none"> <li>Replace any blown fuses. Check circuit breaker and reset, if necessary.</li> </ul>
	<ul style="list-style-type: none"> <li>Power outage has occurred.</li> </ul>	<ul style="list-style-type: none"> <li>Call local power company listing to report outage.</li> </ul>
<b>Refrigerator still won't operate</b>	<ul style="list-style-type: none"> <li>Refrigerator is malfunctioning.</li> </ul>	<ul style="list-style-type: none"> <li>Unplug refrigerator and transfer food to another refrigerator. If another refrigerator is not available, place dry ice in freezer section to preserve food. Warranty does not cover food loss. Contact service for assistance.</li> </ul>
<b>Food temperature is too cold</b>	<ul style="list-style-type: none"> <li>Condenser coils are dirty.</li> </ul>	<ul style="list-style-type: none"> <li>Clean according to the chart on page 22.</li> </ul>
	<ul style="list-style-type: none"> <li>Refrigerator or freezer controls are set too cold.</li> </ul>	<ul style="list-style-type: none"> <li>See pages 10 and 11 to adjust controls.</li> </ul>
	<ul style="list-style-type: none"> <li>Food is too close to upper left air inlet.</li> </ul>	<ul style="list-style-type: none"> <li>Relocate food.</li> </ul>
	<ul style="list-style-type: none"> <li>Ice bin not locked in place.</li> </ul>	<ul style="list-style-type: none"> <li>See pages 12 and 13 to verify correct installation of ice storage bin.</li> </ul>
<b>Food temperature is too warm</b>	<ul style="list-style-type: none"> <li>Door is not closing properly.</li> </ul>	<ul style="list-style-type: none"> <li>Refrigerator is not level. See page 4 for details on how to level your refrigerator.</li> </ul>
		<ul style="list-style-type: none"> <li>Check gaskets for proper seal. Clean, if necessary, according to the chart on page 22.</li> </ul>
		<ul style="list-style-type: none"> <li>Check for internal obstructions that are keeping door from closing properly (i.e. improperly closed drawers, ice buckets, oversized or improperly stored containers, etc.)</li> </ul>
	<ul style="list-style-type: none"> <li>Controls need to be adjusted.</li> </ul>	<ul style="list-style-type: none"> <li>See pages 10 and 11 to adjust controls.</li> </ul>
	<ul style="list-style-type: none"> <li>Condenser coils are dirty.</li> </ul>	<ul style="list-style-type: none"> <li>Clean according to the chart on page 22.</li> </ul>
	<ul style="list-style-type: none"> <li>Rear air grille is blocked.</li> </ul>	<ul style="list-style-type: none"> <li>Check the positioning of food items in fresh food compartment to make sure grille is not blocked. Rear air grilles are located at the upper left side and under the crisper drawers of the fresh food compartment.</li> </ul>
	<ul style="list-style-type: none"> <li>Door has been opened frequently, or has been opened for long periods of time.</li> </ul>	<ul style="list-style-type: none"> <li>Reduce time door is open. Organize food items efficiently to assure door is open for as short a time as possible.</li> </ul>
	<ul style="list-style-type: none"> <li>Food has recently been added.</li> </ul>	<ul style="list-style-type: none"> <li>Allow time for recently added food to reach refrigerator or freezer temperature or activate <b>Max Cool</b> to accelerate cooling process.</li> </ul>
<b>Refrigerator has an odor</b>	<ul style="list-style-type: none"> <li>Odor producing foods should be covered or wrapped.</li> </ul>	<ul style="list-style-type: none"> <li>Clean according to instructions on page 22.</li> </ul>
	<ul style="list-style-type: none"> <li>The interior needs cleaning.</li> </ul>	
<b>All interior light bulbs are off</b>	<ul style="list-style-type: none"> <li>Refrigerator is not plugged in</li> </ul>	<ul style="list-style-type: none"> <li>Plug in refrigerator.</li> </ul>
	<ul style="list-style-type: none"> <li>Fuse is blown or circuit breaker needs to be reset.</li> </ul>	<ul style="list-style-type: none"> <li>Replace any blown fuses.</li> </ul>
	<ul style="list-style-type: none"> <li>Doors have been open for six continuous minutes.</li> </ul>	<ul style="list-style-type: none"> <li>Check circuit breaker and reset if necessary.</li> <li>Close all three doors for at least one second.</li> </ul>

# Troubleshooting

PROBLEM	POSSIBLE CAUSES	WHAT TO DO
<b>Water droplets form on inside of refrigerator</b>	<ul style="list-style-type: none"> <li>Humidity levels are high or door has been opened frequently.</li> </ul>	<ul style="list-style-type: none"> <li>See pages 10 and 11 to adjust your controls.</li> <li>Reduce time door is open.</li> <li>Organize food items efficiently to assure door is open for as short a time as possible.</li> </ul>
	<ul style="list-style-type: none"> <li>Check gaskets for proper seal.</li> </ul>	<ul style="list-style-type: none"> <li>Clean, if necessary, according to the chart on page 22.</li> </ul>
<b>Refrigerator or ice maker makes unfamiliar sounds or seems too loud</b>	<ul style="list-style-type: none"> <li>Normal operation.</li> </ul>	<ul style="list-style-type: none"> <li>See page 26 for <i>Operating Sounds</i>.</li> </ul>
<b>Crisper drawers do not close freely</b>	<ul style="list-style-type: none"> <li>Contents of drawer or positioning of items in the surrounding compartment could be obstructing drawer.</li> </ul>	<ul style="list-style-type: none"> <li>Reposition food items and containers to avoid interference with the drawers.</li> </ul>
	<ul style="list-style-type: none"> <li>Drawer is not in proper position.</li> </ul>	<ul style="list-style-type: none"> <li>See pages 17-18 to verify drawer positioning.</li> </ul>
	<ul style="list-style-type: none"> <li>Refrigerator is not level.</li> </ul>	<ul style="list-style-type: none"> <li>See page 4 for details on how to level your refrigerator.</li> </ul>
	<ul style="list-style-type: none"> <li>Drawer channels are dirty or need treatment.</li> </ul>	<ul style="list-style-type: none"> <li>Clean drawer channels with warm, soapy water.</li> <li>Rinse and dry thoroughly.</li> <li>Apply a thin layer of petroleum jelly to drawer channels.</li> </ul>
<b>Refrigerator runs too frequently</b>	<ul style="list-style-type: none"> <li>Doors have been opened frequently or for long periods of time.</li> </ul>	<ul style="list-style-type: none"> <li>Reduce time door is open.</li> <li>Organize food items efficiently to assure door is open for as short a time as possible.</li> </ul>
		<ul style="list-style-type: none"> <li>Allow interior environment to adjust for period the door has been opened.</li> </ul>
	<ul style="list-style-type: none"> <li>Humidity or heat in surrounding area is high.</li> </ul>	<ul style="list-style-type: none"> <li>Normal operation.</li> </ul>
	<ul style="list-style-type: none"> <li>Food has recently been added.</li> </ul>	<ul style="list-style-type: none"> <li>Allow time for recently added food to reach refrigerator or freezer temperature.</li> </ul>
	<ul style="list-style-type: none"> <li>Refrigerator is exposed to heat by environment or by appliances nearby.</li> </ul>	<ul style="list-style-type: none"> <li>Evaluate your refrigerator's environment. Refrigerator may need to be moved to run more efficiently.</li> </ul>
	<ul style="list-style-type: none"> <li>Condenser coils are dirty.</li> </ul>	<ul style="list-style-type: none"> <li>Clean according to the chart on page 22.</li> </ul>
	<ul style="list-style-type: none"> <li>Controls need to be adjusted.</li> </ul>	<ul style="list-style-type: none"> <li>See pages 10 and 11 to adjust your controls.</li> </ul>
	<ul style="list-style-type: none"> <li>Door is not closing properly.</li> </ul>	<ul style="list-style-type: none"> <li>Refrigerator is not level. See page 4 for details on how to level your refrigerator.</li> </ul>
		<ul style="list-style-type: none"> <li>Check gaskets for proper seal.</li> </ul>
		<ul style="list-style-type: none"> <li>Clean, if necessary, according to the chart on page 22.</li> </ul>
	<ul style="list-style-type: none"> <li>Check for internal obstructions that are keeping door from closing properly (i.e. improperly closed drawers, storage bins, oversized or improperly stored containers, etc.)</li> </ul>	
<ul style="list-style-type: none"> <li>Normal operation</li> </ul>	<ul style="list-style-type: none"> <li>See <i>Operating Sounds</i> on page 26.</li> </ul>	



# Troubleshooting

## Ice and Water

PROBLEM	POSSIBLE CAUSES	WHAT TO DO
<b>Refrigerator is leaking water</b>	<ul style="list-style-type: none"> <li>Plastic tubing was used to complete water connection.</li> </ul>	<ul style="list-style-type: none"> <li>The manufacturer recommends using copper tubing for installation. Plastic is less durable and can cause leakage. <b>The manufacturer is not responsible for property damage due to improper installation or water connection.</b></li> </ul>
	<ul style="list-style-type: none"> <li>Improper water valve was installed.</li> </ul>	<ul style="list-style-type: none"> <li>Check water connection procedure (see pages 8-9). Self-piercing and 3/16" saddle valves cause low water pressure and may clog the line over time. <b>The manufacturer is not responsible for property damage due to improper installation or water connection.</b></li> </ul>
<b>Water flow is slower than normal</b>	<ul style="list-style-type: none"> <li>Water pressure is low.</li> </ul>	<ul style="list-style-type: none"> <li>Water pressure must be between 35 to 100 pounds per square inch to function properly. A minimum pressure of 35 pounds per square inch is recommended for refrigerators with water filters.</li> </ul>
	<ul style="list-style-type: none"> <li>Improper water valve was installed.</li> </ul>	<ul style="list-style-type: none"> <li>Check water connection procedure in your Installation Instructions. Self-piercing and 3/16" saddle valves cause low water pressure and may clog the line over time. <b>The manufacturer is not responsible for property damage due to improper installation or water connection.</b> Open water valve completely and check for leaks.</li> </ul>
	<ul style="list-style-type: none"> <li>Copper tubing has kinks.</li> </ul>	<ul style="list-style-type: none"> <li>Turn off water supply and remove kinks. If kinks cannot be removed, replace tubing.</li> </ul>
	<ul style="list-style-type: none"> <li>Water filter is clogged or needs to be changed.</li> </ul>	<ul style="list-style-type: none"> <li>Change water filter (see page 14).</li> </ul>
<b>Ice storage bin will not close</b>	<ul style="list-style-type: none"> <li>Ice cube blockage</li> </ul>	<ul style="list-style-type: none"> <li>Remove spilled ice cube(s) <i>before</i> replacing ice storage bin.</li> </ul>
<b>Water filter indicator light is red</b>	<ul style="list-style-type: none"> <li>Water filter needs to be replaced.</li> </ul>	<ul style="list-style-type: none"> <li>If filter is not available, replace with bypass filter. See <i>Water Filter</i>, pages 14-15.</li> </ul>
	<ul style="list-style-type: none"> <li>Filter indicator sensor needs to be reset.</li> </ul>	<ul style="list-style-type: none"> <li>See <i>Filter Status Indicator Light</i>, page 10.</li> </ul>
<b>Ice forms in inlet tube to ice maker</b>	<ul style="list-style-type: none"> <li>Water pressure is too low</li> </ul>	<ul style="list-style-type: none"> <li>Water pressure must be between 35 to 100 pounds per square inch to function properly. A minimum pressure of 35 pounds per square inch is recommended for refrigerators with water filters.</li> </ul>
	<ul style="list-style-type: none"> <li>Saddle valve not open completely.</li> </ul>	<ul style="list-style-type: none"> <li>Open saddle valve completely.</li> </ul>
	<ul style="list-style-type: none"> <li>Freezer temperature is too high.</li> </ul>	<ul style="list-style-type: none"> <li>See <i>Temperature Controls</i>, pages 10 and 11. Freezer temperature should be between 0° to 2° F (-18° to -17° C) to produce ice.</li> </ul>



# Troubleshooting

PROBLEM	POSSIBLE CAUSES	WHAT TO DO
<b>Ice maker is not producing ice</b>	• Ice maker switch is not ON	• Confirm ice maker switch is ON. See <i>Automatic Ice Maker</i> , pages 12-13.
	• Household water supply is not reaching water valve.	• See <i>Connecting the Water Supply</i> , pages 8-9.
	• Copper tubing has kinks.	• Turn off water supply and remove kinks. If kinks cannot be removed, replace tubing.
	• Water pressure is too low.	• Water pressure must be between 35 to 100 pounds per square inch to function properly. A minimum pressure of 35 pounds per square inch is recommended for refrigerators with water filters.
	• Check freezer temperature.	• See <i>Temperature Controls</i> , pages 10 and 11. Freezer temperature should be between 0° to 2° F (-18° to -17° C) to produce ice.
	• Inner fountain door is blocked or frozen.	• <b>Do not</b> attempt to free the fountain door by continuously pressing the dispenser button. Contact qualified service technician.
<b>Temp Alarm Light is flashing</b>	• Exceeded normal operating temperatures.	• See <i>Temp Alarm</i> , page 11.
<b>All lights on dispenser and interior lights are off and appliance is still running</b>	• Control has been set to Sabbath Mode.	• See, <i>Sabbath Mode</i> , page 11.
<b>Door alarm set, no alarm sounded</b>	• Alarm mode has been disabled.	• To activate audible alarms, refer to page 11.
<b>Temperatures in display look too low</b>	• Temperature display has been set to Celsius rather than Fahrenheit.	• See <i>Temperature</i> display on page 10.