

GE Appliances

# Technical Service Guide

August 2010

## Profile 29 cu. ft. Bottom Freezer

PFSS9PKY  
PFSS9SKY

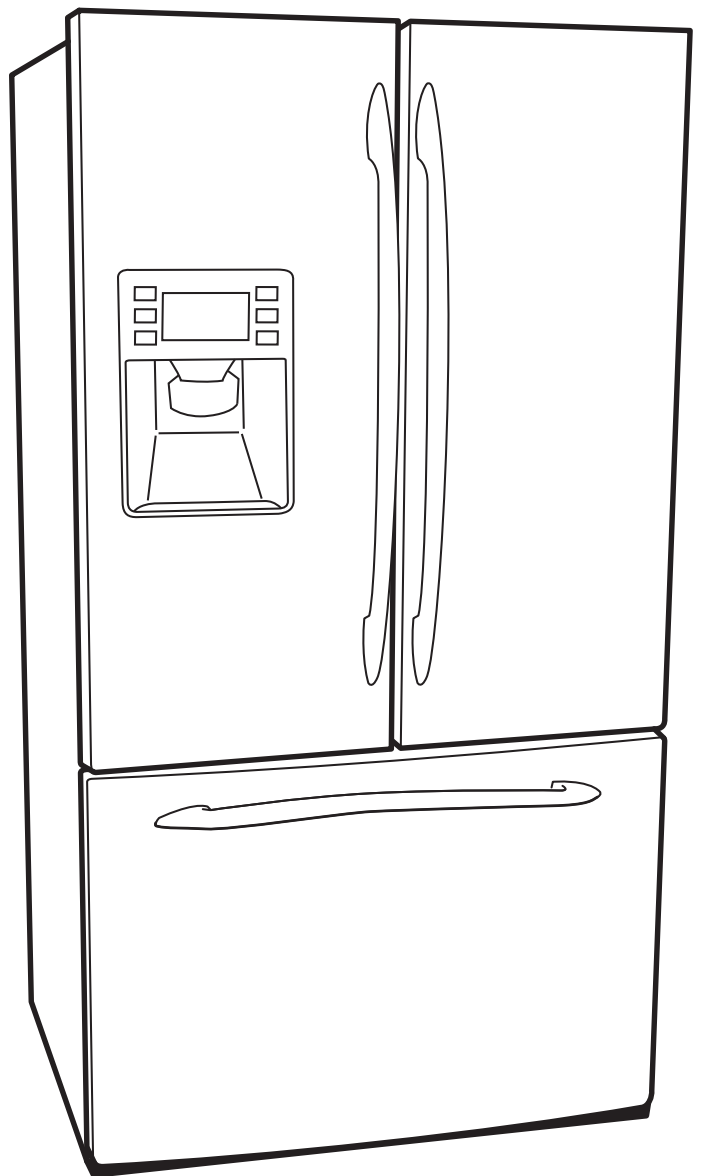

31-9203



GE Appliances  
General Electric Company  
Louisville, Kentucky 40225



### **IMPORTANT SAFETY NOTICE**

The information in this service guide is intended for use by individuals possessing adequate backgrounds of electrical, electronic, and mechanical experience. Any attempt to repair a major appliance may result in personal injury and property damage. The manufacturer or seller cannot be responsible for the interpretation of this information, nor can it assume any liability in connection with its use.

### **WARNING**

To avoid personal injury, disconnect power before servicing this product. If electrical power is required for diagnosis or test purposes, disconnect the power immediately after performing the necessary checks.

### **RECONNECT ALL GROUNDING DEVICES**

If grounding wires, screws, straps, clips, nuts, or washers used to complete a path to ground are removed for service, they must be returned to their original position and properly fastened.

*GE Appliances*  
*Technical Service Guide*  
*Copyright © 2010*

All rights reserved. This service guide may not be reproduced in whole or in part in any form without written permission from the General Electric Company.

## Table of Contents

3-Way Valve .....	41
Articulating Door Mullion .....	53
Auger Motor Assembly.....	52
Circuit Boards .....	38
Components Locator Views.....	15
Condenser Fan.....	29
Control Board Connector Locator .....	17
Control Features.....	12
Control Panel Operation - LED.....	57
Damper Assembly .....	47
Defrost Heaters .....	35
Dispenser Assembly .....	45
Dispenser Display Assembly .....	44
Dispenser Heater .....	46
Door Gaskets.....	20
Duct Heater .....	36
EMI Filter and Power Cord.....	37
Evacuation and Charging Procedure .....	9
Freezer Evaporator .....	25
Freezer Evaporator Cover .....	23
Freezer Fan .....	26
Fresh Food Evaporator .....	23
Fresh Food Evaporator Cover .....	21
Fresh Food Fan .....	28
Ice Bucket and Icemaker .....	50
Ice Room Blower .....	27
Installation .....	11
Interior Airflow.....	10
Interior Lights.....	20

Introduction.....	5
Inverter Board Compressor Codes .....	84
Inverter Compressor.....	40
Machine Compartment Cover .....	29
Nomenclature.....	6
Over Temperature Thermostats .....	34
Pantry Drawer Assembly .....	46
Pantry Drawer Control .....	47
Refrigeration Components .....	8
Refrigeration System .....	8
Replacing Evaporators Using the LOKRING Method .....	26
Replacing the 3-Way Valve.....	42
Replacing the 3-Way Valve Coil.....	42
Schematic.....	85
Technical Data.....	7
Test Mode Operation - LCD.....	61
Test Mode Operation - LED.....	68
Thermistors .....	31
Top Table.....	19
Troubleshooting.....	61
Vegetable and Fruit Drawers Shelf .....	46
Warranty .....	87
Water Tank .....	48

# Introduction

The new Profile 29-cubic foot capacity Bottom Mount Refrigerators are available with a LED control (PFSS9PKY) or a LCD control (PFSS9PSY). Both models have these following features:

- ENERGY STAR® qualified.
- Main board with integrated power supply.
- New variable speed inverter compressor has a discrete compressor inverter board and a series sealed system with a 3-way valve.
- Integrated Dispenser with Crushed Ice, Water, and Actual Temperature Display — Features a new 9-cube icemaker with water flow control sensor, new water tank, and a new ice bucket.
- New improved articulating door mullion attached to the left-side door provides a movable center mullion that maximizes access to the fresh food compartment.
- Secure-Close Door Systems — Securely pulls the doors and drawers shut, even after you release the handles.
- ClimateKeeper™ with Dual Evaporators — Uses two evaporators to maintain higher humidity for fresh foods.
- Freshness Center™ — Offers maximum convenience by utilizing two humidity-controlled drawers and 1 full-length adjustable temperature deli drawer.
- An external "air" thermistor changes the control setting based on ambient condition to keep the fresh food and freezer at the correct temperature.
- TurboCool™ — Rapidly cools the refrigerator compartment to cool foods quickly.
- TurboFreeze — Rapidly cools the freezer compartment to freeze foods quickly.
- LED Lighting — Casts a clean, beautiful light throughout the fresh food area of the refrigerator. (GE Reveal™ Lighting in freezer.)
- Available in white or black finish or stainless wrap.



Note: Features may vary by model.

# Nomenclature

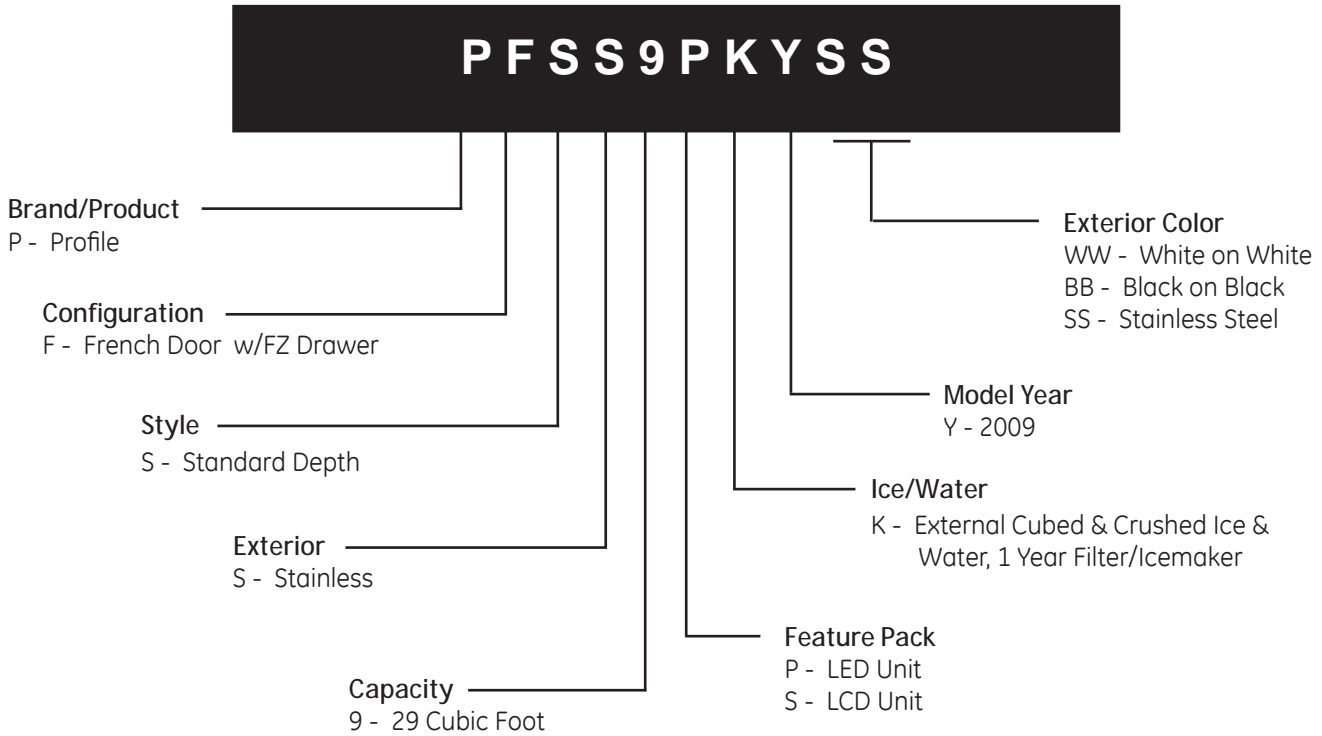

The nomenclature tag is located on the left wall of the fresh food compartment. It contains the following information:



- Model and Serial Number
- Minimum Installation Clearances
- Electrical Voltage, Frequency
- Maximum Amperage Rating
- Refrigerant Charge and Type

## Serial Number

The first two numbers of the serial number identify the month and year of manufacture.

*Example:* **AS123456S** = January, 2009

A - JAN	2009 - S
D - FEB	2008 - R
F - MAR	2007 - M
G - APR	2006 - L
H - MAY	2005 - H
L - JUN	2004 - G
M - JUL	2003 - F
R - AUG	2002 - D
S - SEP	2001 - A
T - OCT	2000 - Z
V - NOV	1999 - V
Z - DEC	1998 - T

The letter designating the year repeats every 12 years.

*Example:*

T - 1974  
T - 1986  
T - 1998

# Technical Data

## **DISCONNECT POWER CORD BEFORE SERVICING**

### **IMPORTANT - RECONNECT ALL GROUNDING DEVICES**

All parts of this appliance capable of conducting electrical current are grounded. If grounding wires, screws, straps, clips, nuts or washers used to complete a path to ground are removed for service, they must be returned to their original position and properly fastened.

## **ELECTRICAL SPECIFICATIONS**

Temperature Control (Position 5)	16-(-11)°F
Defrost Control (w/no door openings)	22hrs
Thermistor kilo-ohm resistance	-2°F.....30.6kΩ
	38°F.....11.6kΩ
	77°F.....5.0kΩ
Overtemperature Thermostat	140-104°F
Defrost Thermistor	50°F
Electrical Rating: 115V AC 60 Hz	5.3 A
Maximum Current Leakage	0.75 mA
Maximum Ground Path Resistance	0.14 Ω

## **NO LOAD PERFORMANCE**

Control Position 5/5 and Ambient of 70°F to 90°F

Fresh Food, °F	33 to 42°F
Frozen Food, °F	-7 to 3°F
Run Time, % @ 70°F	25 to 45
Run Time, % @ 90°F	45 to 75

## **IMPORTANT SAFETY NOTICE**

This information is intended for use by individuals possessing adequate backgrounds of electrical, electronic and mechanical experience. Any attempt to repair a major appliance may result in personal injury and property damage. The manufacturer or seller cannot be responsible for the interpretation of this information, nor can it assume any liability in connection with its use.

## **REFRIGERATION SYSTEM**

Compressor 29 Model	738~1270 BTU/hr
Minimum Equalized Pressure	
@ 90°F	55 to 65 PSIG
@ 110°F	70 to 82 PSIG

## **REFRIGERANT CHARGE (R134a)**

29 Model	5.643 ounces
----------	--------------

# Refrigeration System

## Refrigeration Components

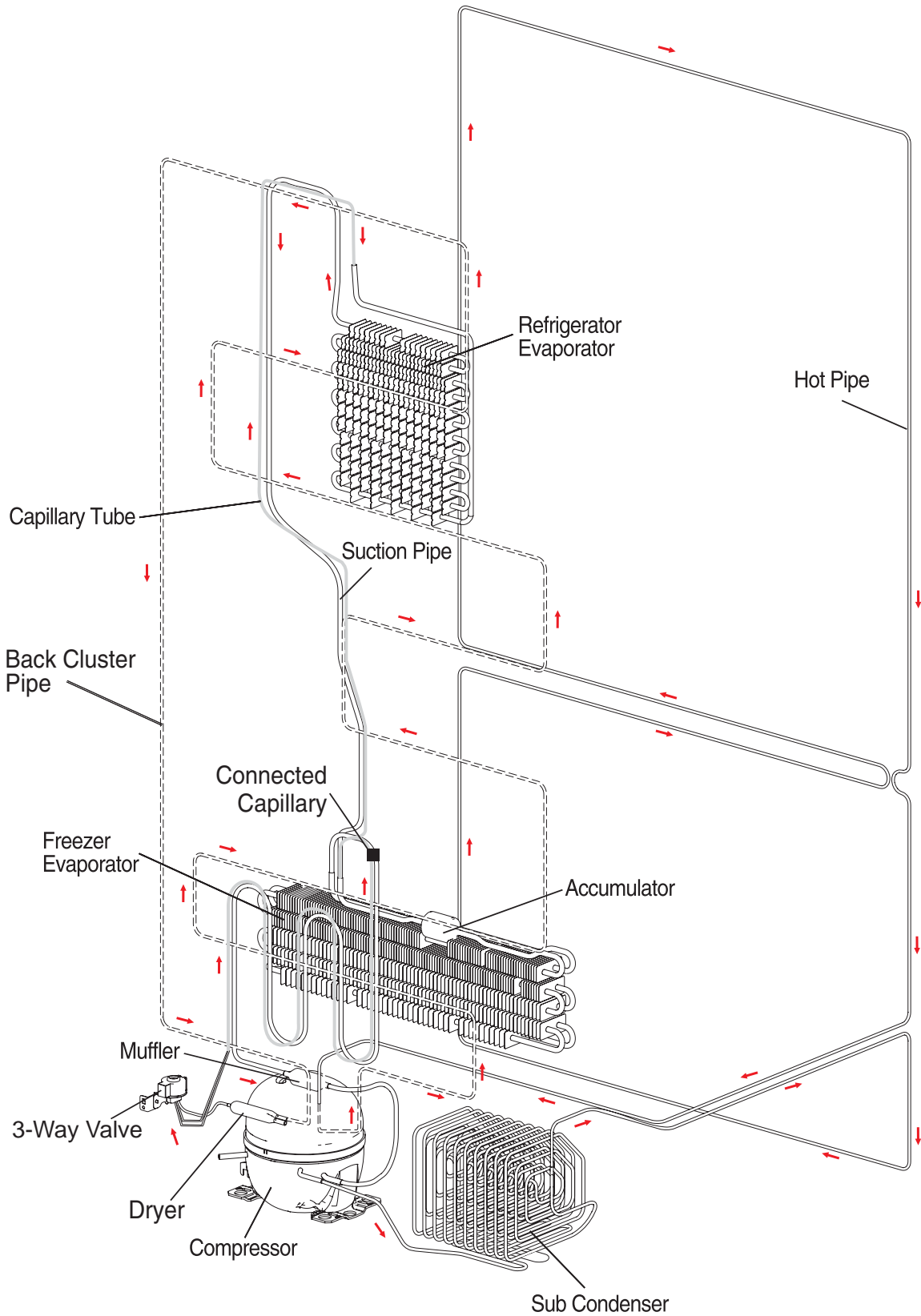

(Continued next page)



## Sealed System

The 29-cubic foot units have a series dual evaporator like previous models, but now have a new sealed system. They now use a multi-speed inverter compressor and a 3-way valve.

The compressor function is controlled by the inverter board mounted in the main board compartment. The 3-way valve is controlled by the main board. This valve will switch the unit to freezer-only cooling when the fresh food temperatures are satisfied.

There are no procedure changes for replacing the evaporator because the freezer evaporator capillary is inaccessible inside the cabinet.

The back cluster pipe (see illustration) is a hot loop of the sealed system. With reduced insulation thickness in the back of the cabinet, this loop warms the cabinet behind the evaporators to minimize the possibility of cabinet sweat.

### 3-Way Valve

The 3-way valve, like previous models, controls refrigerant flow to the evaporators. When the refrigerator is off, or in defrost, the valve is open to both evaporators allowing for equalization.

If both compartments require cooling, the valve opens to the fresh food only. Refrigerant flows through the fresh food evaporator and then through the freezer evaporator which has the common suction line to the compressor. When the fresh food is satisfied, the valve will open to the freezer only until the freezer is satisfied and the refrigerator cycles off.

## Evacuation and Charging Procedure

### WARNING:

- Before cutting or using a torch on refrigerant tubes, recover the refrigerant from the system using approved recovery equipment.
  - Never charge new refrigerant through the purge valve. This valve is always located on the high-pressure side of the system.
  - Never apply heat from any source to a container of refrigerant. Such action will cause excessive pressure in the container.
  - Always wear goggles when working with refrigerants and nitrogen holding charge in some replacement parts. Contact with these gases may cause injury.
1. Attach the hose from the R-134a charging cylinder to the process tube port on the compressor.
  2. Evacuate the system to a minimum 20-in. vacuum using the refrigerator compressor and recovery pump, which is attached to the new drier assembly.
  3. Turn off the recovery pump. Close the ball valve on the hose connected to the high-side port connection. Add 3 ounces of R-134a refrigerant to the system. Let the refrigerator operate and circulate the refrigerant for 5 minutes.
  4. Open the ball valve. Recover the purge/sweep charge using the recovery pump and the refrigerator compressor until a 20-in. vacuum is attained. Close the ball valve and remove the recovery hose.
  5. Charge the system with the exact amount of R-134a refrigerant specified.
  6. Disconnect the power cord to the refrigerator. This allows the pressure to equalize. After 3 to 5 minutes, the low-side pressure will be positive and then the hose-to-charging port can be disconnected.
  7. Using an electronic leak detector, check all brazed joints and both Schrader ports. Reinstall caps to the Schrader ports.

# Interior Airflow

Air Flow (side view)

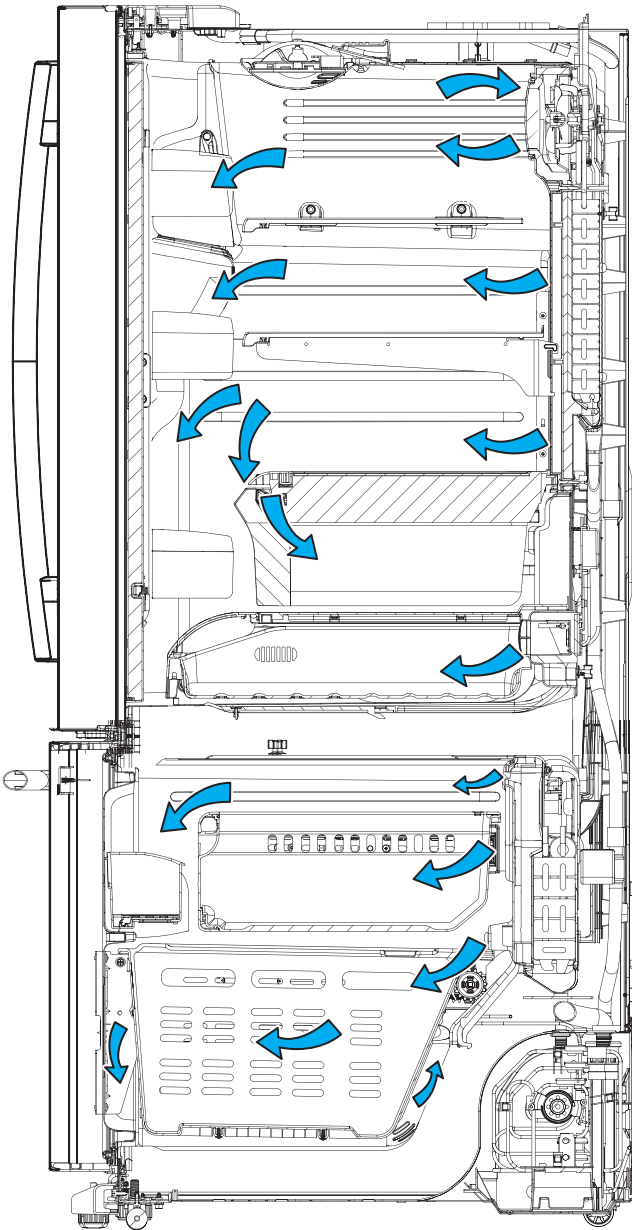

Air Flow (front view)

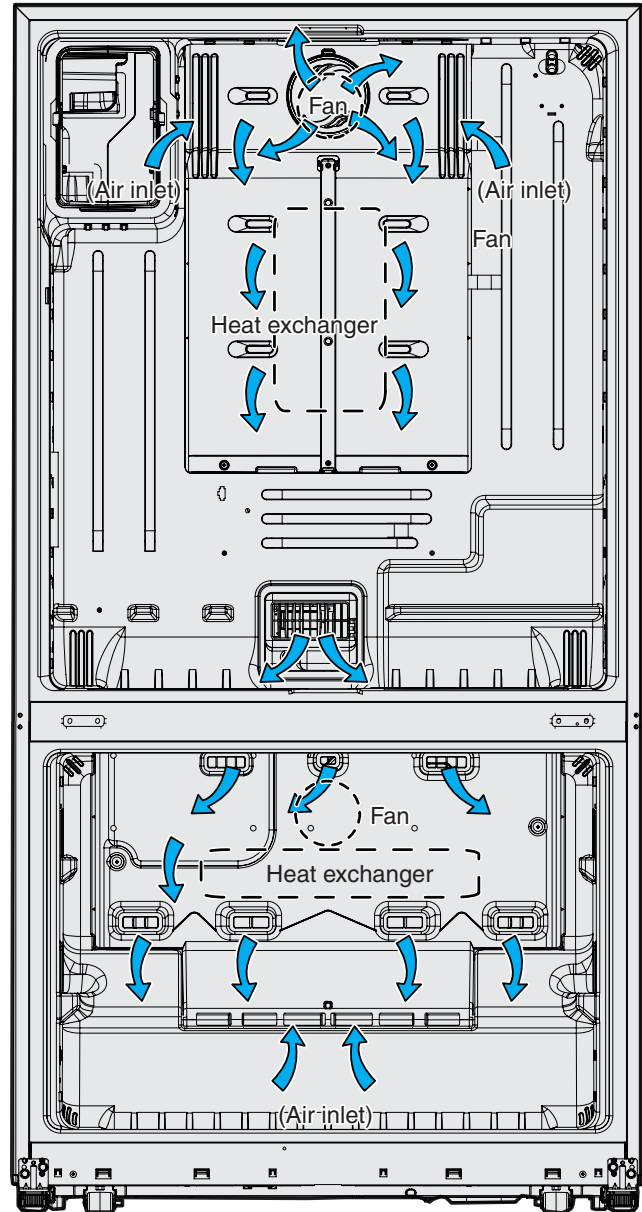

The fresh food evaporator fan forces air through the evaporator into the fresh food compartment. Air from the evaporator can also pass through the pantry room damper/heater assembly to the deli drawer, through the fresh food compartment, and return to the evaporator. The damper/heater assembly is controlled by the main control board. When open, the damper allows the chilled air from the fresh food evaporator to move into the deli drawer. Air returns from the fresh food compartment to the fresh food evaporator via two return vents located on the top left and right sides of the evaporator cover.

The freezer evaporator fan forces air through the evaporator into the freezer compartment. An additional ice room fan circulates air into and returns air from the ice room via plastic conduits embedded in the cabinet foam insulation. Air returns from the freezer compartment to the freezer evaporator via two return vents located on the bottom of the evaporator cover.

# Installation

## POWER CORD

The power cord of this appliance is equipped with a 3-prong (grounding) plug, which mates with a standard 3-prong (grounding) wall outlet to minimize the possibility of electric shock hazard from this appliance.

Have the wall outlet and circuit checked by a qualified electrician to make sure the outlet is properly grounded.

If the outlet is a standard 2-prong outlet, it is your personal responsibility and obligation to have it replaced with a properly grounded 3-prong wall outlet.

**WARNING:** Do not, under any circumstances, cut or remove the third (ground) prong from the power cord. For personal safety, this appliance must be properly grounded.

The refrigerator should always be plugged into its own individual electrical outlet, which has a voltage rating that matches the rating plate.

## USE OF EXTENSION CORDS

Because of potential safety hazards under certain conditions, we strongly recommend against the use of an extension cord.

However, if you must use an extension cord, it is absolutely necessary that it be a UL-listed (in the United States) or a CSA-listed (in Canada), 3-wire grounding type appliance extension cord having a grounding type plug and outlet, and that the electrical rating of the cord be 15 amperes (minimum) and 120 volts.

## REFRIGERATOR LOCATION

- Do not install the refrigerator where the temperature will go below 60°F (16°C) because it will not run often enough to maintain proper temperatures.
- Do not install the refrigerator where the temperature will go above 100°F (37°C) because it will not perform properly.
- Install it on a floor strong enough to support it fully loaded.

## CLEARANCES

Allow the following clearances for ease of installation, proper air circulation and plumbing, and electrical connections.

<b>Sides</b>	1/8" (3 mm)
<b>Top</b>	1" (25 mm)
<b>Back</b>	1" (25 mm)

# Control Features

## Control Panel for LCD Models

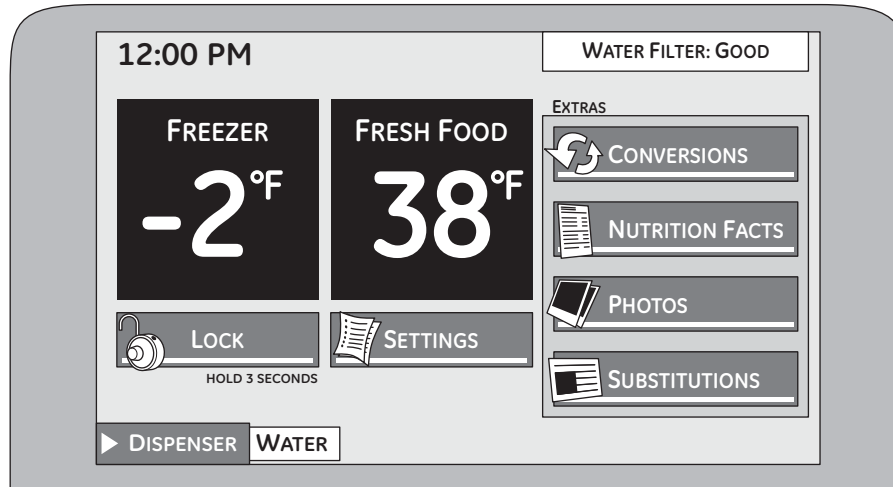

**NOTE:** The refrigerator is shipped with protective film covering the temperature controls. If this film was not removed during installation, remove it now.

The temperature controls are preset in the factory at **38°F** for the refrigerator compartment and **-2°F** for the freezer compartment. Allow 24 hours for the temperature to stabilize to the preset recommended settings.

The temperature controls can display both the **SET** temperature as well as the actual temperature in the refrigerator and freezer. The actual temperature may vary slightly from the **SET** temperature based on usage and operating environment.

Reset the LCD screen at any time by inserting a paper clip into the small hole next to the SD card slot under the front edge of the dispenser opening.

## The Home Screen

The **HOME** screen is the default display on the refrigerator. From this screen you can change the fresh food and freezer temperatures, select the desired ice and water dispenser setting and access other functions as listed below. To return to this screen at any time, press the **HOME** button in the lower right hand corner of the screen.

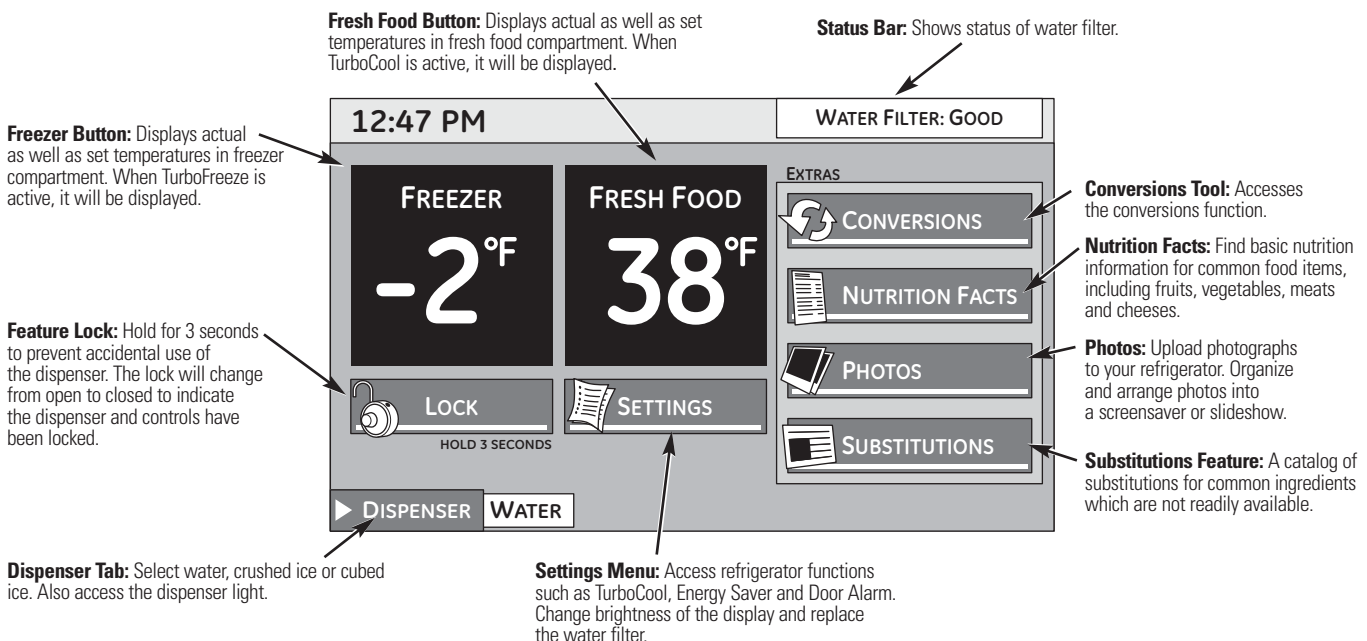

## Control Panel for LED Models

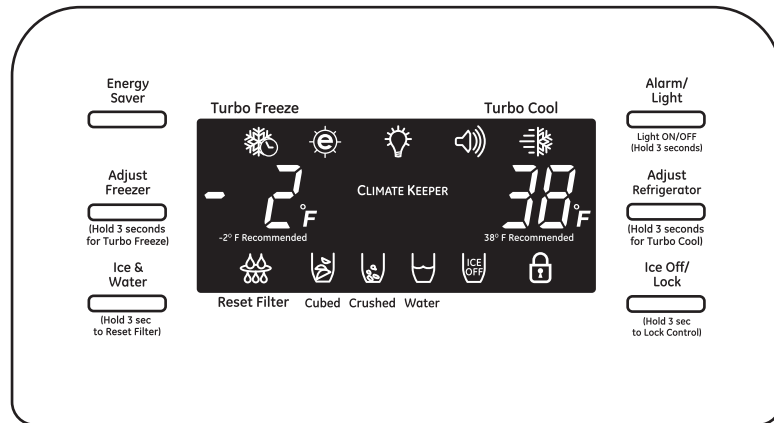

**NOTE:** The refrigerator is shipped with protective film covering the temperature controls. If this film was not removed during installation, remove it now.

The temperature controls are preset in the factory at **38°F** for the refrigerator compartment and **-2°F** for the freezer compartment. Allow 24 hours for the temperature to stabilize to the preset recommended settings.

The temperature controls can display both the **SET** temperature as well as the actual temperature in the refrigerator and freezer. The actual temperature may vary slightly from the **SET** temperature based on usage and operating environment.

### Changing the Temperature

**ADJUST  
REFRIGERATOR**

(Hold 3 sec  
for Turbo Cool)

**ADJUST  
FREEZER**

(Hold 3 sec  
for Turbo Freeze)

**To change the temperature**, press and release the **ADJUST FREEZER** or **ADJUST REFRIGERATOR** pad. The display will show the actual temperature. To change the temperature, tap either the **ADJUST FREEZER** or **ADJUST REFRIGERATOR** pad until the desired temperature is displayed.

Once the desired temperature has been set, the temperature display will return to the actual refrigerator and freezer temperatures after 10 seconds. Several adjustments may be required.

Each time you adjust controls, allow 24 hours for the refrigerator to reach the temperature you have set.

## Fresh Food Defrost Cycle

The refrigerator evaporator utilizes an adaptive defrost cycle that operates a metal sheath heater to remove frost from the evaporator.

If the main board senses any door opening, the defrost cycle is every 12 hours. Otherwise, the defrost cycle is 16 hours.

The control board determines the length of time the heater is energized. It does this by monitoring the fresh food evaporator thermistor. Once the temperature of the thermistor reaches 54°F (12°C), the control cycles the defrost heater off. A bimetal safety thermostat provides a backup in the event the evaporator thermistor fails. The safety thermostat prevents the temperature from exceeding 140°F (60°C).

## Freezer Defrost Cycle

The freezer evaporator utilizes an adaptive defrost cycle that operates a metal sheath heater to remove frost from the evaporator.

If the main board senses any door opening, the defrost cycle is every 12 hours. Otherwise, the defrost cycle is 16 hours.

The control board determines the length of time the heater is energized. It does this by monitoring the freezer evaporator thermistor. Once the temperature of the thermistor reaches 50°F (10°C), the control cycles the defrost heater off. A bimetal safety thermostat provides a backup in the event the evaporator thermistor fails. The safety thermostat prevents the temperature from exceeding 140°F (60°C).

## Light Time-Out Function

The refrigerator incorporates a light time-out function for the fresh food and freezer sections. If either of the fresh food doors or the freezer drawer is left open for 10 minutes, the main control board will turn off the lights in that section. If the open door or drawer is closed, and then reopened, the timer in the main control board will reset for another 10 minute count.

## Dispenser Lock

When the dispenser system is locked, actual and set temperatures can be viewed but no dispenser command will be accepted. This includes the dispenser cradle and will prevent accidental dispensing that may be caused by children or pets. If a pad or the cradle is depressed with the system locked, it will not be acknowledged.



# Components Locator Views

## Fresh Food Compartment

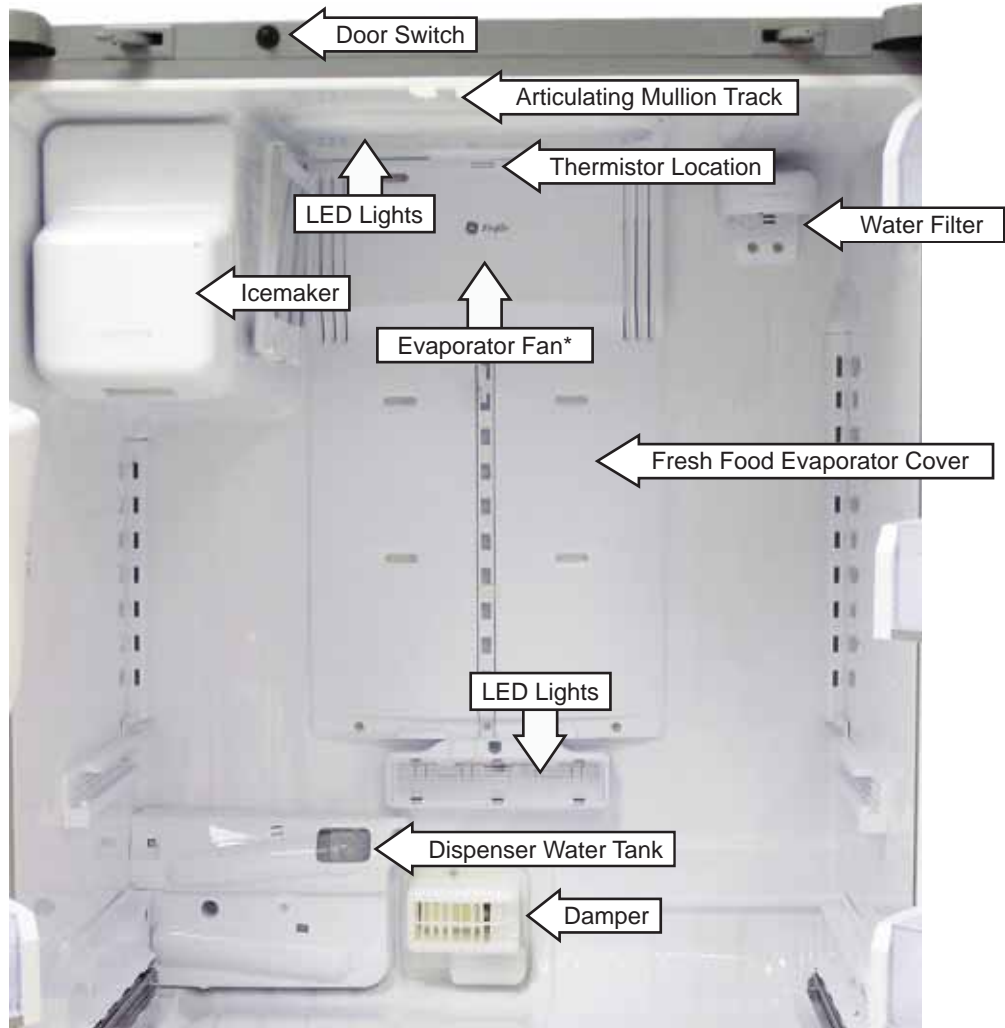

\*The evaporator fan is attached to the inside of the cover.

## Fresh Food Evaporator (shown with cover removed)

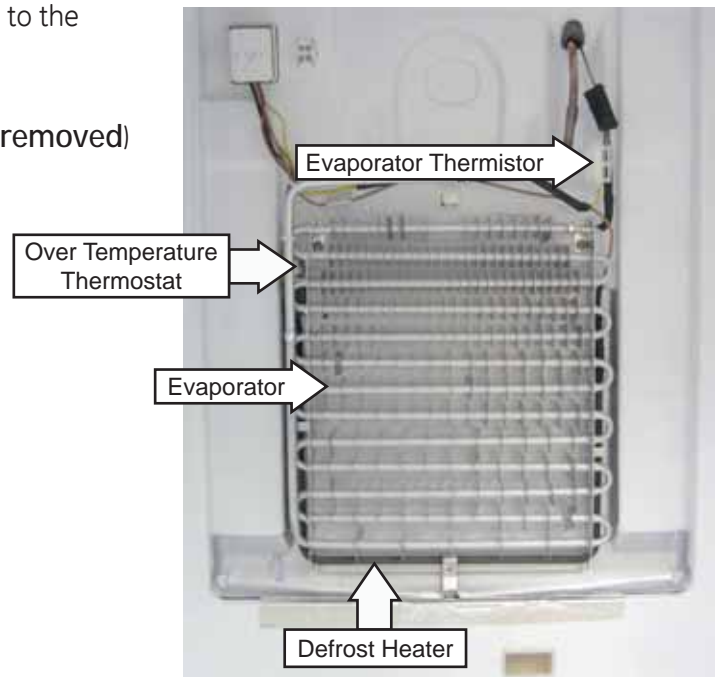

(Continued next page)



## Freezer Compartment

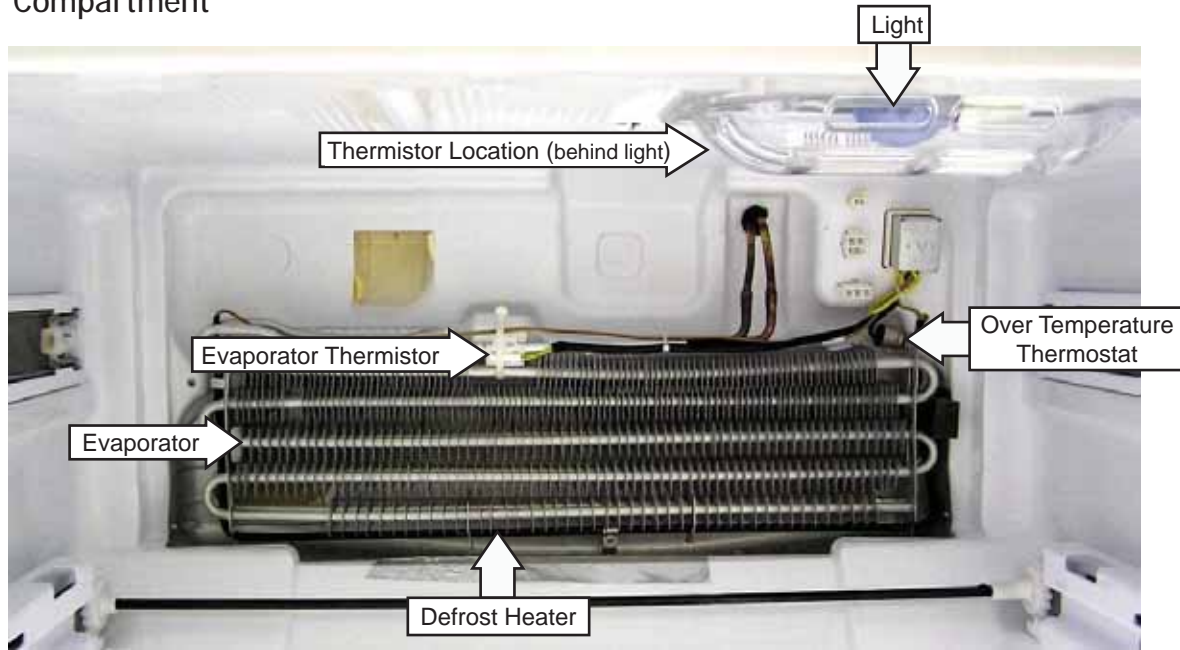

Note: The evaporator fan is attached to the inside of the evaporator cover (not shown).

## Rear View

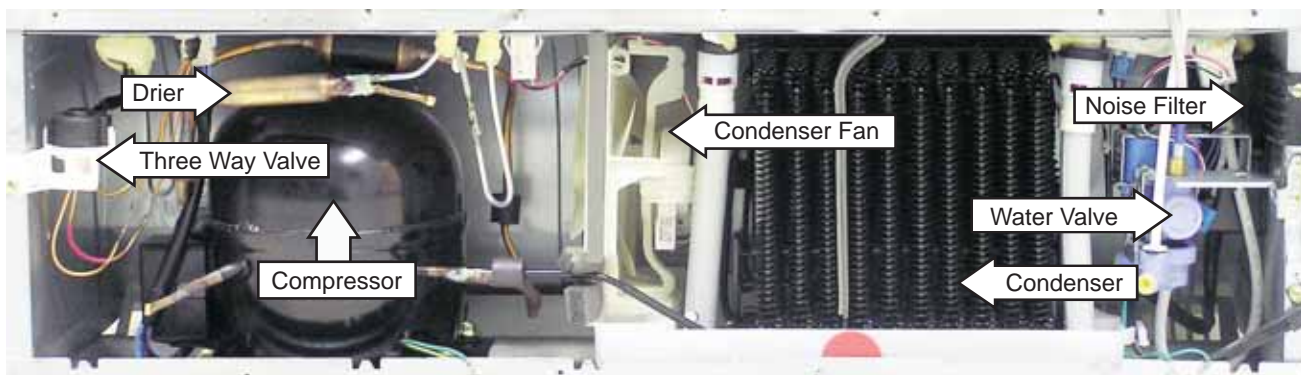
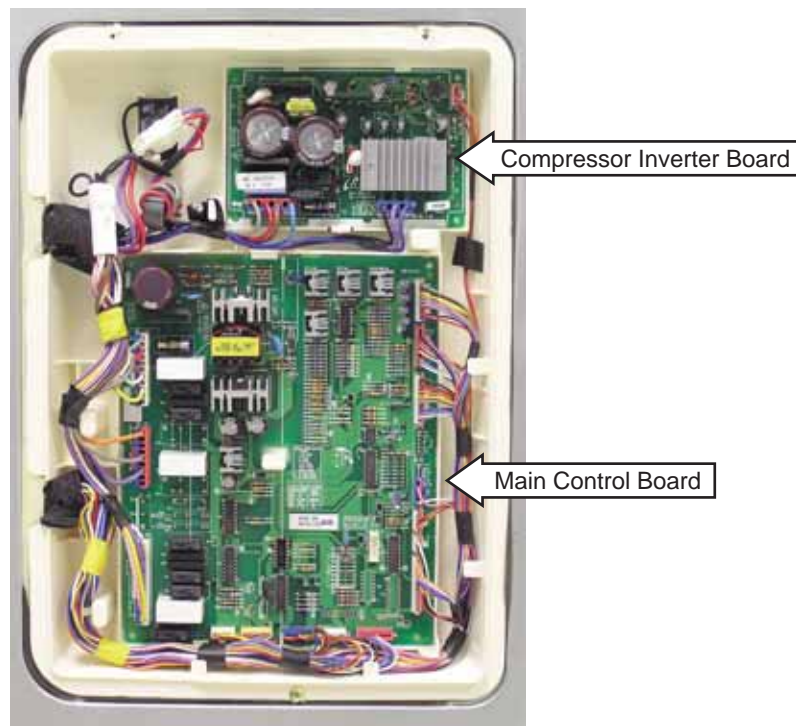



# Control Board Connector Locator

## Main Control Board

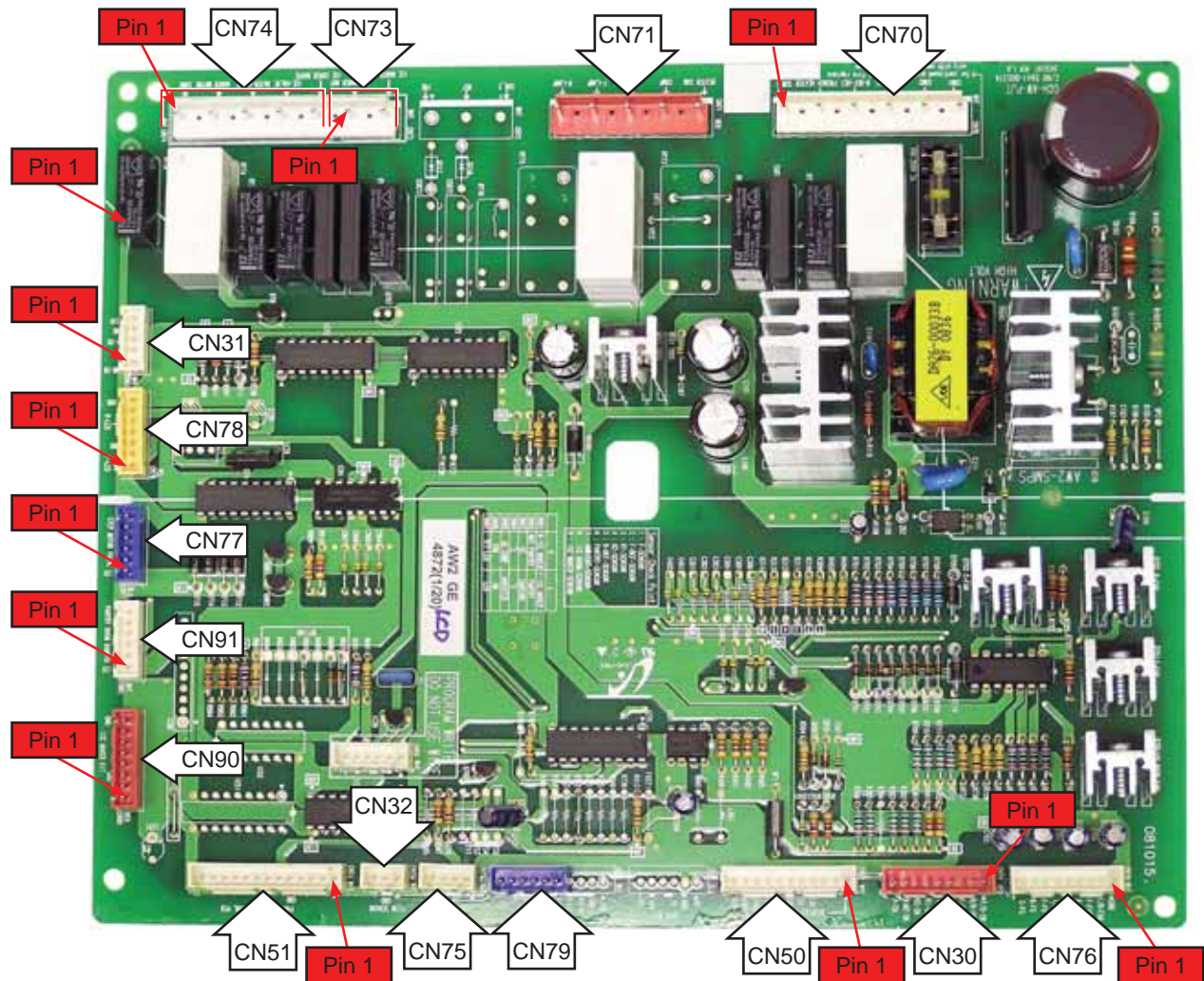

CN30 - FZ Door Switch, FF Left and Right Door Switches, FZ Sensor, FZ Defrost Sensor, FF Sensor, FF Defrost Sensor, Pantry Sensor

CN31 - Ambient Sensor, Ice Room Sensor

CN32 -Water Valve Flow Sensor

CN50 - Dispenser PBA Panel LED/LCD

CN51 - Pantry Panel Control

CN70 - 120V AC Input, FZ Defrost Heater, FF Defrost Heater, Ice Pipe Heater, French Heater, Dispenser Heater, Ice Water Heater

CN71 - Neutral, FZ Room Lamp

CN73 - Icemaker Motor

CN74 - Ice Dispenser, Water Valve

CN75 - Inverter Board Control

CN76 - C Fan Motor, FF Fan Motor, FZ Fan Motor, Ice Room Fan Motor

CN77 - 3-Way Valve

CN78 - FF LED Lights, Left and Right Veg. LED Lights

CN79 - Water Tank Heater

CN90 - Icemaker

CN91 - Pantry Room Damper

## Inverter Board

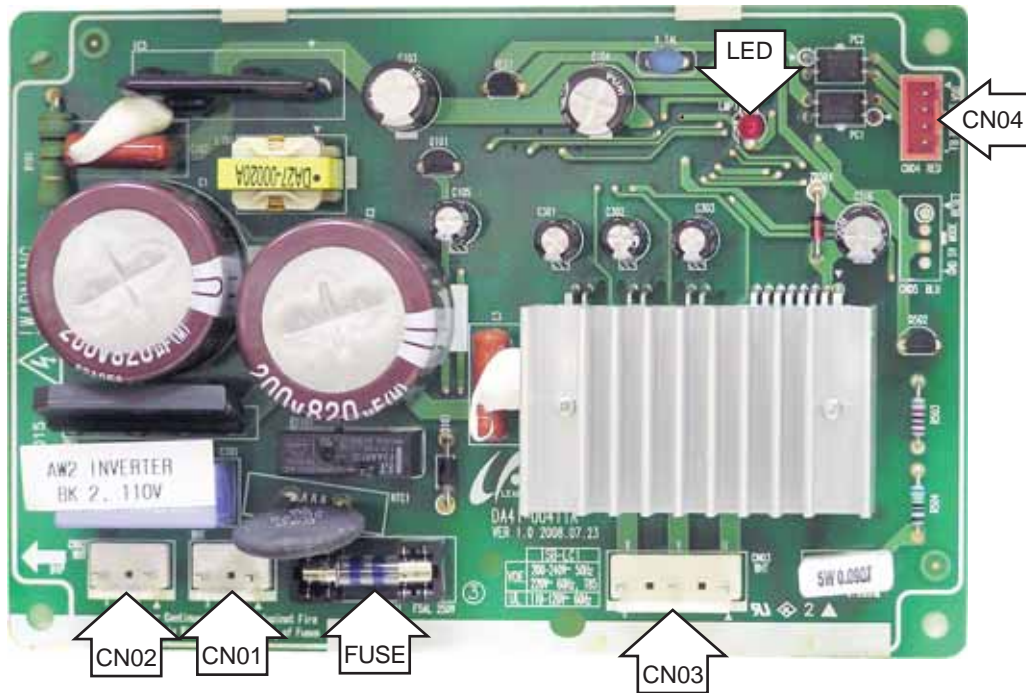

CN01 - Compressor OLP

CN02 - 115 VAC Input

CN03 - Compressor

CN04 - Main Board (CN75)

## Top Table

The top table is located on top of the refrigerator. The top table houses 2 reed switches and covers, both door hinges, ambient sensor, wire harnesses, and the dispenser water tubing disconnect. Two hinge tabs position the top table over both door hinges and 3 screws attach it to the cabinet.

### To remove the top table:

1. Open both doors.
2. Insert a flat blade screwdriver under each of the 2 top table caps at the pry point. Then carefully pry them from the top table.

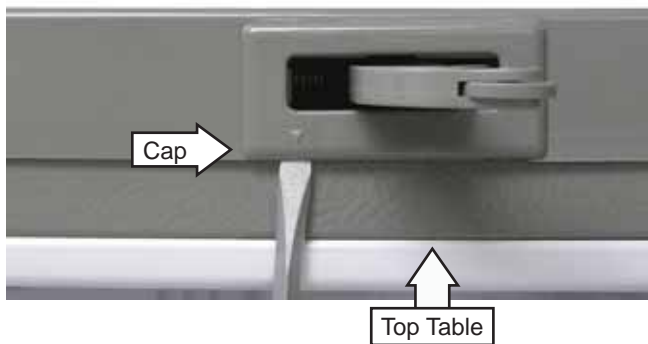

3. Remove the 3 recessed Phillips-head screws that hold the top table to the cabinet.
4. Pull each side of the top table up to release each hinge tab.

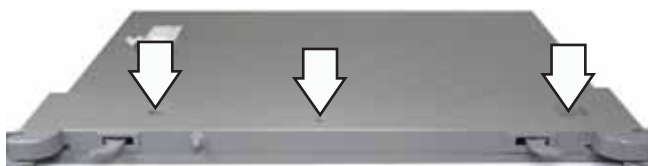

5. Place the top table upside down on top of the cabinet and disconnect both reed switch wire harnesses.

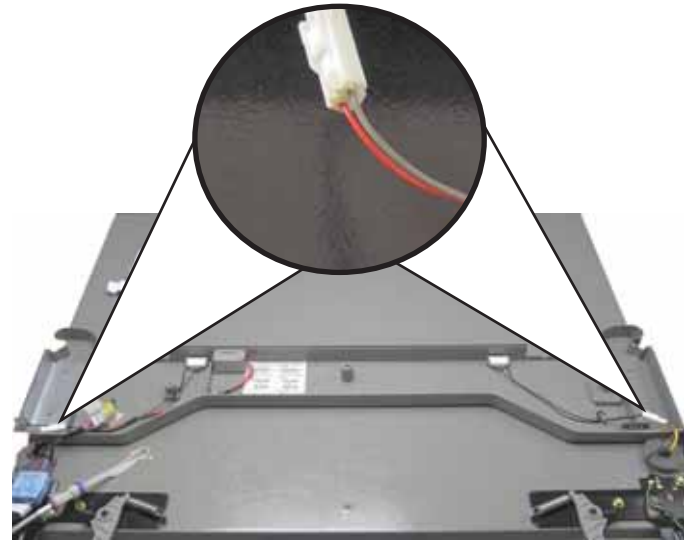

### Door Reed Switches and Door Magnets

The top table houses 2 reed switches, (1 for each door). Each switch informs the main control board the status of each door (open or closed). Each switch is activated by a magnet recessed in the top of each door.

Replacement table tops are supplied with the switches installed. The switches are also available separately.

To replace the reed switches, it is necessary to remove the top table (See *Top Table*.) and place it up side down on a protective surface.

**Note:** The reed switches may be lightly glued to the top table. It will be necessary to carefully pry and separate the switch from the glue.

Each reed switch is held in place by small tabs that can be carefully pried back.

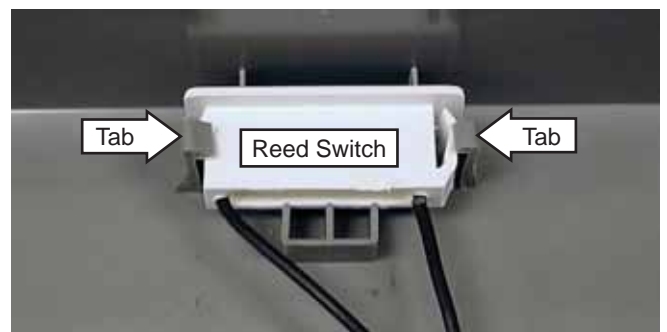



Each door magnet is located in a recess at the top of each door. Using a small flat blade screwdriver, each magnet can be removed by carefully prying each side out from the recess.

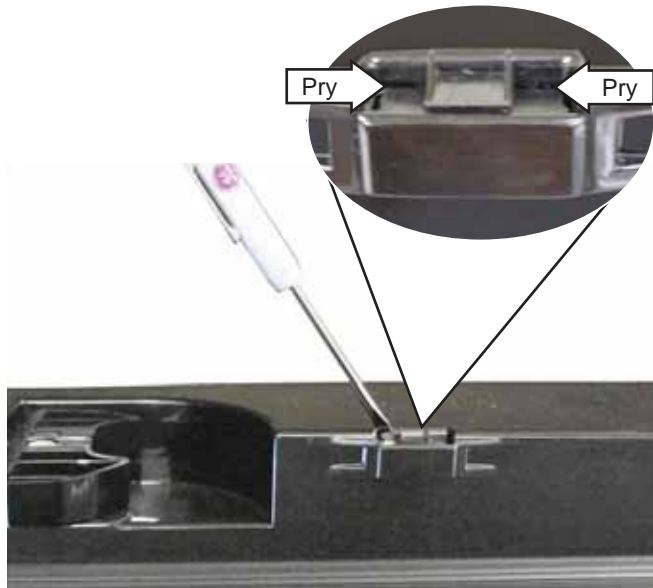

## Door Gaskets

The fresh food and freezer doors have magnetic gaskets that create a positive seal to the front of the steel cabinet. The magnetic door gaskets are secured to the doors by a barbed edge that locks into a retainer channel.

To remove and replace the door gasket:

1. Starting at any corner, pull the old gasket out of the retaining channel.
2. Soak the new gasket in warm water to make it pliable.
3. Push the barbed edge of the gasket into the retainer channel.



## Interior Lights

### Freezer Light

To replace the freezer light:

1. Unplug the refrigerator.
2. Remove the freezer upper drawer. (See *Control Features*.)
3. Press in on the back of the light cover and then lower it down and out.



4. Replace the bulb with an appliance bulb of the same or lower wattage, and reinstall the light cover.

**Note:** When reinstalling the light cover, make sure all top tabs snap securely in place.

5. Reinstall the upper drawer and plug the refrigerator back in.

### Refrigerator LED Light

To replace the refrigerator LED light:

1. Unplug the refrigerator.
2. Press in on the back of the LED light cover and then lower it down.



(Continued next page)

3. Remove the 2 Phillips-head screws that hold the LED light housing to the ceiling of the refrigerator.



4. Disconnect the LED light wire harness.



5. Remove the 2 Phillips-head screws and the LED board.



## Fresh Food Evaporator Cover

The fresh food evaporator cover is held to the back wall of the refrigerator with a Phillips-head screw and 2 tabs.

To remove the fresh food evaporator cover:

1. Remove the 2 fruit and vegetable drawers and the shelves that are in front of the evaporator cover.
2. Using a small flat blade screwdriver, pry off the cap from the top of the shelf angle.



3. Remove the 2 Phillips-head screws that attach the shelf angle to the cover.
4. Remove the 2 Phillips-head screws that hold the evaporator cover to the back wall.

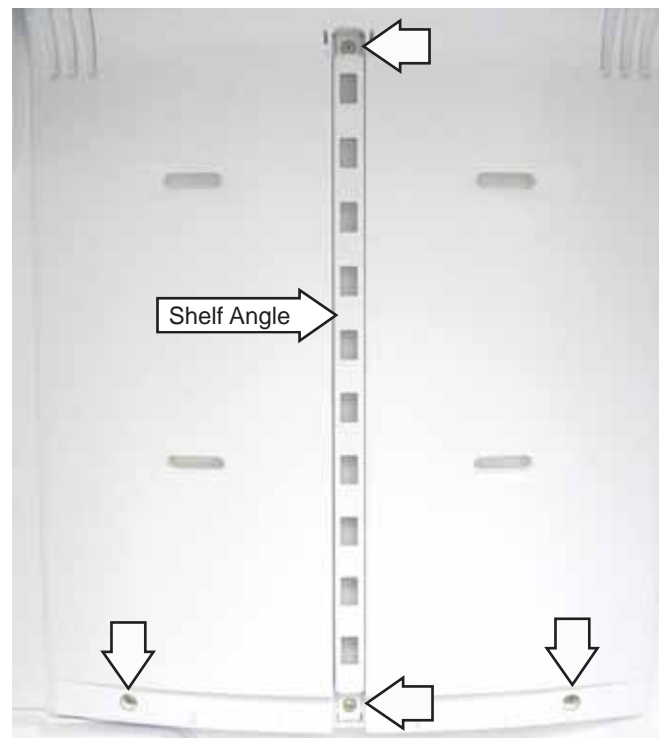

(Continued next page)

5. Grasp the shelf angle near the bottom and pull it out and down.



6. Pull the cover out at the bottom and then lower the cover.



**Note:** Behind the cover there is a recessed area in the back wall that houses the evaporator assembly. The top of the cover is inserted into the top of the recess and the sides have 6 tabs that lock into the recess.

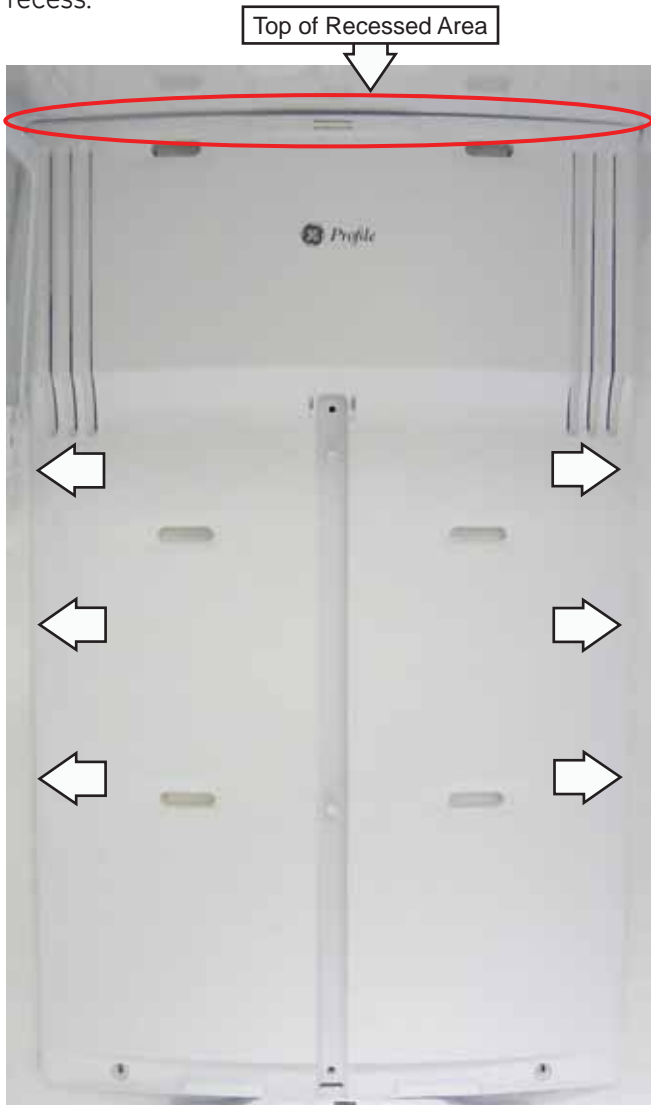

7. Turn the front of the cover towards the icemaker and disconnect the evaporator fan motor and fresh food thermistor wire harnesses.

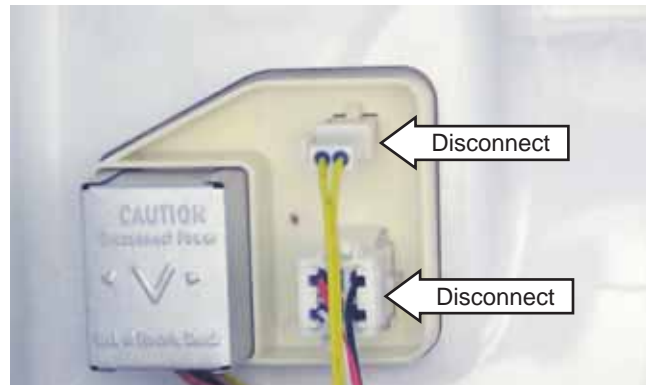

## Fresh Food Evaporator

**WARNING:** Sharp edges may be exposed when servicing. Use caution to avoid injury. Wear Kevlar gloves or equivalent protection.

The following components must be removed in the appropriate order to access the fresh food evaporator:

1. Remove the fresh food evaporator cover. (See *Fresh Food Evaporator Cover*.)
2. Push in the sides of the housing cover and pull out the cover.



3. Disconnect the 3 fresh food evaporator defrost component harnesses.

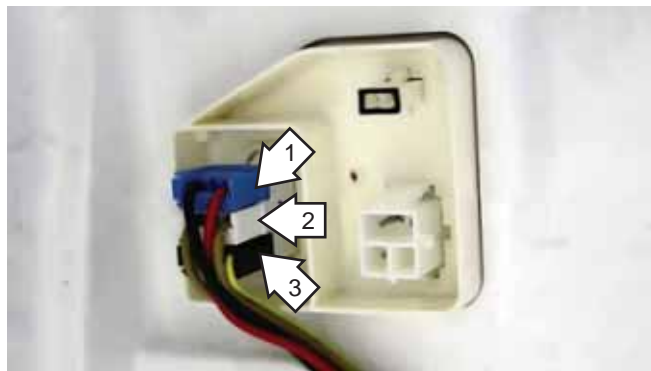

Defrost Components		
No.	Component	Wire Colors
1	Bimetal Thermostat	Red and Black
2	Defrost Heater	Tan
3	Thermistor	Yellow

4. Peel off the reflective tape from the drain tray.
5. Remove the 2 Phillips-head screws that hold the evaporator to the back wall of the refrigerator.
6. Carefully pull the evaporator up to remove the heat conducting tab from the drain inlet in the recess.

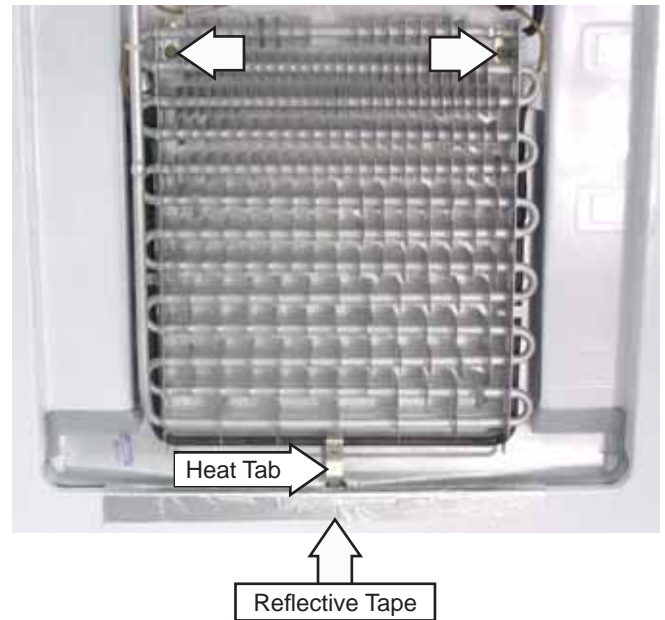

## Freezer Evaporator Cover

The freezer evaporator cover is held to the back wall of the refrigerator with 2 recessed Phillips-head screws.

To remove the freezer evaporator cover:

1. Remove the freezer basket and drawer. (See *Freezer Basket and Drawer*.)
2. Remove the four 10-mm hex-head bolts (2 on each side) that attach the drawer front to the rail assembly.



(Continued next page)

3. Tilt the bottom of the drawer out and lift the drawer off the rail assembly.
4. Place the drawer front on a protected surface.



5. Using a flat blade screwdriver, press in the rail lock tab on the left side rail cover. Slide the rail out slightly to cover the lock tab. Repeat this procedure on the right-side rail.



6. Evenly pull the rail assembly away from the refrigerator until both rails are clear of the cabinet.

**Note:** Behind the cover there is a recessed area in the back wall that houses the evaporator assembly. The cover is held in place by 2 recessed Phillips-head screws and 3 tabs inserted into the bottom of the recess.

7. Remove the 2 recessed Phillips-head screws that attach the cover to the back wall of the freezer compartment.



8. Lift the bottom of the cover up and pull cover towards the front of the refrigerator.



9. Disconnect the 3 freezer evaporator cover component harnesses.

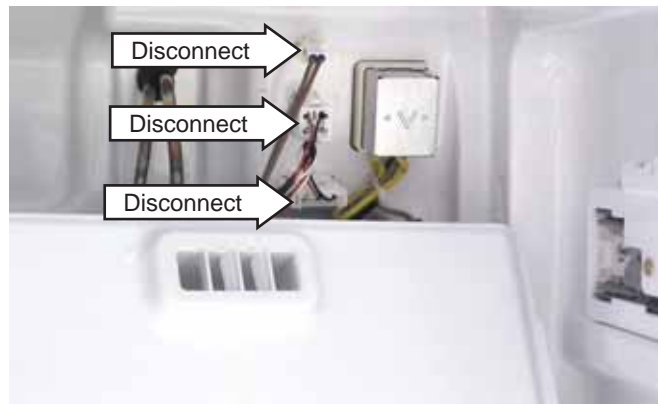



## Freezer Evaporator

**WARNING:** Sharp edges may be exposed when servicing. Use caution to avoid injury. Wear Kevlar gloves or equivalent protection.

The following components must be removed in the appropriate order to access the freezer evaporator:

1. Remove the freezer evaporator cover. (See *Freezer Evaporator Cover*.)
2. Push in the sides of the housing cover and pull out the cover.



3. Disconnect the 3 freezer evaporator defrost component harnesses.

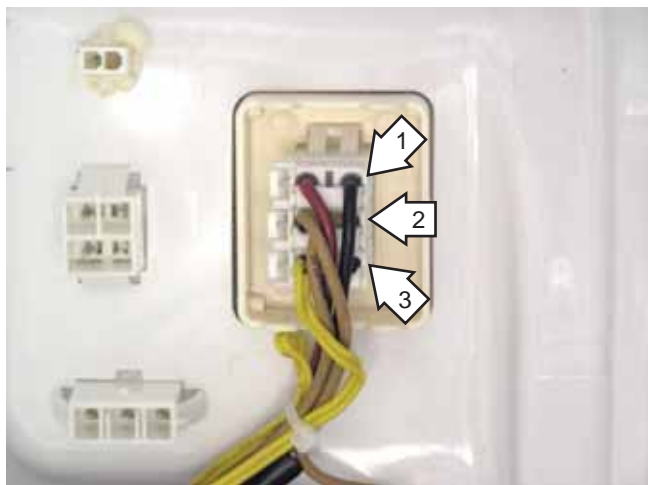

Defrost Components		
No.	Component	Wire Colors
1	Bimetal Thermostat	Red and Black
2	Defrost Heater	Tan
3	Thermistor	Yellow

4. Pull out the foam block from the right side of the evaporator.



5. Peel off the reflective tape from the drain tray.

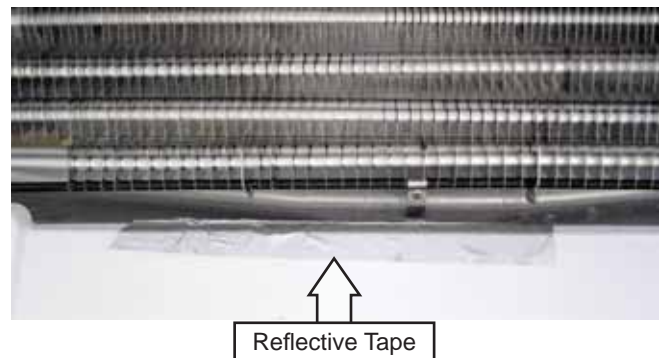

6. Carefully pull the evaporator out and up to remove the heat conducting tab from the drain inlet in the recess.



## Replacing Evaporators Using the LOKRING Method

### Fresh Food Evaporator

#### Parts Needed:

- Fresh Food Evaporator
- Drier Assembly
- Access Tube (part # WJ56X61)
- LOKRING Connectors- (part # WR97X10031)  
(part # WR97X10085)  
(part # WR97X10021)

### Freezer Evaporator

#### Parts Needed:

- Freezer Evaporator
- Drier Assembly
- Access Tube (part # WJ56X61)
- LOKRING Connectors- (2 of part # WR97X10021)

The LOKRING method provides a durable, vibration-resistant compression connection for both copper and aluminum tubing. The connectors can be used within a temperature range of -58°F (-50°C) to +302°F (150°C) and have a higher burst strength than that of the tube itself. Refer to Service Guide #31-9067 for complete instructions on using the LOKRING method of installing an evaporator.

## Freezer Fan

The freezer fan is attached to the inside of the freezer evaporator cover.

#### To remove the freezer fan assembly:

1. Remove the freezer evaporator cover (See *Freezer Evaporator Cover*.) and place the cover assembly on a protected surface so that the inside faces upward.
2. Note the positioning of the wiring and untape the wire harnesses.

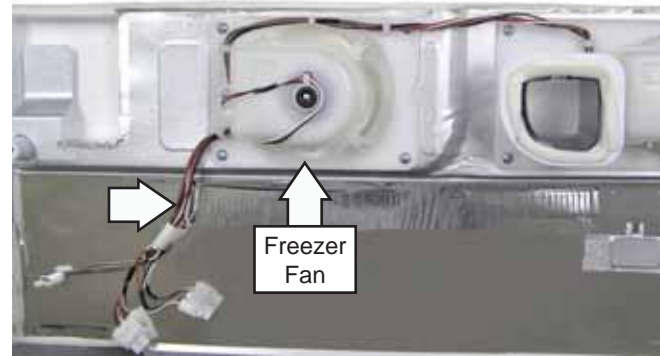

3. Remove the plastic wire tie and the freezer fan wires from the retainer.
4. Remove the 4 Phillips-head screws that attach the fan housing to the evaporator cover.

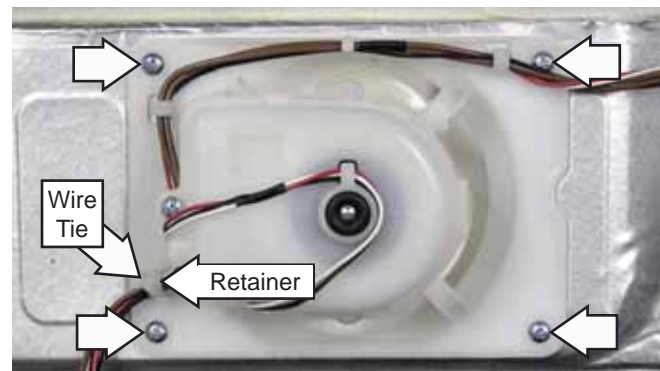

(Continued next page)

5. Remove the fan housing and place it blade-side up on the protected surface.

**Note:** An anti-slip adhesive is applied to the fan blade hub during factory assembly and the fan blade may be difficult to remove.

6. Using 2 large flat blade screwdrivers, place each screwdriver under the fan blade hub, 180° apart, and over 2 opposite legs of the housing as shown. Carefully pry up and remove the fan blade from the motor shaft.



7. Remove the 2 Phillips-head screws, then rotate the fan motor 90° counterclockwise and remove the motor from the fan housing.



## Ice Room Blower

The ice room blower is attached to the inside of the freezer evaporator cover.

**To remove the ice room blower assembly:**

1. Remove the freezer evaporator cover (See *Freezer Evaporator Cover*.) and place the cover assembly on a protected surface so that the inside faces upward.
2. Note the positioning of the wiring and untape the wire harnesses.
3. Remove the 2 plastic wire ties (not shown) and the blower wires from all retainers.
4. Remove the 4 Phillips-head screws that attach the blower housing to the evaporator cover.

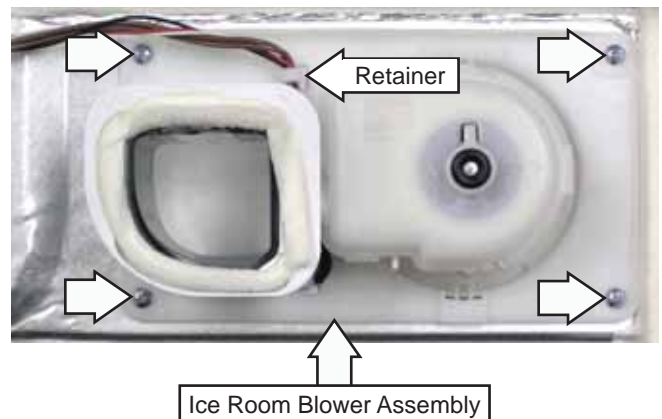

5. Remove the blower housing and place it blower wheel-side up on the protected surface.

**Note:** An anti-slip adhesive is applied to the blower wheel hub during factory assembly and the blower wheel may be difficult to remove.

6. Firmly grasp the blower wheel and pull it off the motor shaft.



7. Remove the 2 Phillips-head screws. Rotate the blower motor 90° counterclockwise and remove the motor from the blower housing.

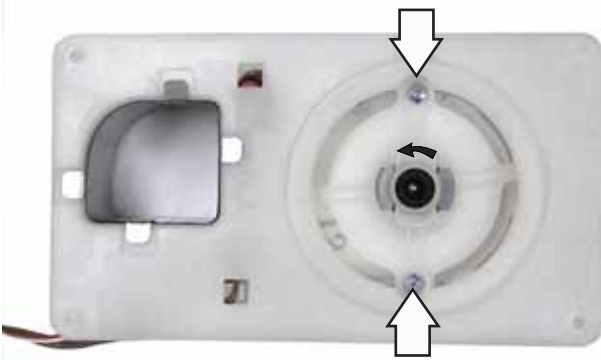

## Fresh Food Fan

The fresh food fan motor is attached to the inside of the fresh food evaporator cover.

To remove the fresh food fan:

1. Remove the fresh food evaporator cover. (See *Fresh Food Evaporator Cover*.)
2. Peel off the masking tape from the top and the reflective tape from the bottom of the fan motor housing.
3. Remove the 4 Phillips-head screws that attach the fan housing to the evaporator cover.

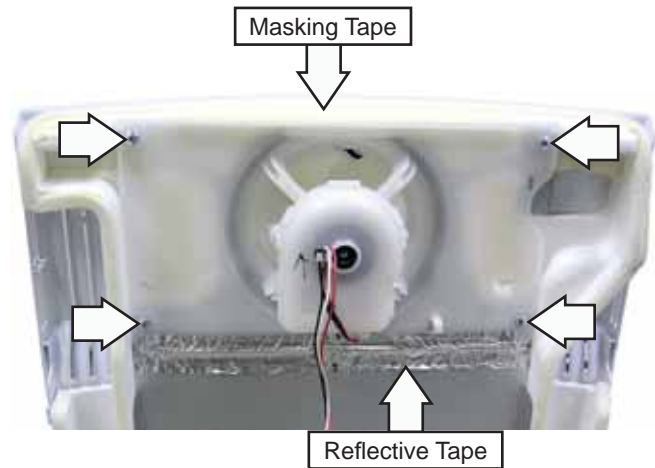

**Note:** The fan blade may be difficult to remove from the motor shaft. Care must be taken to avoid damage to the fan blade and/or fan housing.

4. Place the fan housing blade-side up on a protective surface.
5. Using 2 large, flat blade screwdrivers, place each screwdriver under the fan blade hub, 180° apart, and over 2 opposite legs of the housing as shown. Carefully pry up and remove the fan blade from the motor shaft.

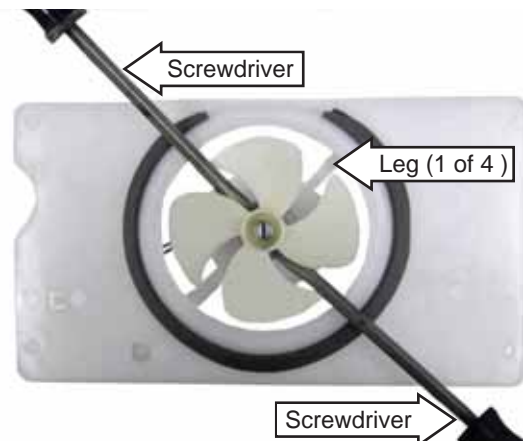

(Continued next page)



- Remove the 2 Phillips-head screws. Rotate the fan motor 1/4-turn counterclockwise and remove the motor from the fan housing.

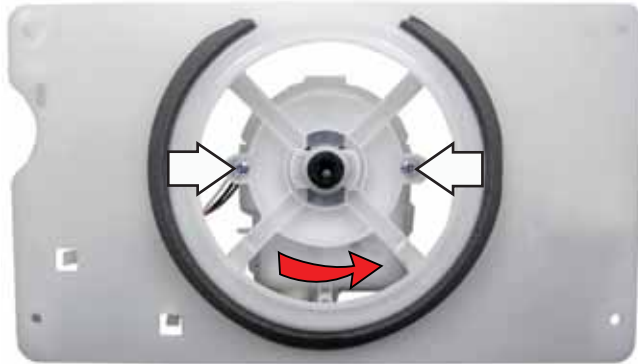

### Machine Compartment Cover

The machine compartment cover is held to the rear of the refrigerator with 8 Phillips-head screws and 2 tabs. After removing the screws, the cover can then be lifted from the tabs.

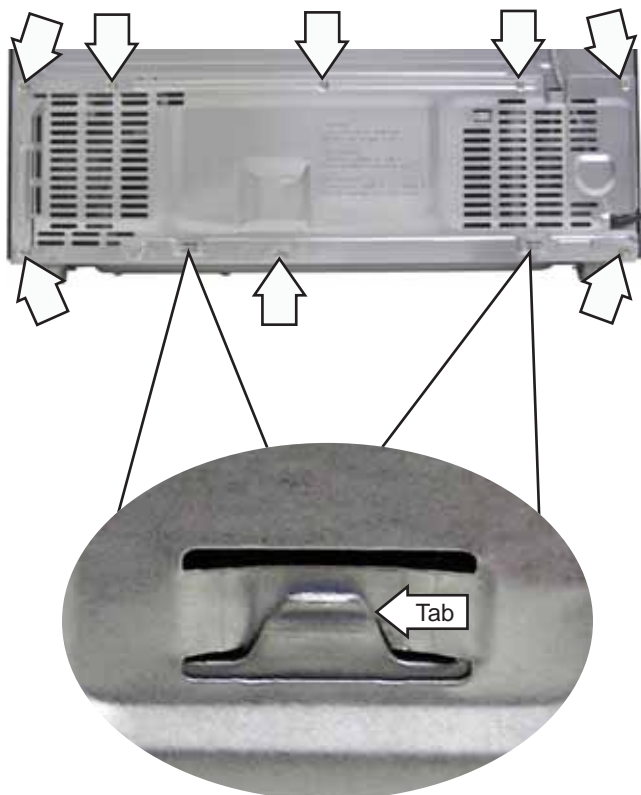

**Note:** When installing the machine compartment cover, be sure to place the cover over the 2 tabs before installing screws.

### Condenser Fan

The condenser fan motor is mounted in the machine compartment between the compressor and the condenser. The machine compartment cover must be properly installed to ensure air passes through the condenser. (See *Machine Compartment Cover*.)

### Condenser Fan Parameters

Room Temperature	Condenser Fan Operation
Above 66°F	Fan operates with compressor.
61 - 65°F	Fan has 5-minute delay, then operates with compressor.
Below 60°F	Condenser fan does not operate at all.

### To remove the condenser fan:

- Remove the machine compartment cover. (See *Machine Compartment Cover*.)
- Disconnect the fan wire harness.
- Using a flat blade screwdriver or fingertip, simultaneously lift the front tab of the fan housing and pull the fan assembly out approximately 1 inch.

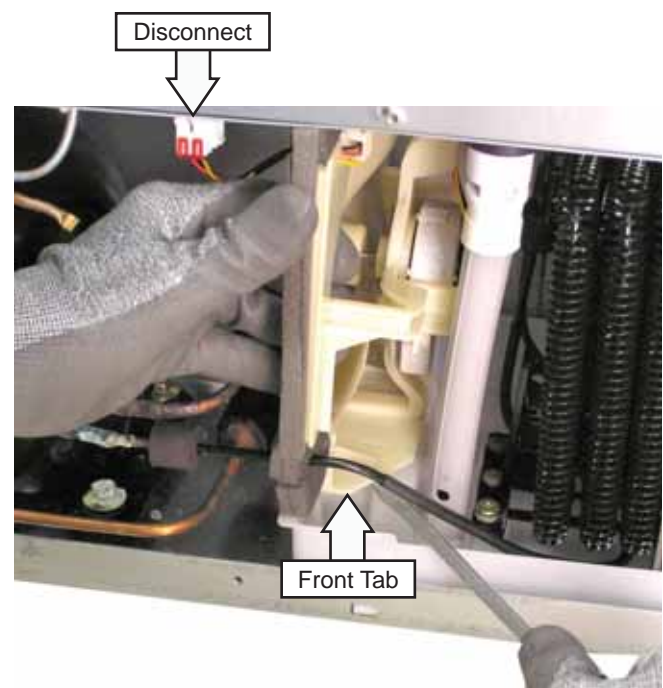

4. Rotate the fan assembly clockwise and then carefully maneuver the fan assembly out of the machine compartment.



7. Note the routing of the wiring through the retainers and the position of the motor and clamp. Remove the wiring from the retainers.

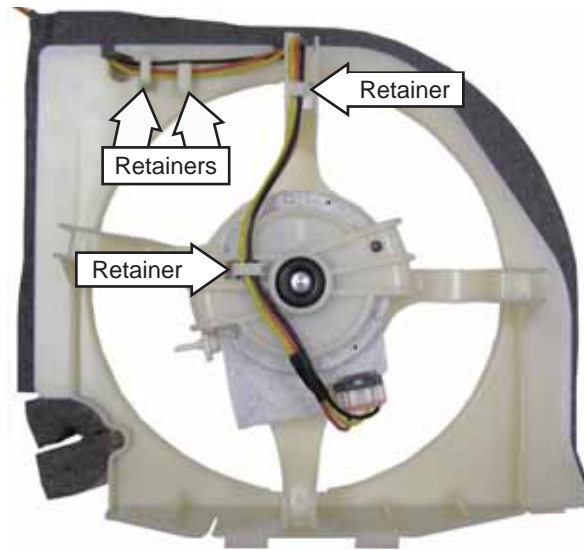

5. Using a flat blade screwdriver, remove the spring clip.

6. Pull the fan blade off the motor shaft.

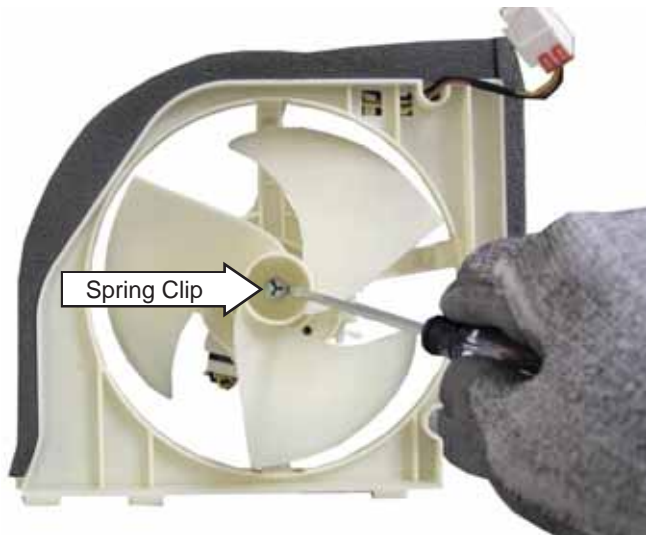

8. Remove the 2 Phillips-head screws from the fan housing.

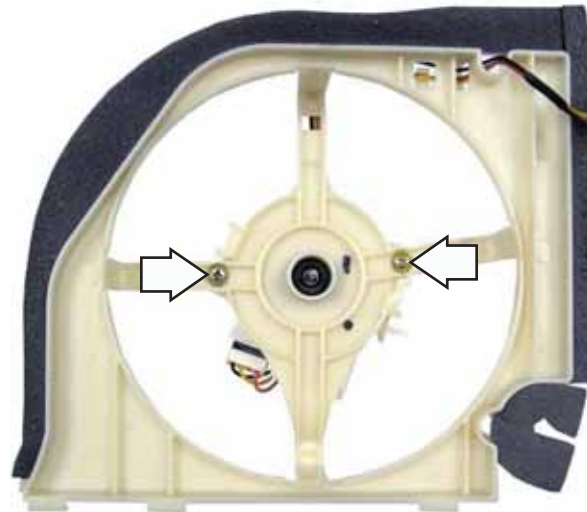

9. Using a flat blade screwdriver or fingertips, lift and spread each of the 2 tabs on the motor clamp and pull the fan motor out of the housing.

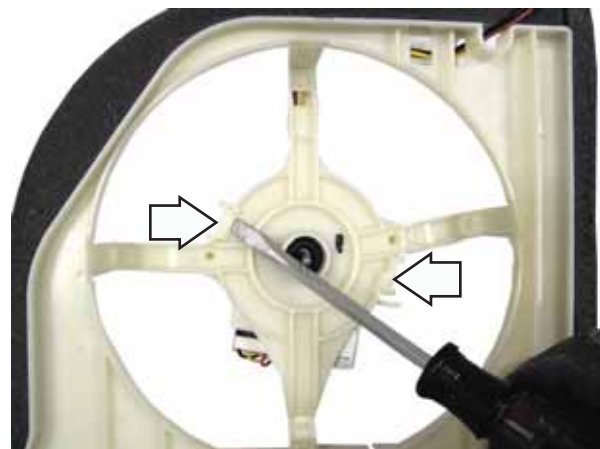

## Thermistors

Thermistor Resistance		
Temperature (°F)	Temperature (°C)	Resistance in Kilo-Ohms
-40	-40	88 kΩ
-31	-35	67.6 kΩ
-22	-30	52.4 kΩ
-13	-25	40.9 kΩ
-4	-20	32.2 kΩ
5	-15	25.6 kΩ
14	-10	20.4 kΩ
23	-5	16.4 kΩ
32	0	13.2 kΩ
41	5	10.8 kΩ
50	10	8.9 kΩ
59	15	7.3 kΩ
68	20	6.1 kΩ
77	25	5 kΩ
86	30	4.2 kΩ
95	35	3.5 kΩ
104	40	3 kΩ
113	45	2.5 kΩ
122	50	2.2 kΩ
131	55	1.9 kΩ
140	60	1.6 kΩ

**Note:** To accurately test a thermistor, place the thermistor in a glass of ice water (approximately 33°F (0.5°C)) for several minutes and check for approximately 12.7K Ω.

## Fresh Food Thermistor

The fresh food thermistor is inserted in a recess located in the top of the fresh food evaporator cover.

To access the thermistor, it is necessary to remove the fresh food evaporator cover. (See *Fresh Food Evaporator Cover*.)

Remove the 4 Phillip-head screws from the fan housing.

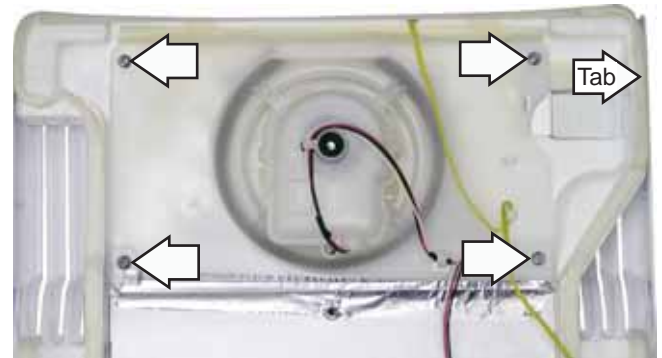

Release the tab at the top corner of the fresh food evaporator cover and separate the cover from the fan housing.

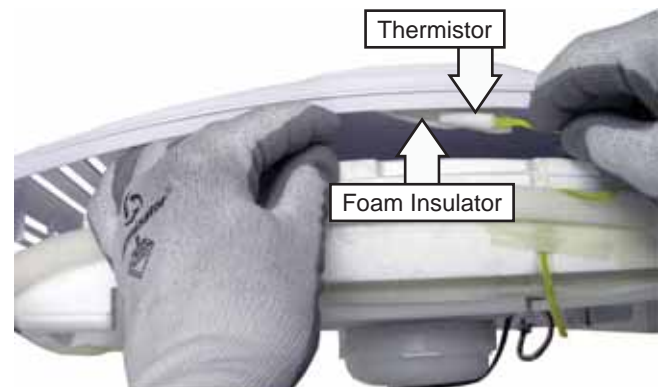

The thermistor recess is covered with a foam insulator that must be peeled back to remove the thermistor.

## Freezer Thermistor

The freezer thermistor is inserted in the thermistor cover located in the ceiling of the freezer compartment behind the light. To access the thermistor, it is necessary to remove the freezer basket and drawer. (See *Freezer Basket and Drawer*.)

To remove the thermistor cover, insert a flat blade screwdriver under the cover and gently pry the cover from the ceiling.

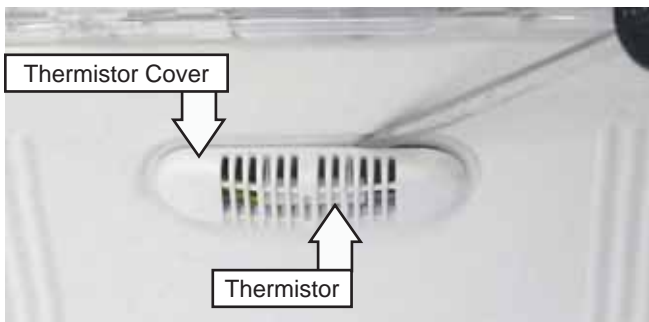

The thermistor is connected to the refrigerator with a wire harness.



## Fresh Food Evaporator Thermistor

To access the fresh food evaporator thermistor, the fresh food evaporator cover must be removed. (See *Fresh Food Evaporator Cover*.) The housing cover can be removed to disconnect the wire harnesses to the thermistor. (See *Fresh Food Evaporator*.)

The fresh food thermistor is located on the evaporator inlet tube.

The thermistor wiring is attached to the evaporator with 2 plastic wire ties and is held to the inlet tube with a plastic clamp. The 2 tabs on the clamp can be pried open to release the thermistor.

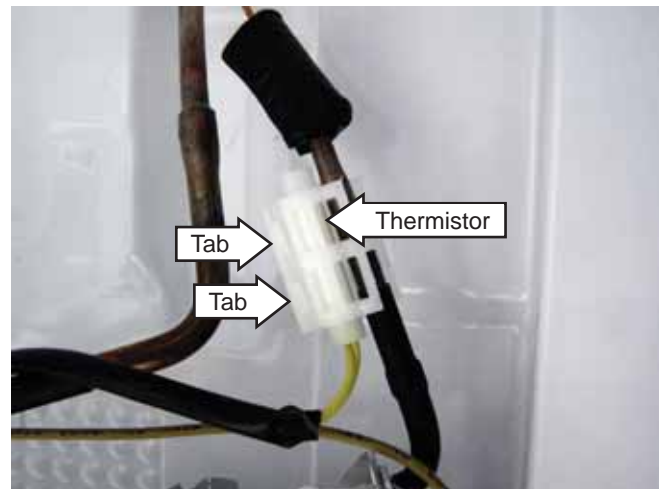



## Freezer Evaporator Thermistor

To access the freezer thermistor, the freezer evaporator cover must be removed. (See *Freezer Evaporator Cover*.) The housing cover can be removed to disconnect the wire harness to the thermistor. (See *Freezer Evaporator*.)

The freezer thermistor is located in a plastic holder attached to the evaporator.

The thermistor holder and the thermistor wiring are attached to the evaporator with 3 plastic wire ties. After the plastic wire ties are removed, the thermistor can be pulled out of the holder.

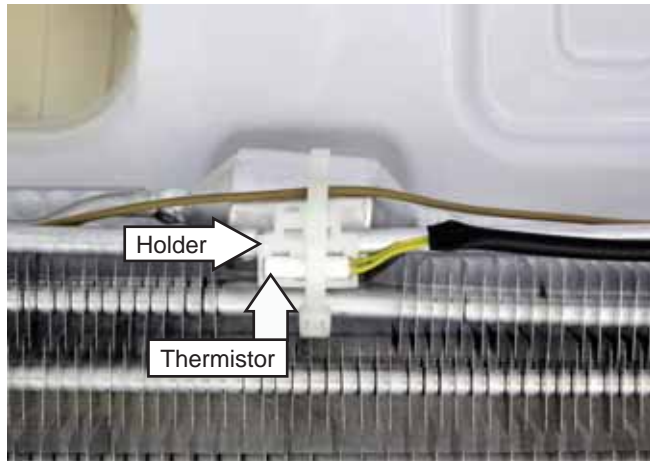

## Ice Room Thermistor

The ice room thermistor is inserted in the auger motor cover. To replace the ice room thermistor the auger motor assembly must be removed. (See *Auger Motor Assembly*.)

The thermistor is connected to the auger motor assembly with a wire harness.

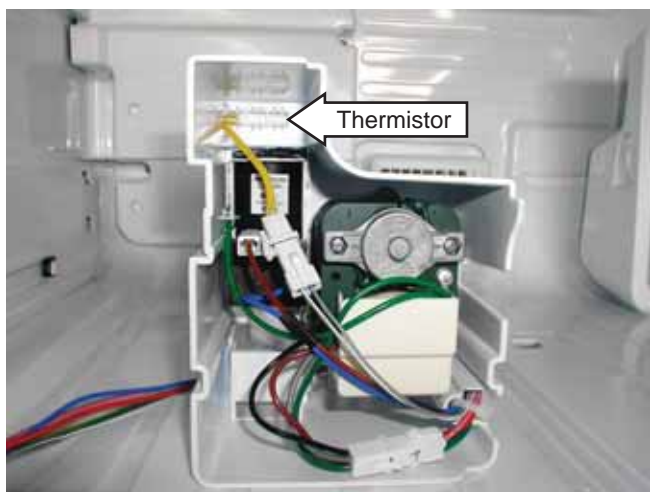

## Pantry Thermistor

The pantry thermistor is inserted in the damper cover.

To replace the pantry thermistor:

1. Remove the damper assembly. (See *Damper Assembly*.)
2. Peel off the foam that seals the damper cover to the back wall of the refrigerator.



3. Carefully pull out the damper assembly from the damper cover.



4. Pull out the pantry thermistor from the damper cover.

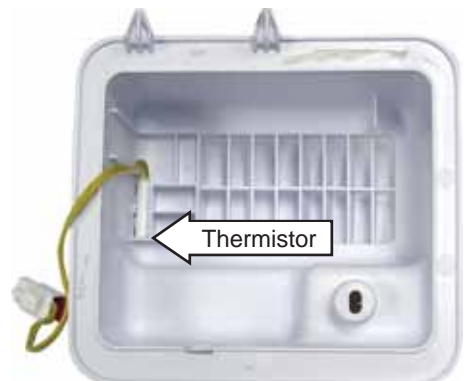

(Continued next page)

## Ambient Thermistor

The ambient thermistor is located under the right side of the top table.

To replace the ambient thermistor:

**Note:** In the following step you do not need to disconnect both reed switch wire harnesses.

1. Remove the top table. (See *Top Table*.)
2. Cut off the thermistor leads where they enter the thermistor body.

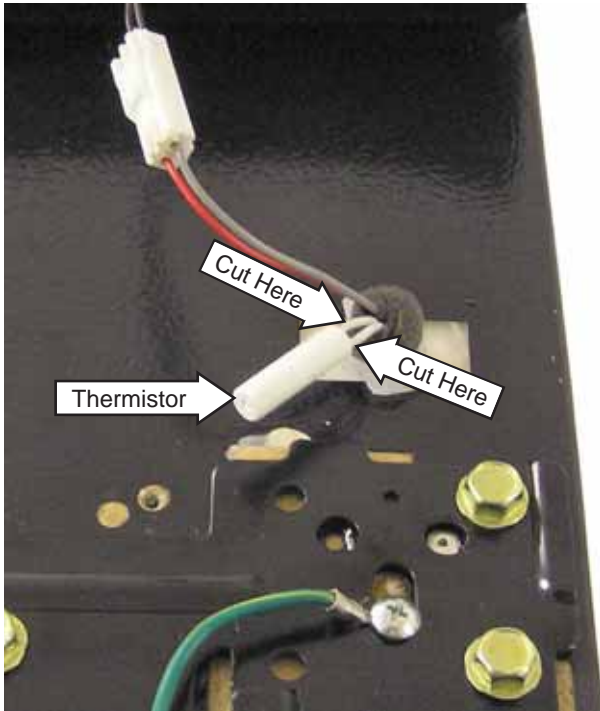

3. Use plastic bell connectors and fill the connector with RTV102 silicone then splice a new thermistor into the wires as shown in the illustration.

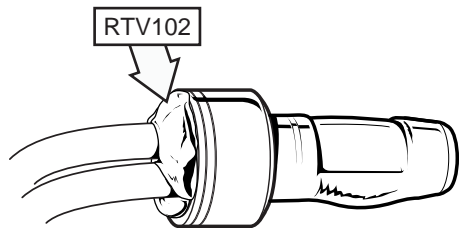

## Over Temperature Thermostats

### Fresh Food Over Temperature Thermostat

The over temperature thermostat is attached on a bracket located on the top left side of the evaporator. (See *Component Locator Views*.)

The thermostat wiring is attached to the evaporator with 2 plastic wire ties and the thermostat is held to the bracket with a metal clip. It is necessary to remove the FF evaporator from the recess to replace the over temperature thermostat. (See *Fresh Food Evaporator*.)

Left Side View of Evaporator

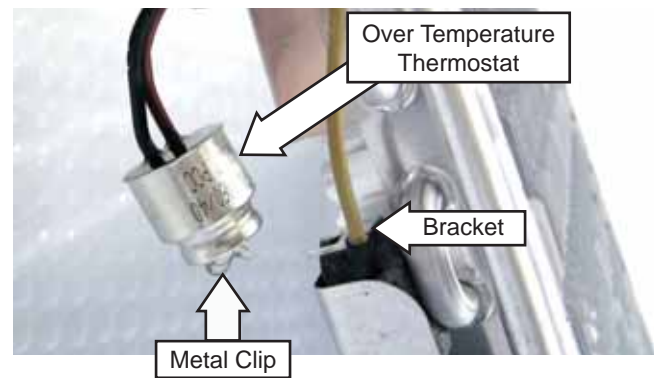

### Freezer Over Temperature Thermostat

The over temperature thermostat is attached on a bracket located on the top right side of the evaporator. (See *Component Locator Views*.) The thermostat wiring is attached to the evaporator with a plastic wire tie and the thermostat is held to the bracket with a metal clip.

Top Right View of Evaporator

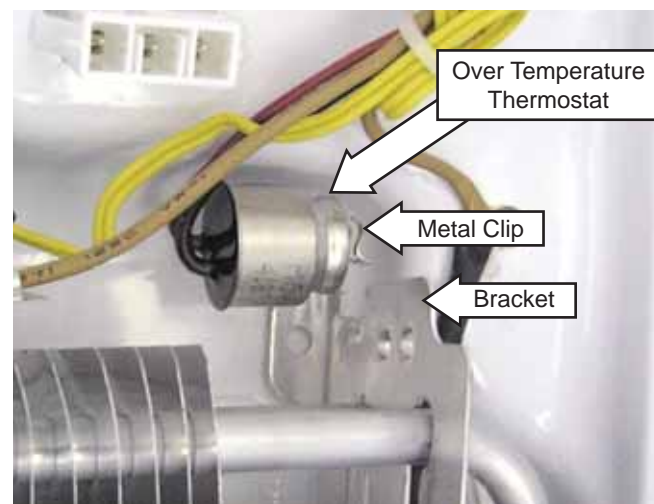

## Defrost Heaters

### Fresh Food Defrost Heater

The defrost heater is located on the sides and bottom of the evaporator.

The defrost heater wiring is attached to the evaporator with 4 plastic wire ties and the heater is held in 2 slots (1 on each side) at the bottom of the evaporator. (See *Fresh Food Evaporator Cover*.)

To remove the defrost heater:

1. Carefully bend open the tabs that form the 2 slots and pull down the heater.
2. Carefully pull the bottom of the evaporator approximately 45 degrees from the recess.

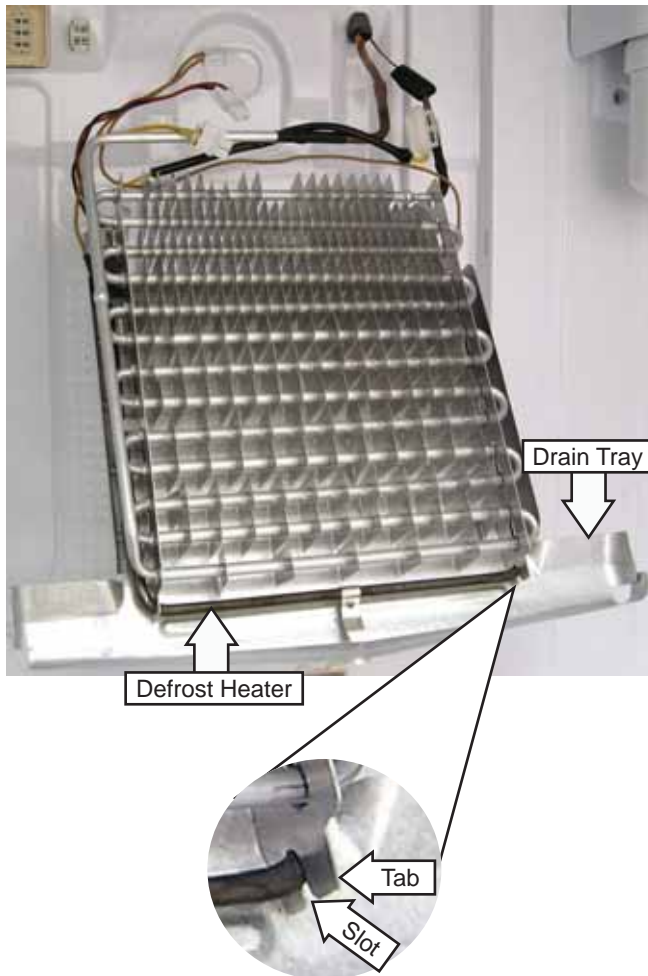

3. Using a small, flat blade screwdriver, reach behind the drain tray and bend straight the 4 lock tabs that hold the evaporator to the drain tray.

Rear View of Drain Tray



4. Separate the drain tray from the evaporator.
  5. Remove the defrost heater from the evaporator.
- Note:** When installing the heater to the drain tray, be sure heat tab is inserted into the drain tray outlet.

## Freezer Defrost Heater

The defrost heater is located on the sides and bottom of the evaporator.

The defrost heater wiring is attached to the evaporator with 4 plastic wire ties and the heater is held in 4 slots) at the bottom of the evaporator. (See *Freezer Evaporator Cover*.)

To remove the defrost heater:

1. Remove the 4 plastic wire ties.
2. Remove the foam air block.

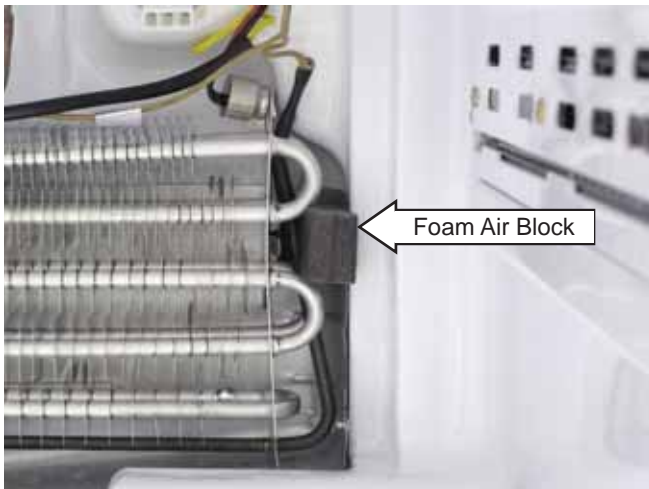

3. Peel off the reflective tape.
4. Carefully bend open the tabs that form the 4 slots and pull down the heater.
5. Carefully pull the evaporator out and up to remove the heat conducting tab from the drain inlet in the recess.

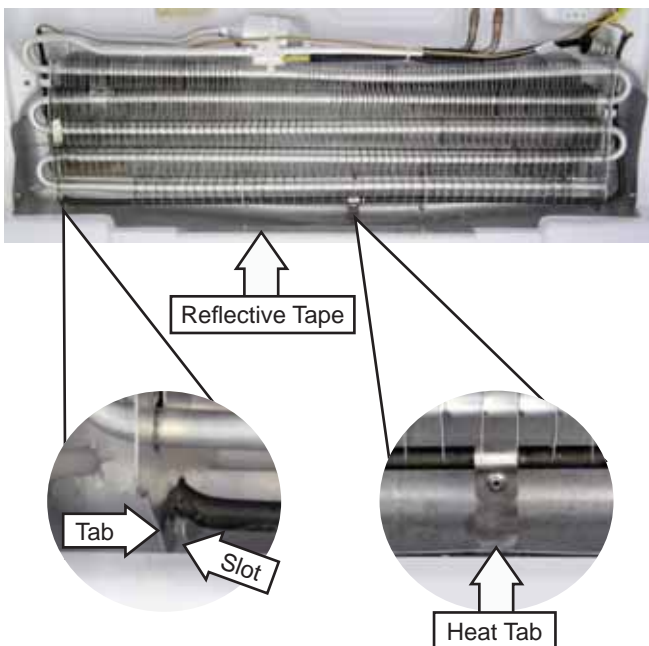

6. Using a small, flat blade screwdriver, reach behind the drain tray and bend straight the 2 lock tabs that hold the evaporator to the drain tray.

Rear View of Drain Tray



7. Separate the drain tray from the evaporator.
8. Remove the defrost heater from the evaporator.

**Note:** When installing the heater to the drain tray, be sure heat tab is inserted into the drain tray outlet.

## Duct Heater

The duct heater is attached to the inside of the freezer evaporator cover. The duct heater prevents water from freezing and blocking air flow to the ice room.

The duct heater is in a parallel circuit with the freezer defrost heater. The heaters are in series with the bimetal defrost safety thermostat. Both heaters operate at 120 VAC when the freezer defrost circuit is energized by the main control board and the defrost safety thermostat is closed.

(Continued next page)



The heater can be checked directly as a separate component by removing the freezer evaporator cover (See *Freezer Evaporator Cover*.) The heater wire harness can then be disconnected.

The duct heater has a resistance value of approximately 3.18K  $\Omega$ .



To remove the duct heater:

1. Remove the freezer evaporator cover (See *Freezer Evaporator Cover*.) and place the cover assembly on a protected surface so that the inside faces upward.
2. Note the positioning of the wiring and untape the wire harnesses.
3. Remove the 2 plastic wire ties (not shown) and the duct heater wires from all retainers.

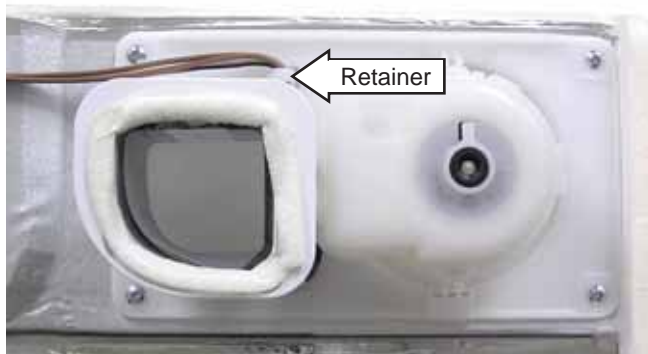

4. Press the top and bottom tabs inward and pull the duct assembly from the ice room blower housing.

Top View of Duct

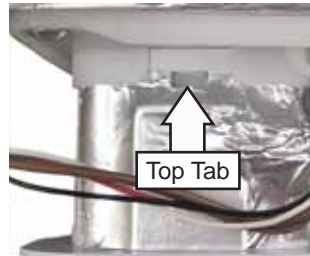

Bottom View of Duct



### EMI Filter and Power Cord

It is necessary to remove the EMI filter to replace the power cord. The power cord is connected to the EMI filter with a wire harness.

To remove the EMI filter and power cord:

1. Remove the machine compartment cover. (See *Machine Compartment Cover*.)
2. Remove the Phillips-head screws that hold the EMI filter bracket, water valve, power cord, and ground wires to the cabinet.
3. Disconnect the EMI filter wire harness.

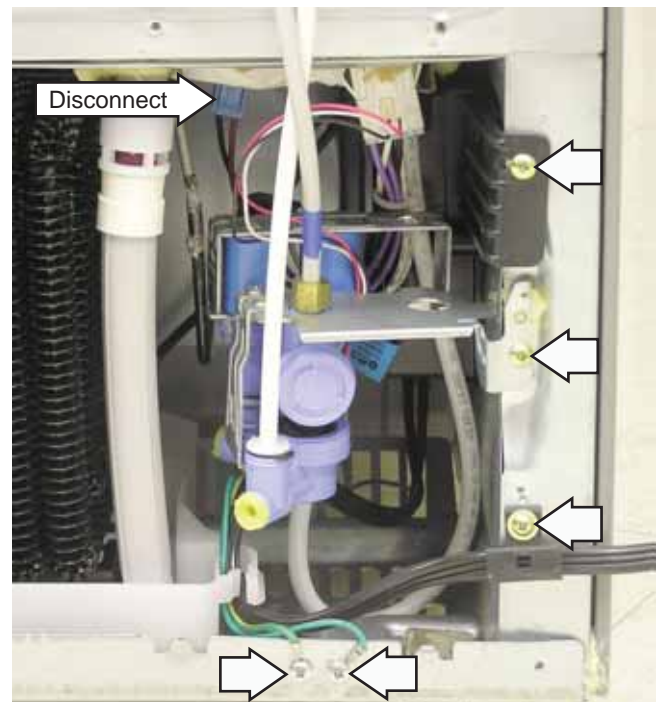

4. Position the water valve to the left side.
5. Pull the EMI filter bracket straight out.
6. Remove the Phillips-head screw and open the bracket.



7. Disconnect the power cord wire harness.
8. Using a flat screwdriver, press the 2 tabs and remove the EMI filter.

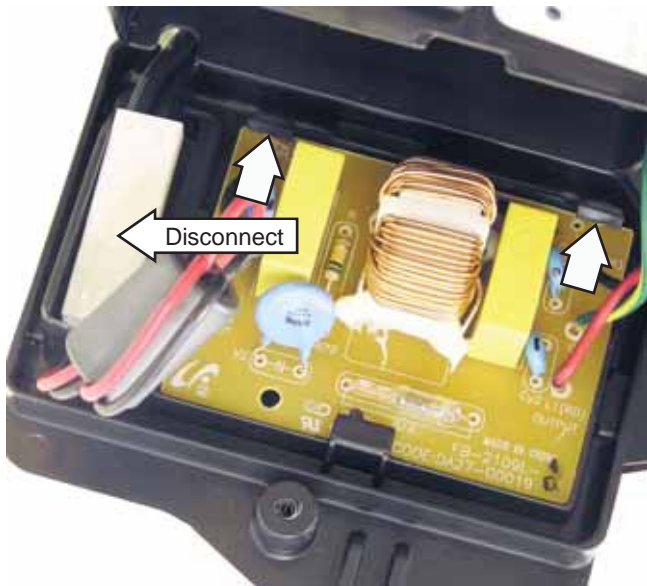

## Circuit Boards

The compressor inverter and main control boards are installed in a recess located in the back of the refrigerator. The recess is concealed by a cover that is attached with 2 tabs at the bottom (not visible) and 2 Phillips-head screws at the top.

To access the boards, it is necessary to remove the 2 Phillips-head screws then lift the cover from the back of the refrigerator.



## Inverter Board

**WARNING:** When the refrigerator is plugged in, 120 VAC is always present at the inverter.

The inverter board is positioned behind 2 tabs at the top and attached with a lock tab at the bottom. The board is connected to the refrigerator with 3 wire harnesses. To remove the board, disconnect the wire harnesses, and push down the lock tab.

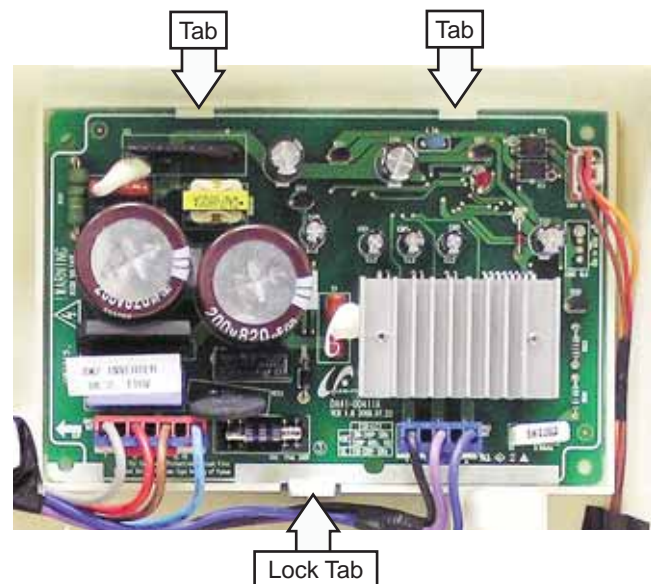

(Continued next page)

**Note:** Certain voltmeters will not be able to read voltage output from the inverter.

The inverter receives 120 VAC line-in from the power supply. The inverter converts this single-phase, 60 Hz, 120 VAC into 3-phase, 230 VAC, with frequency variations between 400 Hz and 700 Hz. This voltage is delivered to the compressor through 3 lead wires. Each wire will carry identical voltage and frequency.

**Note:** If the compressor wires are not connected, or if an open occurs in one of the 3 lead wires or in the compressor, the inverter will stop voltage output.

The inverter controls compressor speed by frequency variation and by Pulse Width Modulation (PWM). Changing frequency and PWM will cause an effective voltage between 80 and 230 VAC to be received at the compressor.

- Low speed (1710 rpm) - 400 Hz
- Medium speed (2100 rpm) - 500 Hz
- High speed (3120 rpm) - 700 Hz

The inverter receives commands from the main control board. The main control board will send a PWM run signal from the J15 connector of between 4-6 VDC effective voltage to the inverter (all wires must be connected). The inverter will select compressor speed (voltage output) based on this signal.

The main control board will only send a run signal to the inverter when the compressor should be on.

**Note:** When measuring signal voltage (from the main control board) at the inverter, a reading of approximately 2.9 VDC will be measured with all wires connected. If the inverter wiring is disconnected, the board output will measure between 10-12 VDC.

The inverter will monitor compressor operation and if the compressor fails to start or excessive current draw (4 amps maximum) is detected, the inverter will briefly stop voltage output. The inverter will then make 12 consecutive compressor start attempts (once every 12 seconds). After 12 attempts, if the compressor has not started, an 8-minute count will initiate. After the 8-minute count, the inverter will attempt to start the compressor again. If the compressor starts, normal operation will resume. If the compressor fails to start, this process will be

repeated. Removing power to the unit will reset the inverter count. When power is restored, the inverter will attempt to start the compressor within approximately 8 minutes.

The inverter has a built-in circuit protection to guard against damage from a failed or shorted compressor. However, if a failed compressor is diagnosed, order a new compressor and inverter. If the compressor fails to start after replacement, replace the inverter.

## Main Control Board

The main control board is positioned behind 2 tabs at the bottom and attached to the recess with a lock tab at the top. The board is connected to the refrigerator with 15 wire harnesses. To remove the board, unplug the refrigerator, disconnect the wire harnesses, and push the lock tab.





## Inverter Compressor

**Caution:** Do not attempt to direct-start the compressor. The compressor operates on a 3-phase power supply. Applying 120 VAC to the compressor will permanently damage the unit. It is not possible to start the compressor without an inverter.

The compressor is a reciprocating, multi-speed, 4-pole type. It operates on 3-phase, 80 to 240 VAC within a range of 400 to 700 Hz.

**Note:** Certain voltmeters will not be able to read voltage output or frequency from the inverter.

Compressor wattages at various speeds are:

- LOW - 65 watts
- MED - 100 watts
- HIGH - 150 watts

The compressor is controlled by the inverter board, located in the main board compartment. The inverter board receives its signal from the main control board. Varying the frequency to the inverter changes the compressor speed.

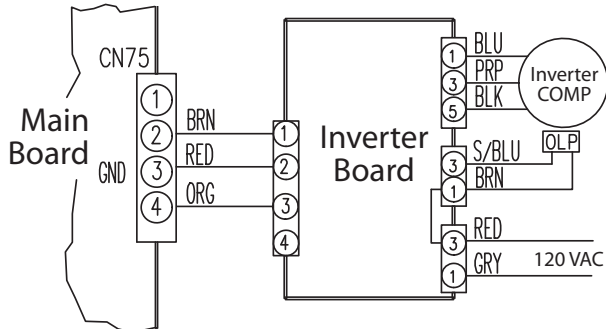

Compressor speed is based on the temperature set point in conjunction with the specific cabinet temperature. Speeds are selected according to the following cabinet temperatures, with freezer temperature being the primary:

- 7°F to 19.5°F above freezer set point = high speed.
- 4.5°F to 6.5°F above freezer set point = medium speed.
- 1°F to 4°F above freezer set point = low speed.
- 1°F to 2.5°F above refrigerator set point = low speed.

- 3°F to 5°F above refrigerator set point - medium speed.
- 5.5°F to 7°F above refrigerator set point - high speed.

**Note:** The compressor will run at medium speed if the freezer temperature is 20°F or more above the setpoint.

The use of 3-phase power eliminates the need for the relay, capacitor, and individual start and run windings; therefore, the start, run, and common pins found on conventional compressors are not applicable on this 3-phase model. Compressor pin functions are identical and compressor lead wire configuration is of no importance. A resistance of 9 Ω to 11 Ω should be read between any 2 of the 3 pins. Should an opening occur in the compressor winding or should one of the compressor lead wires become open or disconnected, the inverter will stop voltage output to the compressor.

Compressor operation is extremely smooth and cool. The compressor exterior may be slightly higher than room temperature while operating; therefore, it may be difficult to detect a running unit.

**To verify that the compressor is running:**

Disconnect power from the unit and place a hand on the compressor. Reconnect power and feel for a vibration when the compressor tries to start. It may take up to 8 seconds before the compressor attempts to start.

**Note:**

- When ordering a replacement compressor, order both the compressor and inverter. Replace the compressor first. If, after compressor installation, the compressor fails to start, replace the inverter.
- When servicing the compressor, it is important to dress the wiring to keep low voltage DC wiring and 120 VAC wiring separate.



## 3-Way Valve

The 3-way valve is composed of a magnetic coil and a valve body and is located to the left of the compressor in the machine compartment. It is accessed from the back of the refrigerator. One Phillips-head screw mounts the valve to the cabinet.



There are three copper tubes connected to the 3-way valve. One jumper tube connects from the drier to the inlet on the valve. A freezer capillary and a fresh food capillary connect to the other two tubes on the valve.

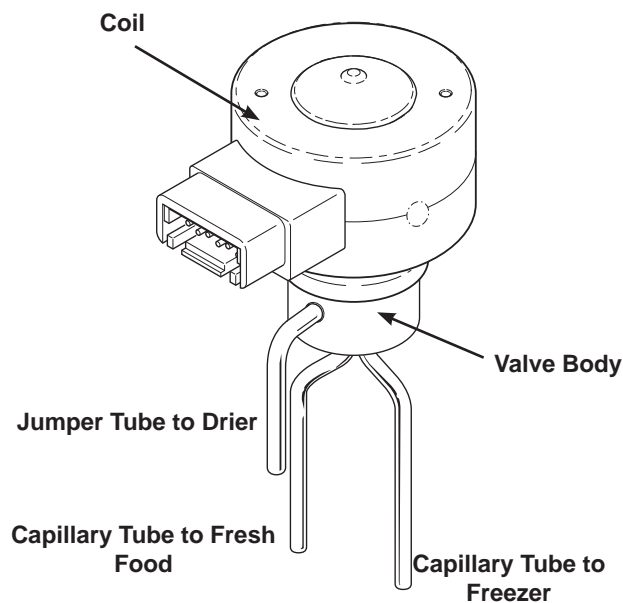

## Testing the 3-Way Valve

The valve returns to “home” at the end of every freezer defrost cycle and whenever the refrigerator is reconnected to power.

To test the valve, disconnect the refrigerator from power for at least 10 seconds, place a finger on top of the valve, and reconnect power.

The main control overdrives the valve to the “home” position.

You should be able to feel the valve vibrate as the coil moves the magnet to the home position .

If movement is present, the main board and valve coil are operating correctly.

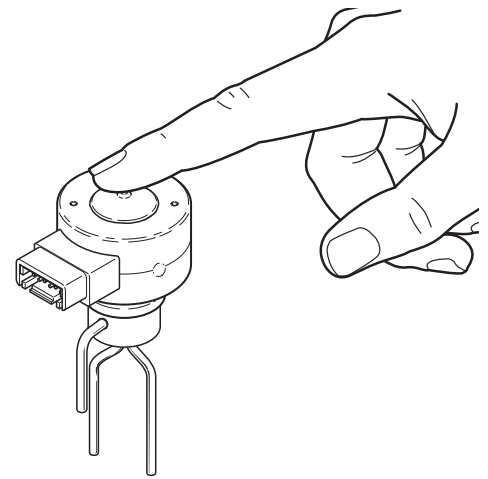

## 3-Way Valve Coil

The 3-way valve coil receives 12-VDC pulses from the main board to change the position of the valve. The pulses come too quickly to measure with a volt meter.

The 3-way valve coil has a resistance value of approximately 40 ohms that can be measured between the coil pins.

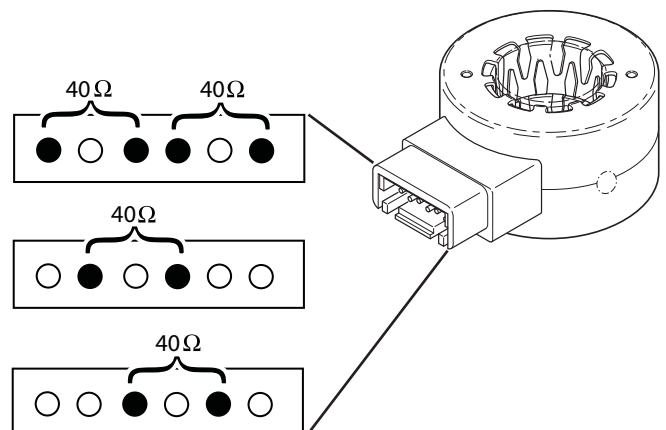

## Replacing the 3-Way Valve Coil

To replace the 3-way valve coil:

1. Unplug the refrigerator.
2. Remove the rear access cover.
3. Remove the Phillips-head screw securing the 3-way valve to the cabinet.
4. Remove the valve coil from the valve body by carefully prying each of the 2 locking tabs out and pulling up on the coil.



5. Disconnect the wire harness from the coil.

## Replacing the 3-Way Valve

**Note:** When replacing a 3-way valve, note the black mark on the freezer outlet tube. Make certain to mark the freezer capillary by placing a piece of tape on the capillary, 6-8 inches from the valve. This will aid in installing the capillaries in the correct outlet tubes.

To replace the 3-way valve:

1. 1. Remove the 3-way valve coil. (See *Replacing the 3-Way Valve Coil*.)
2. Evacuate the sealed system. (See *Evacuation and Charging Procedure*.)
3. Tape the freezer capillary tube 6 inches below the brazing joint. Score and break the 2 capillary tubes below the brazing joints.

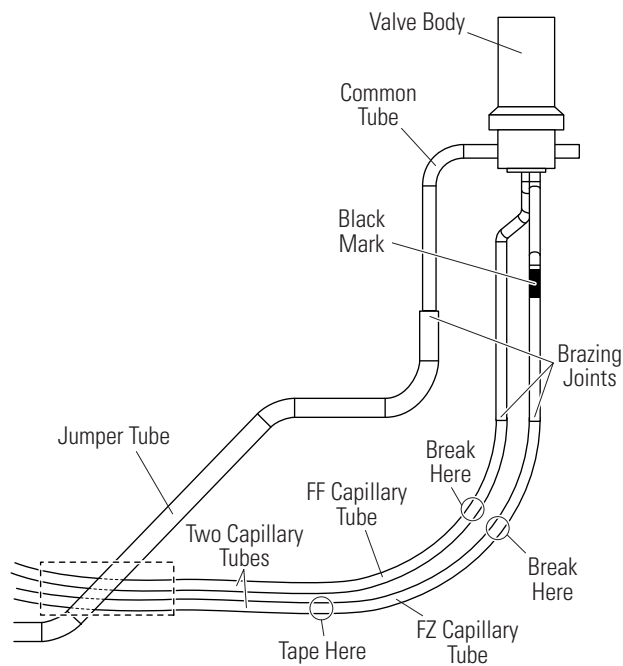

4. Connect the new jumper tube to the inlet tube of the new 3-way valve.
5. Prepare the taped capillary tube, and insert it into the 3-way valve freezer outlet port (identified with black mark or tape).

6. Prepare the remaining capillary tube and insert it into the 3-way valve fresh food outlet port.

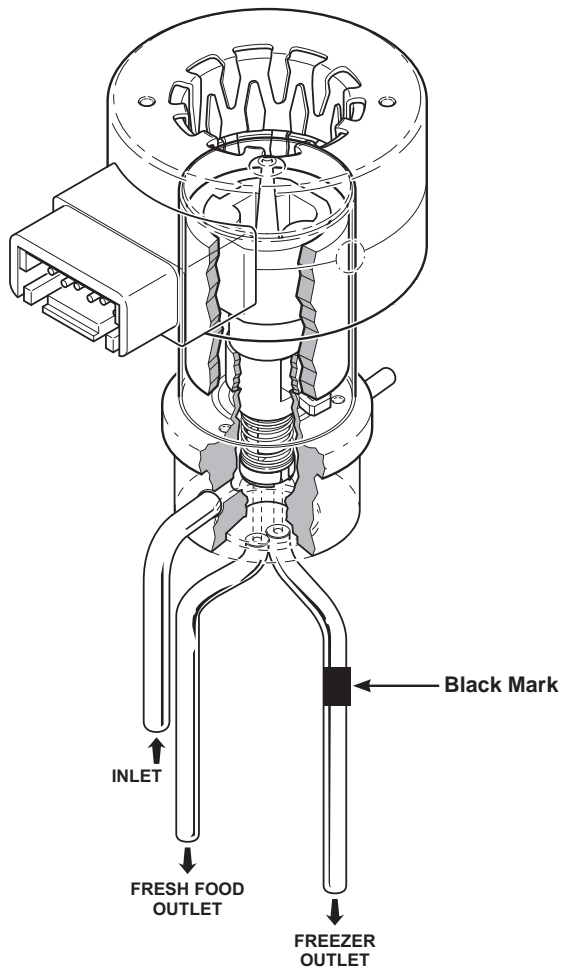

7. Apply a liberal amount of thermal paste to the base of the three tubes on the new valve. Apply a wet cloth to the top of the valve to help keep the valve cool.

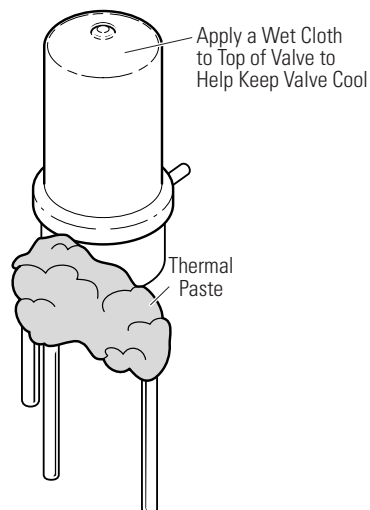

8. Angle the torch so the flame is not directed towards the valve body when brazing the three joints.
9. Remove the thermal paste residue and dry the valve body thoroughly. Install the coil on to the valve body.
10. Remove the old drier by unbrazing or cutting the condenser loop (halo) as close as possible to the drier. Install the new drier assembly (part # WR86X93).

**Note:** If necessary, use the condenser loop extension tubing (part # WR97X238).

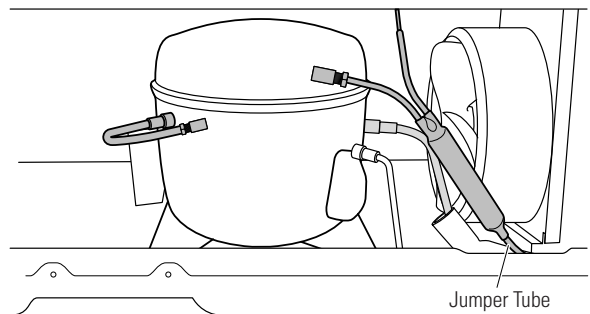

11. Install the process valve (part # WJ56X61). Clean and inspect all joints.
12. Evacuate and charge the system. Use original factory charge quantity of R-134a. (See *Evacuation and Charging Procedure.*)
14. Reinstall the rear access cover.

## Dispenser Display Assembly

**Note:** This section will address how to remove the LCD dispenser display. The procedure to remove the LED dispenser display is similar.

The dispenser display assembly incorporates the interface used for temperature control and features. The assembly also houses the dispenser LED lights. The display has 5 tabs that hold it to the dispenser recess.

Tab Locations

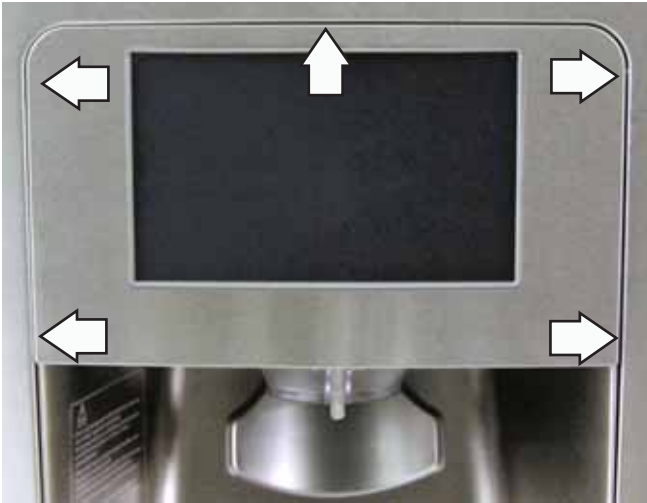

To remove the dispenser display:

1. Remove the Phillips-head screw from the housing.



2. Use a small screwdriver and pry out on the slot shown in the photo below.



3. Grasp the bottom of the display, pull it out, and remove it from the recess.



4. Disconnect the wire harness.

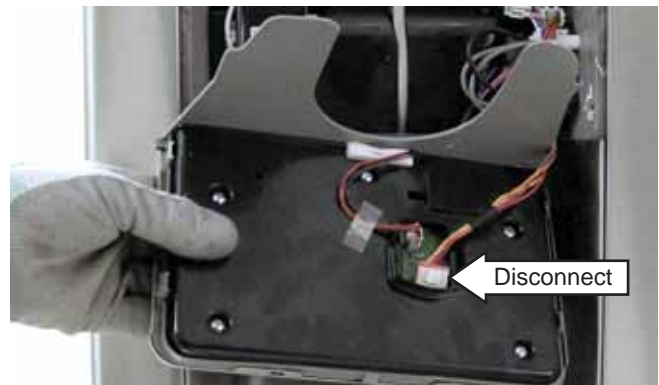

**Caution:** To prevent breaking tabs when installing the display, first insert the top and right side tabs into the recess then snap the display in place.

## Dispenser Assembly

The dispenser assembly includes the duct door, duct door motor, cam and cam switches, and funnel. The assembly is held to the dispenser recess with 2 screws and 1 tab.

To replace the dispenser assembly:

1. Remove the dispenser display assembly. (See *Dispenser Display Assembly*.)
2. Disconnect the motor and cam switches wire harnesses.

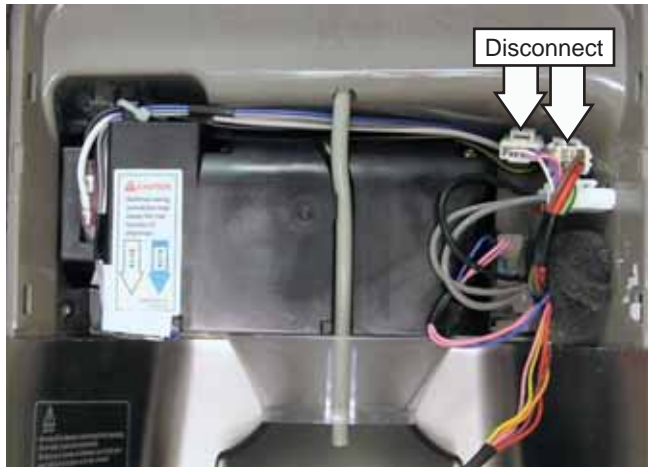

3. Unsnap the water line from the channel and pull the line out from the guide in the funnel.
4. Remove the 2 Phillips-head screws. Lower the assembly down to disengage the tab. Pull the dispenser assembly from the recess.

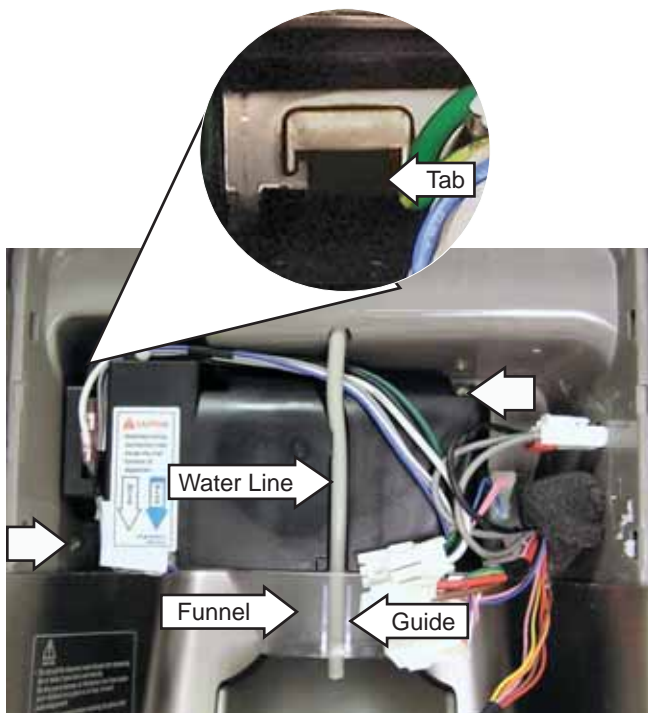

**Caution:** Wiring is firmly attached to the cradle switch. To prevent breaking mounting pins, care must be taken when removing wiring.

5. Carefully disconnect the cradle switch wiring.



**Note:** When installing the dispenser assembly, ensure the water line is snapped into the channel and inserted into the guide in the funnel and the tab is engaged in the recess.



The duct door motor rotates an eccentrically shaped plastic cam which operates the duct door. The cam operates 2 route switches attached to the dispenser assembly. The switches inform the main board the position of the duct door so the auger and/or cube solenoid can be activated. If communication is lost between the switches and the board, for example because of a switch failure, the symptom usually will be continuous operation of the duct door.

The duct door motor operates at 120 VAC when energized by the main control board.

The motor has resistance value of approximately 1.73K  $\Omega$ . Check for the approximate resistance value of the motor on the main board from CN70 pin 9 to CN74 pin 9.

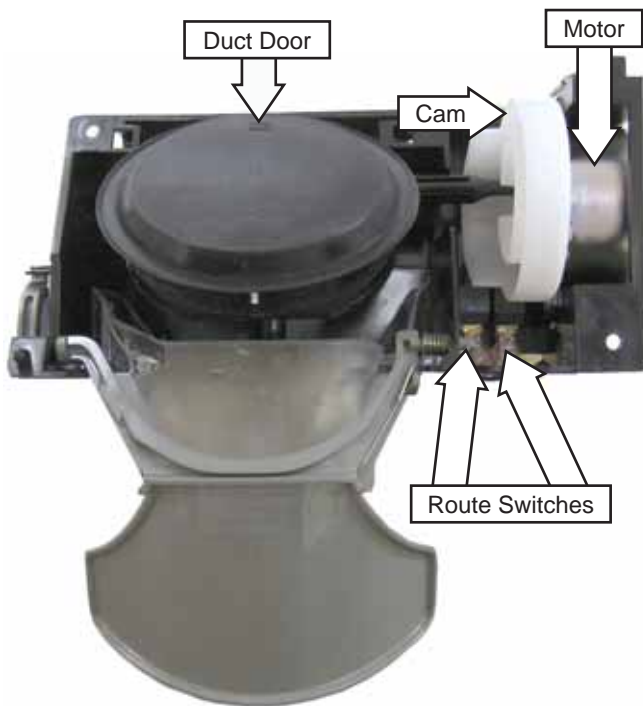

### Dispenser Heater

The dispenser heater ensures that the dispensing recess does not sweat in high humidity. The dispenser heater operates at 120 VAC when energized by the main control board.

The heater has resistance value of approximately 4.4K  $\Omega$ . Check for the approximate resistance value of the heater on the main board from CN70 pin 3 to CN1 pin 3.

**Note:** The dispenser heater is integral to the foamed in place dispenser recess in the left-side refrigerator door and is not replaceable.

### Vegetable and Fruit Drawers Shelf

To remove the vegetable and fruit drawers shelf:

1. Pull the 2 fruit and vegetable drawers out to the stop position. Lift and remove the drawers.
2. Lift and pull out the shelf.

### Pantry Drawer Assembly

To remove the pantry drawer assembly:

1. Pull the 2 fruit and vegetable drawers out to the stop position. Lift and remove the drawers.
2. Pull the pantry drawer out to the stop position. Lift and remove the drawer.
3. Carefully lift the center of the drawer cover up while pushing the cover to the left. When the right side hinge pin has disengaged from the hole in the rail assembly, slide the right side of the cover out.

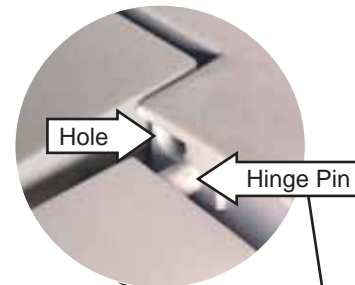

4. Lift and pull out the drawer cover.
5. Lift the front of the pantry shelf and pull it out of the refrigerator.

## Pantry Drawer Control

To remove the pantry drawer control:

1. Remove the pantry drawer assembly. (See *Pantry Drawer Assembly*.)
2. Remove the 3 Phillips-head screws that attach each rail.

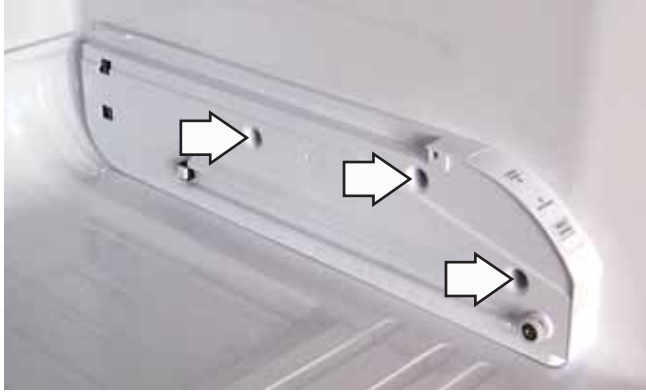

3. Pull the rail towards the front of the refrigerator.
4. Disconnect the wire harness from the right side rail.
5. Remove the Phillips-head screw that attaches the control to the rail.

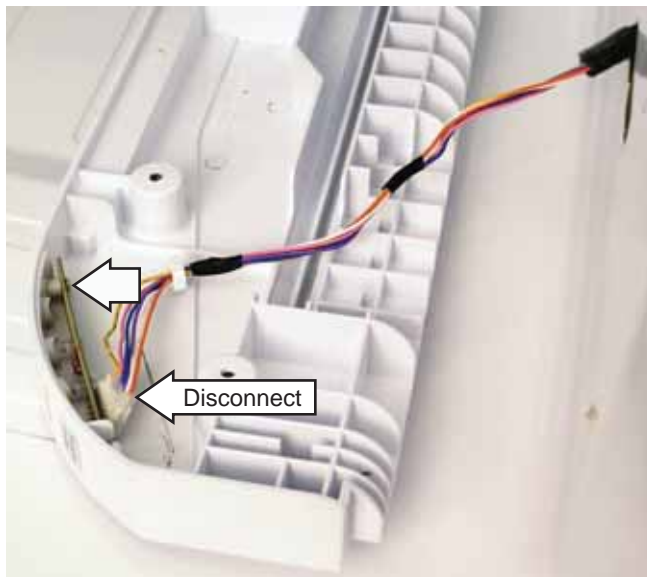

## Damper Assembly

The damper assembly is held to the back wall of the refrigerator with a Phillips-head screw and 2 tabs.

To remove the damper motor:

1. Remove the pantry drawer. (See *Pantry Drawer Assembly*, follow steps 1 and 2.)
2. Remove the recessed Phillips-head screw from the damper cover.



3. Pull the bottom of the damper cover out and down from the back wall of the refrigerator.
4. Disconnect the 2 wire harnesses.

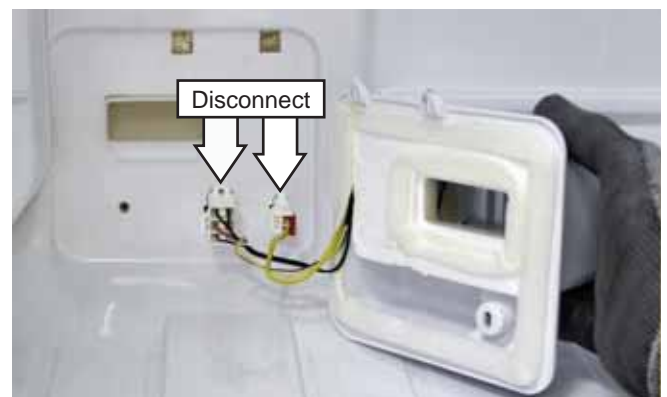

## Water Tank

To remove the water tank:

1. Remove the vegetable and fruit drawers shelf. (See *Vegetable and Fruit Drawers Shelf*.)
2. Remove the pantry drawer. (See *Pantry Drawer*.)
3. Remove the 2 Phillips-head screws that attach the water tank assembly to the back wall of the refrigerator section.

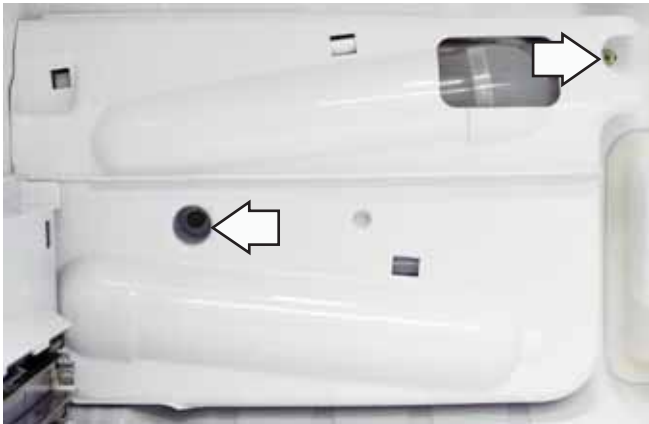

4. Carefully pull the right side of the tank assembly approximately 5 inches out from the back wall.
5. Disconnect the water tank heater wire harness.

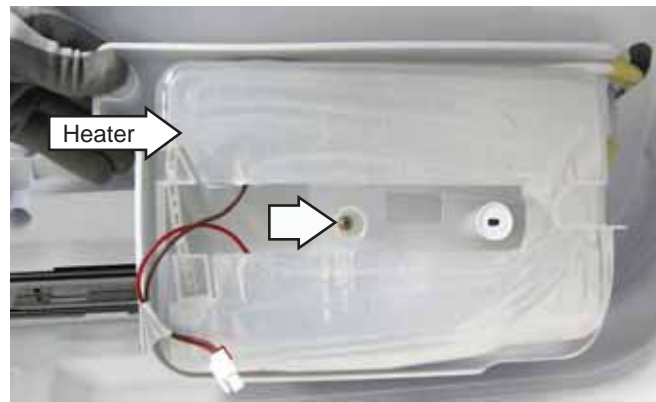

### Note:

- The water tank heater is 13 VDC and only turns on when the fresh food thermistor reads below 35°F. The tank heater resistance is 72  $\Omega$  and can be read from the main board CN79 pin 2 to pin 6, or at the water tank heater wire harness.
  - The water tank heater is attached to the tank cover with a recessed Phillips-head screw.
6. Remove the Phillips-head screw that attaches the water tank heater to the cover.
  7. Note the routing of the tank inlet, connector, and outlet tubes. Remove the tubing and tanks from the cover.



8. Remove the John Guest clip from each coupler. Push in the rear collar on the water coupling and pull out the water tube.

**Note:** The tank inlet and outlet tubes are routed through separate conduits placed inside the cabinet wall.

To remove the water valve assembly:

1. Remove the machine compartment cover. (See *Machine Compartment Cover*.)
2. Remove the icemaker inlet tube.
3. Remove the 1/2-in. hex nut from the water supply tube. Pull out the tube from the icemaker valve assembly.
4. Disconnect the flow meter wire harness.
5. Remove the Phillips-head screw that holds the water valve in place. Pull the valve assembly straight out.

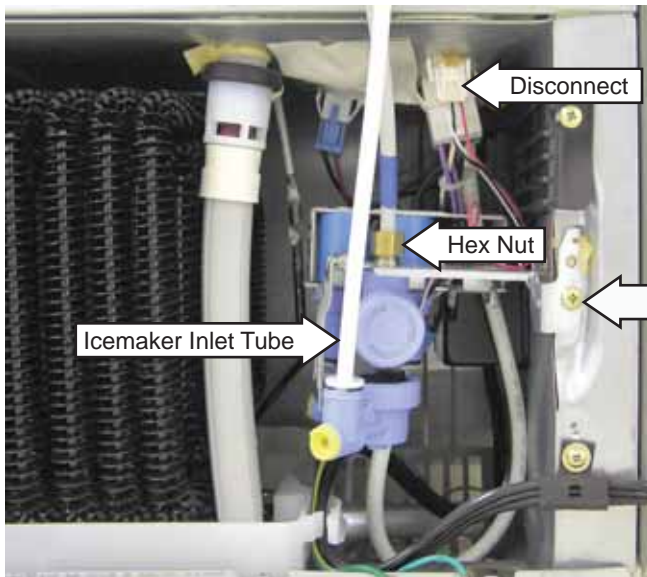

To remove the flow meter:

1. Remove the water valve assembly. (See *Water Valve Assembly*.)
2. Remove the 4 Phillips-head screws and the bracket from the water valve.
3. Remove the John Guest clip. Pull the flow meter from the water valve.

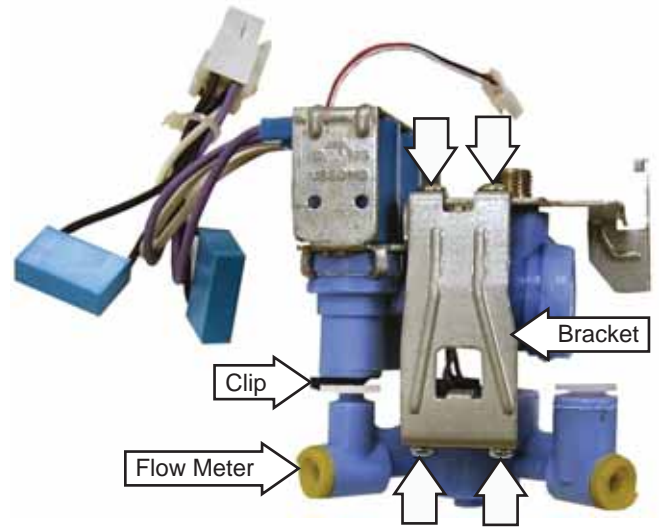

6. Disconnect the water valve wire harness.
7. Remove the dispenser tank water inlet tube from the water valve assembly.

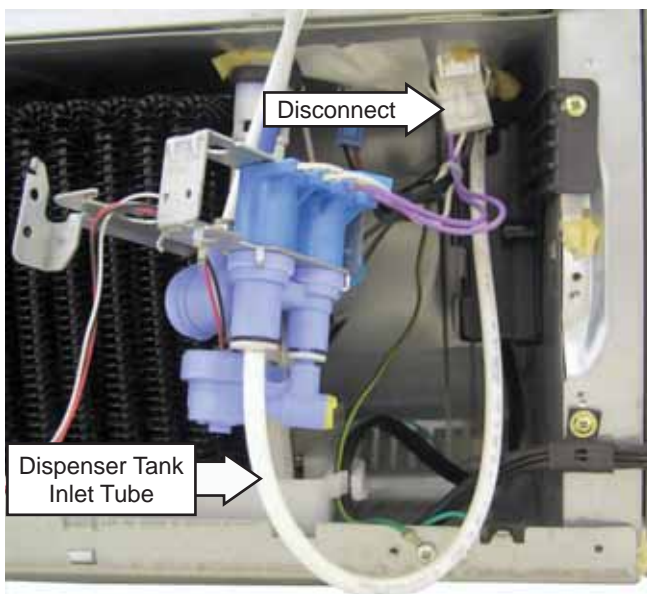

## Ice Bucket and Icemaker

### Ice Bucket

The bucket can be removed by pulling the release lever towards the front of the refrigerator and sliding the bucket out.



### Icemaker

Under normal operating conditions, the icemaker is capable of producing approximately 100-130 cubes (approximately 4.3 pounds of ice) in a 24-hour period. The rate of ice production depends on freezer compartment temperature, room temperature, number of door/drawer openings, and other use conditions.

To activate the icemaker cycle, press and hold the start button approximately 3 seconds.

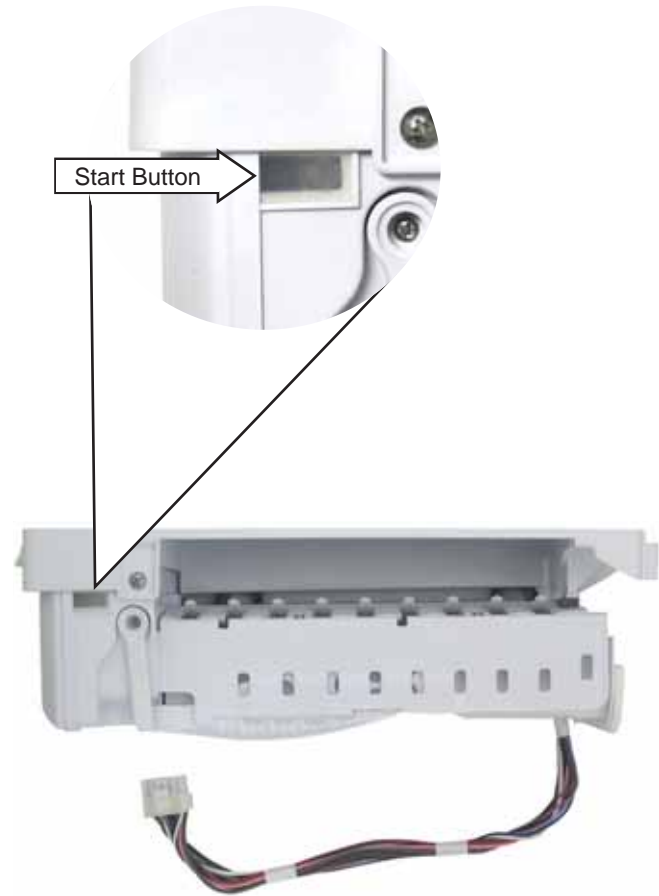

The icemaker is attached to the ceiling of the ice room by 2 key tabs.



To remove the icemaker:

1. Remove the Ice bucket. (See *Ice Bucket*.)
2. Remove the Phillips-head screw that attaches the front of the wire harness cover.



3. Using a small, flat blade screwdriver, pry the front of the cover out. Pull the cover towards the front of the refrigerator.



4. Note the routing of the icemaker wire harness and then disconnect the harness.

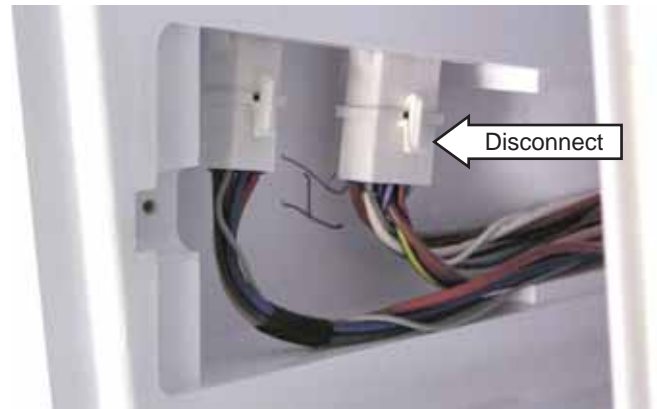

5. Push in the release tab on the front of the icemaker. Pull the icemaker out of the ice room.



**Note:** When installing icemaker, engage key slots in key tabs before pushing icemaker in place.

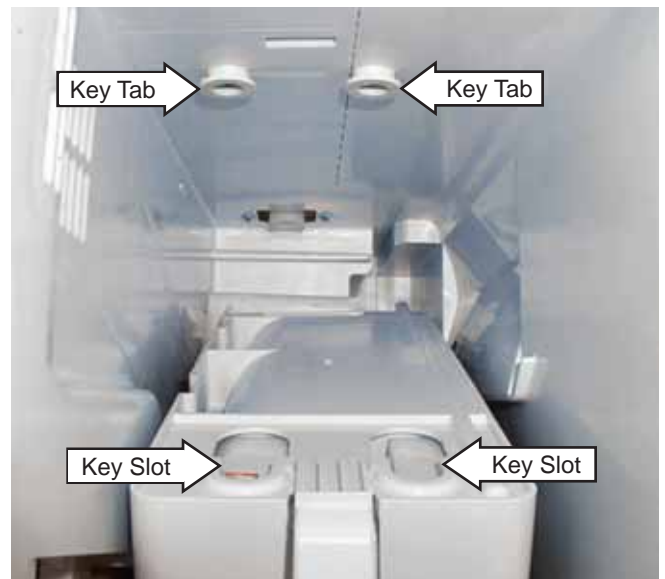

## Auger Motor Assembly

To remove the auger motor assembly:

1. Remove the ice bucket and icemaker. (See *Ice Bucket and Icemaker*.)
2. Note the routing of the auger motor assembly wire harness and then disconnect the harness.

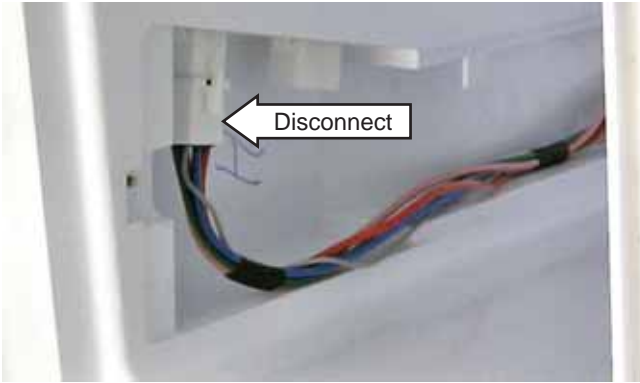

3. Push the release tab on the front of the auger motor assembly to the right. Pull the auger motor assembly out of the ice room.

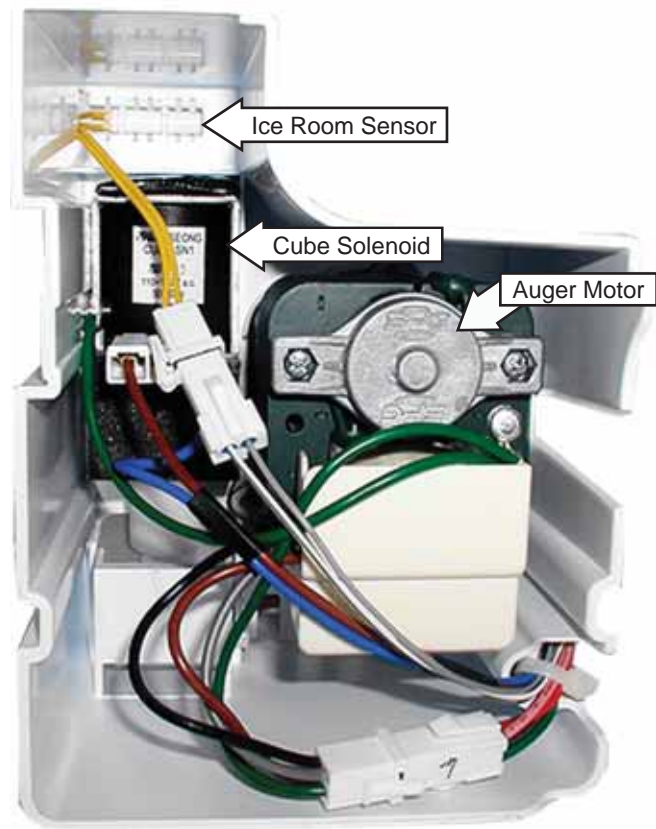

Auger Assembly Components

## Fresh Food Door Switch

**Note:** On early production models, the black wire is not connected to any circuit. It was added to protect the exposed unused terminal.

On later production models, the separate wiring will be changed to a plug-in harness and the black wire will be removed.

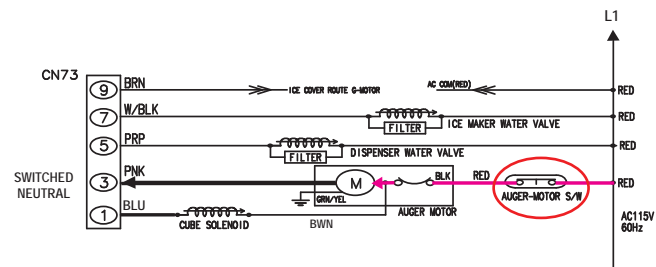

## Articulating Door Mullion

The articulating door mullion is attached to the left side door and provides a movable center mullion that maximizes access to the fresh food compartment. With both refrigerator doors closed or only the right side door opened, the mullion stays in position. When the left side door is opened, the spring-loaded mullion is activated to fold against the handle side of the door liner.

The pin on top of the mullion and the track, located at the top center front of the refrigerator, ensures proper mullion bar alignment upon closure of the left side door.

The articulating door mullion consists of the mullion, heater (French Heater), external spring, and 3 hinges.

**Note:** If the Energy Saver indicator light is lit, then the articulating door mullion heater is disabled.

The heater operates on 120 VAC with the doors open or closed. The resistance of the heater is approximately 1.3K  $\Omega$ . Check for the correct voltage and resistance on the main board at CN71 pin 5 to CN1 pin 3.

**To remove the articulating door mullion assembly:**

1. Using a small, flat blade screwdriver, pry off the 2 screw caps.

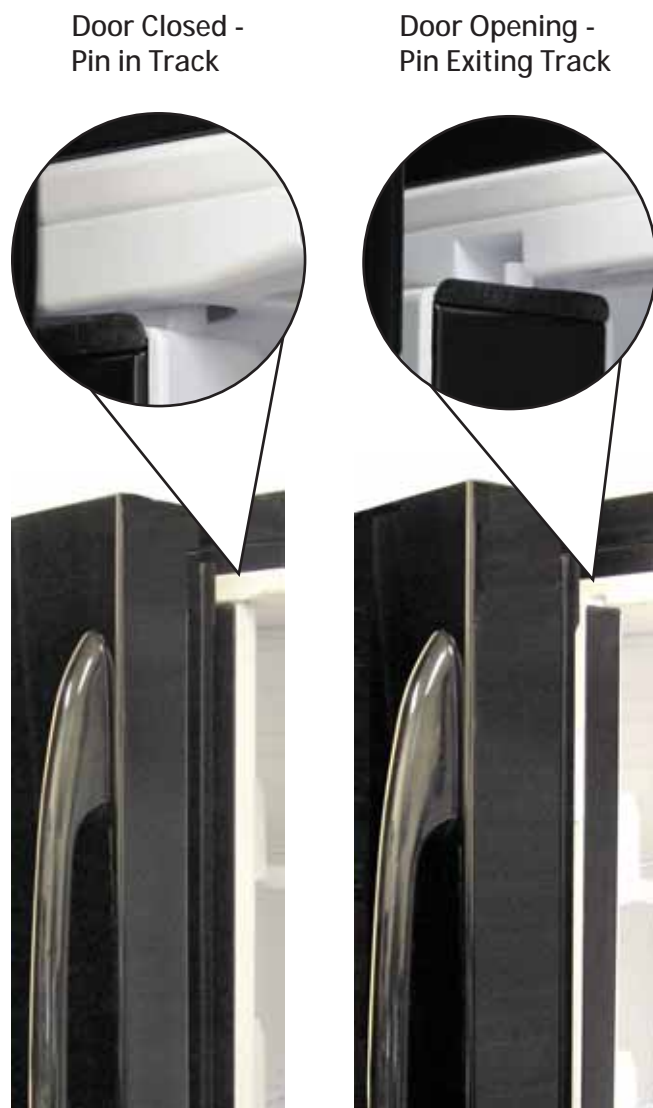

2. Remove the 2 Phillips-head screws from the wire harness cover.

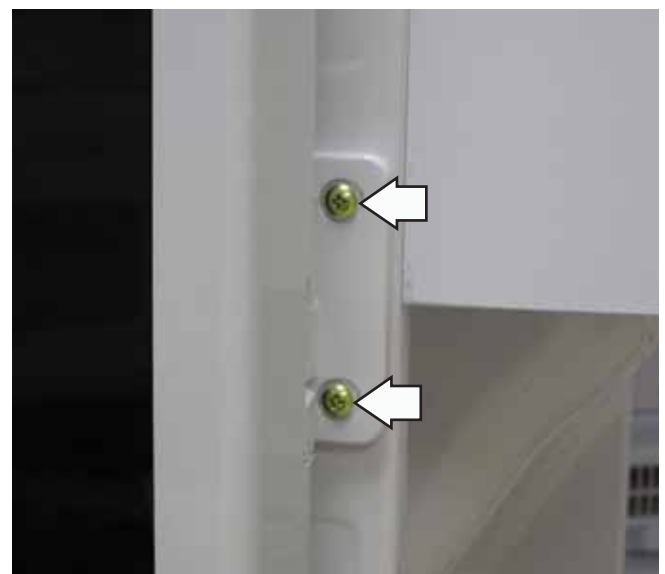

*(Continued next page)*

3. Grasp the mullion and pull it vertically upward to release it from the top and bottom retainers.



4. Pull out and disconnect the wire harness.



#### To disassemble the mullion assembly:

1. Remove the articulating door mullion assembly. (See *To remove the articulating door mullion assembly.*)

**Caution:** In the following step, care must be taken to prevent breakage of the door closure cover and/or door closure hinge.

2. Remove the door closure spring by pulling the top arm of the spring down and out of the door closure cover.
3. Lift the spring out of the door closure hinge.

**Note:** Be sure the spring sleeve is placed in the door closure cover before installing spring.

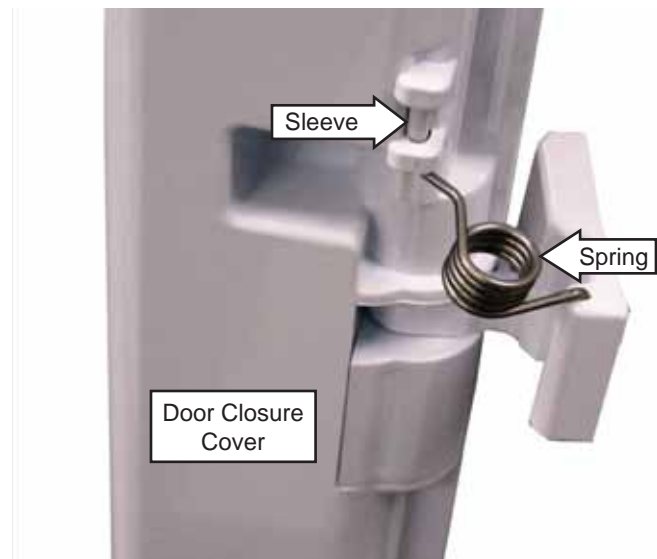

**Note:** The door closure support is held to the door closure cover with 13 tabs.

4. Using a putty knife or similar tool, carefully pry and lift the door closure support from the door closure cover.

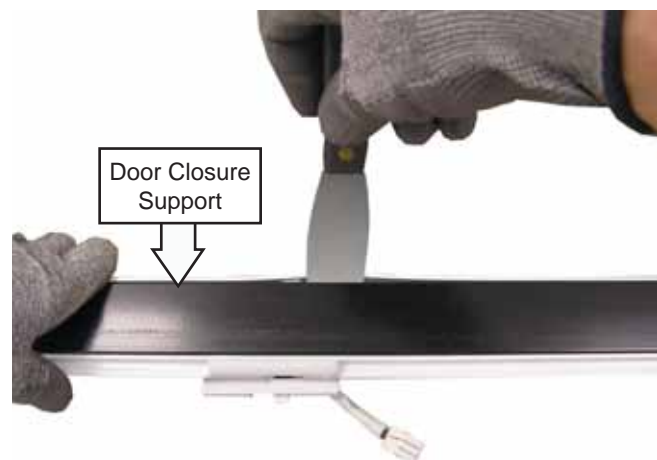

(Continued next page)



5. Using a putty knife or similar tool, carefully pry and lift the door closure case from the door closure cover.



8. Remove the door closure heater wire harness from the wire harness cover and the door closure cover.

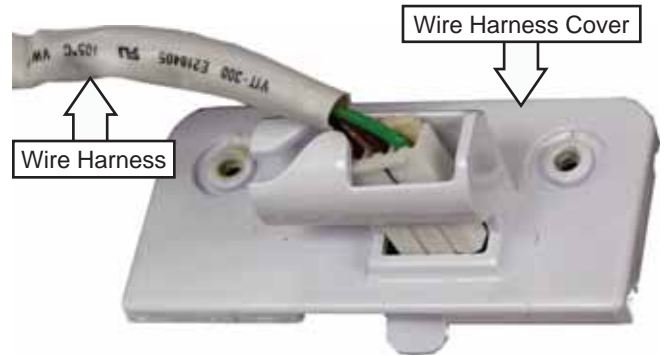

6. Remove the Phillips-head screw that attaches the center hinge cap to the door closure cover.



7. Using a small, flat blade screwdriver, pry out the center hinge cap.

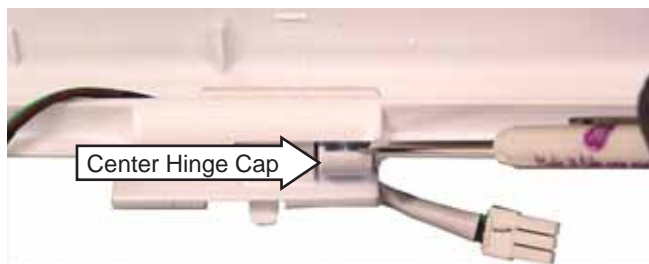

**Note:** There is a closure gasket attached to each end of the door closure support. Each gasket has 2 pins that pull through 2 holes in each end of the door closure support.

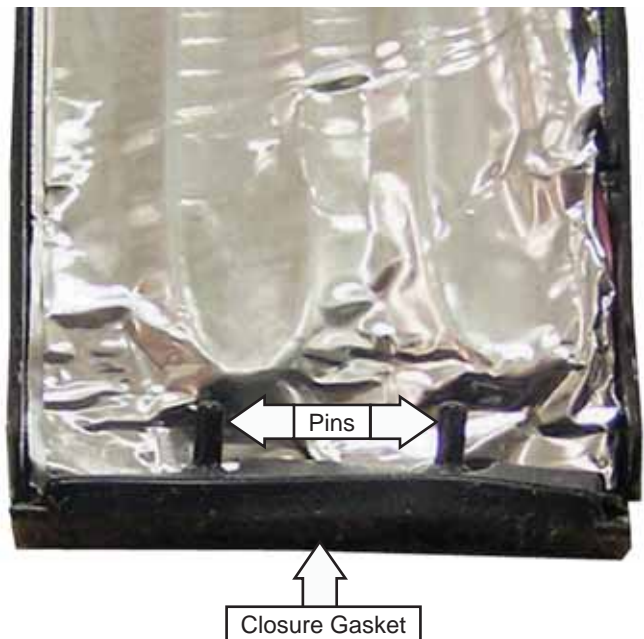



**Note:** In the following step, the ground wire connector utilizes a release/locking tab.

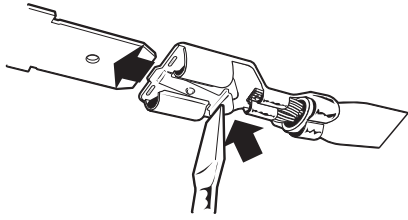

ELECTRICAL TERMINAL  
RELEASE/LOCKING TAB

9. Disconnect the heater ground wire from the door closure support.
10. Peel the door closure heater from the door closure support.

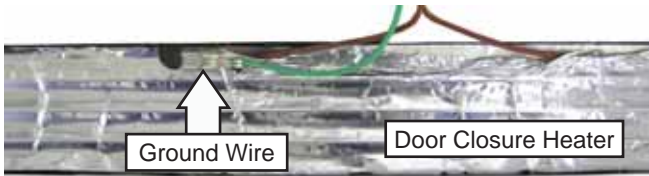

11. Using a flat blade screwdriver, pry and push the tab that holds the bottom and top hinge caps to the door closure cover.



## Control Panel Operation - LED

### Showroom Mode

**Note:** There is no off mode that can be accessed using the display.

To enter the showroom mode, press ENERGY SAVER and ADJUST FREEZER pads simultaneously for 3 seconds. OF - OF will be displayed. The lights and fans (if previously operating) will still operate, but the compressor will not operate. To return to normal operation, press ENERGY SAVER and ADJUST FREEZER pads simultaneously for 3 seconds. Unplugging the refrigerator does not escape showroom mode.

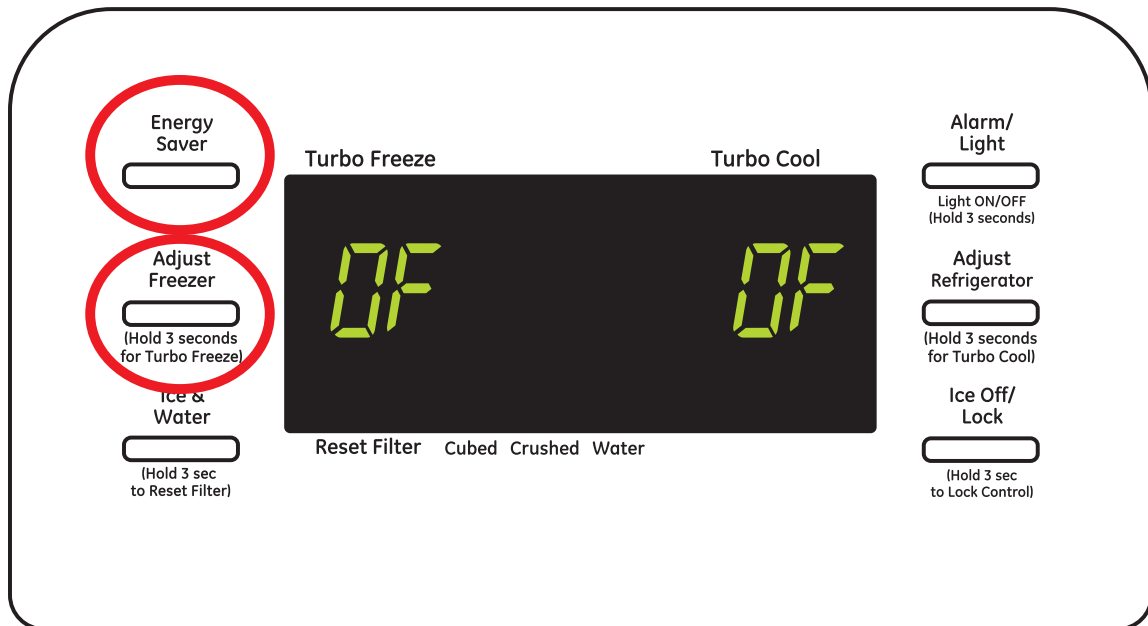

### Temperature Adjustment

The temperature controls are preset in the factory at 38°F (3.3°C) for the refrigerator compartment and -2°F (-18.9°C) for the freezer compartment. The refrigerator compartment can be set anywhere between 34°F (1.1°C) and 46°F (7.7°C). The freezer compartment can be set anywhere between -14°F (-25.5°C) and 8°F (-13.3°C). Press and release ADJUST FREEZER or ADJUST REFRIGERATOR pads continuously until the desired temperature is displayed.

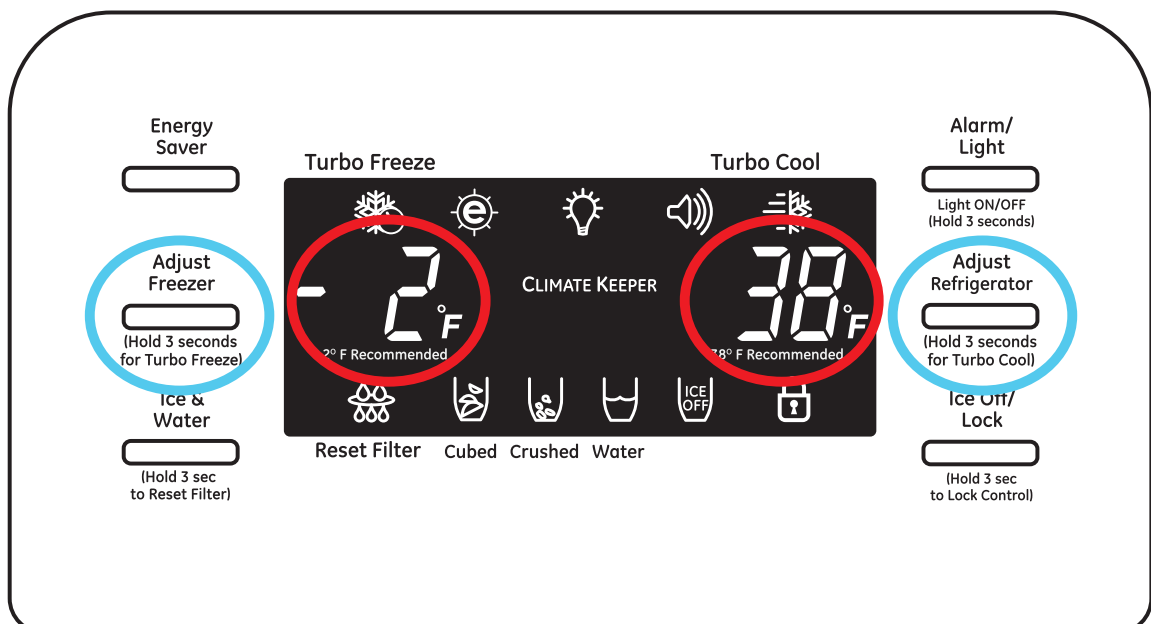

## Energy Saver

Press ENERGY SAVER to turn the articulating mullion heater on or off.

## Alarm/Light

When selected to the ON mode, the door alarm will sound an alarm if a refrigerator door or the freezer drawer is open for more than 3 minutes. Pressing the ALARM/LIGHT pad for 3 seconds turns the dispenser lights on or off.

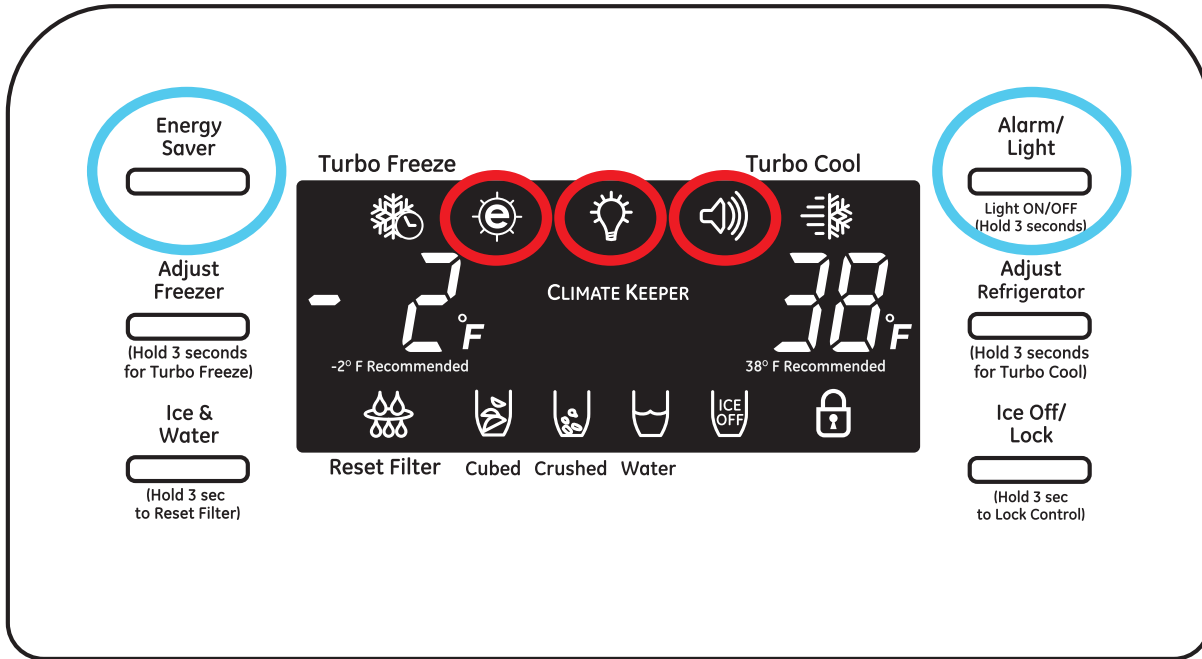

## Turbo Freeze and Turbo Cool

**Note:** Select Turbo Freeze or Turbo Cool separately. When Turbo Freeze or Turbo Cool is selected, the customer set temperatures in the freezer and refrigerator can not be changed.

### Turbo Freeze Function

To select or cancel Turbo Freeze, press and hold the ADJUST FREEZER pad for 3 seconds.

When you select Turbo Freeze, the LED indicator is displayed immediately, but there is 10 seconds lag time to engage the actual operation. When Turbo Freeze is cancelled, the Turbo Freeze function stops and the indicator turns off immediately. When selected, both the compressor and the freezer fan run for 2.5 hours continuously. After 2.5 hours has elapsed or if Turbo Freeze has been cancelled, the indicator goes off and the freezer set temperature will be restored.

### Turbo Cool Function

To select or cancel Turbo Cool, press and hold the ADJUST REFRIGERATOR pad for 3 seconds. The operation of Turbo Cool is the same as Turbo Freeze with the following exception: When Turbo Cool is selected, the compressor and refrigerator fan will operate until the refrigerator temp reaches 25°F (-3.9°C), or if 2½ hours expires. At this point, the cycle will be terminated.

### Note

- When Turbo Freeze and Turbo Cool are selected to operate at the same time, the compressor and freezer fan run continuously and the refrigerator fan runs until 25°F (-3.9°C) is reached in the refrigerator.
- If Turbo Freeze is selected when the freezer and the refrigerator temperatures are higher than 14°F (-10°C) and 50°F (10°C), respectively, the refrigerator fan will be off. If Turbo Cool is selected, then the freezer fan will be off. When both functions are selected, there is no benefit of fast cooling for either compartment.

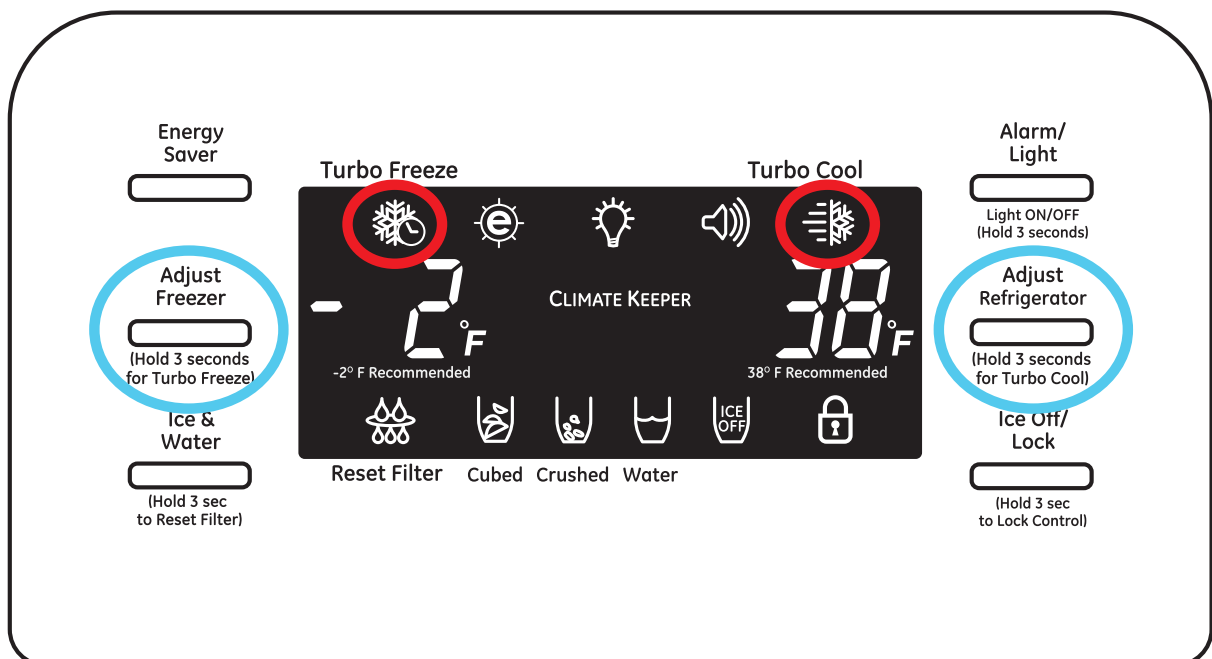

## Ice & Water

To select cubed ice, crushed ice, or water, press the ICE & WATER pad. Repeated pressing of the pad will toggle between cubed ice, crushed ice and water.

### Filter Reset Function

To reset the water filter indicator, press and hold the ICE & WATER pad for 3 seconds.

### Note

The reset filter indicator will always be illuminated. If the filter is OK, the color is green. As the filter becomes restricted the indicator will turn yellow. A red color indicates the filter needs to be replaced. Resetting the filter indicator will turn the indicator back to green.

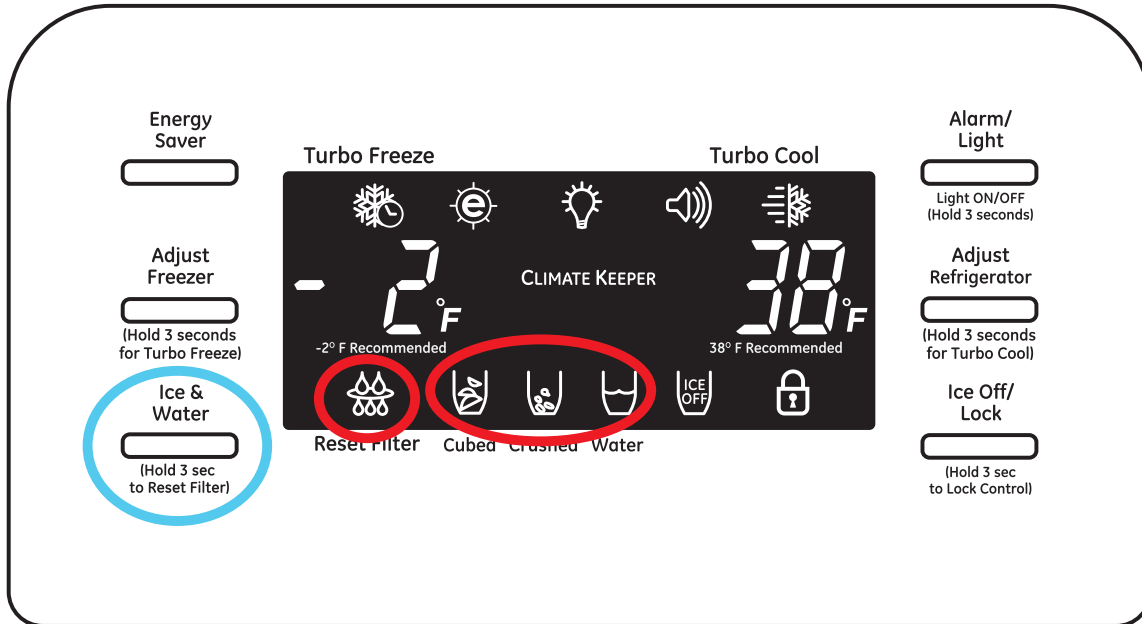

## Ice Off/Lock

To turn off the ice maker, press the ICE OFF/LOCK pad.

To lock the control panel and dispenser, press and hold the ICE OFF/LOCK pad for 3 seconds.

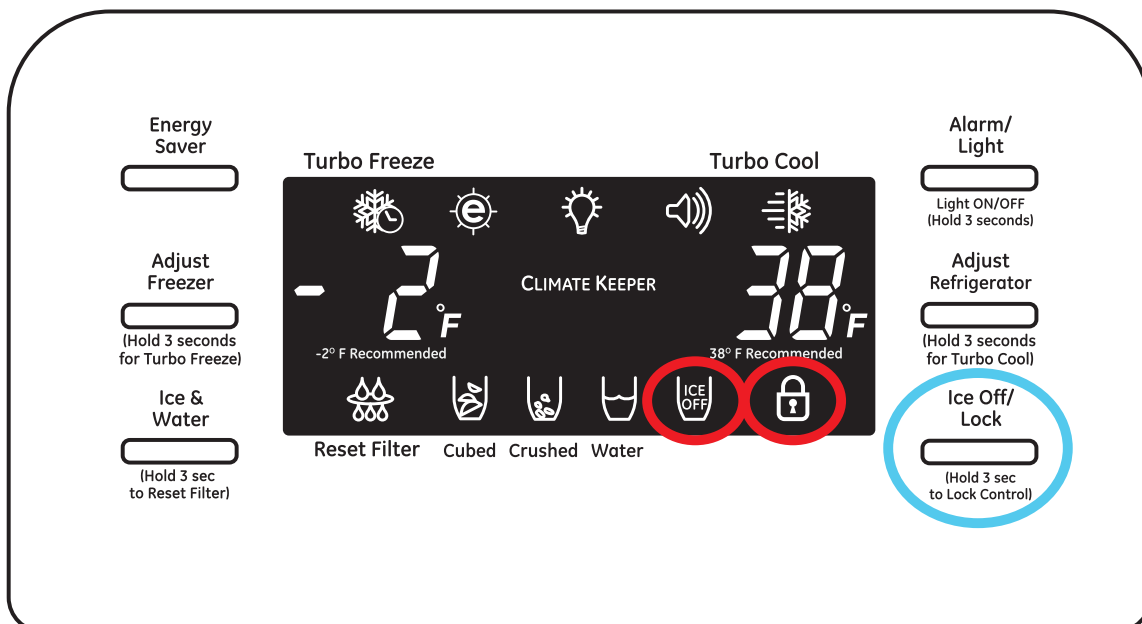



# Troubleshooting

## Test Mode Operation - LCD

### Hidden Boot Error Indicator

On initial power up, the water filter status display should have a white background.



If an error is detected in the system upon power up, the water filter indicator background color will change from white to dark blue. The color will remain dark blue until the problem is corrected or for 3 hours; whichever comes first.



## Entering Diagnostic Mode

To enter the diagnostic mode, press SETTINGS pad from the main screen.

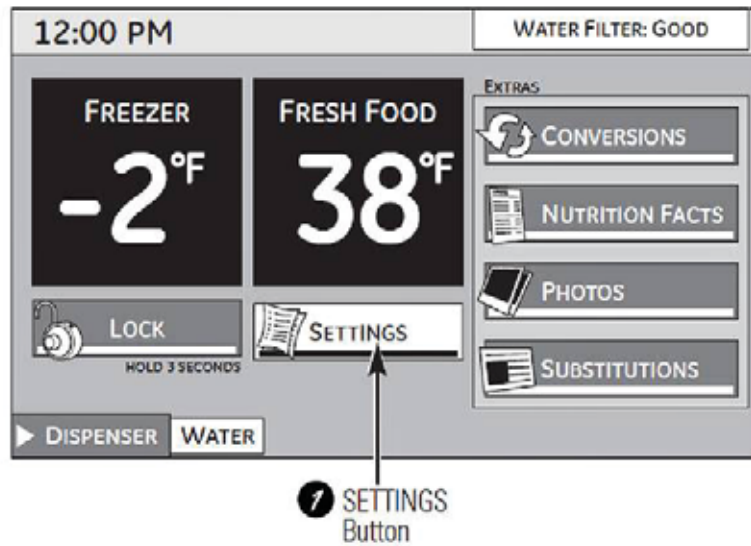

Tap the "A" and "B" zones on the settings screen three times each in an alternating sequence within the first 5 seconds.

A-B-A-B-A-B-A

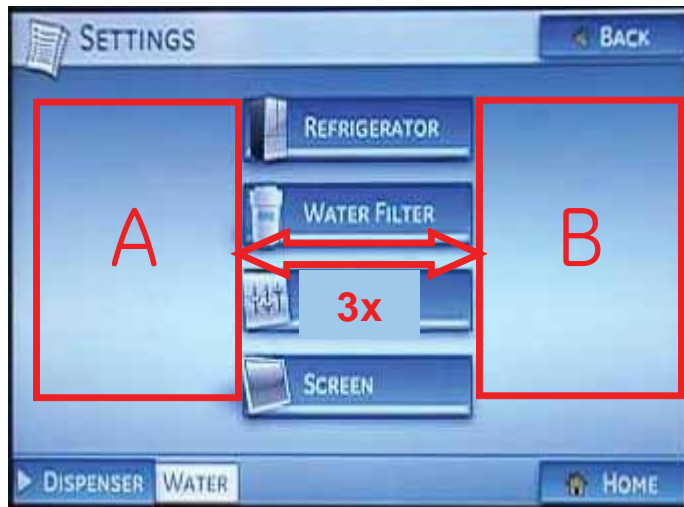

## Diagnostic - Dealer Demo Mode

In diagnostic mode, you have the option to turn on (start) or off (stop) the “**Showroom Mode**” of operation.

**Note:** There is no visual clue on the Home screen that the unit is in the showroom mode.

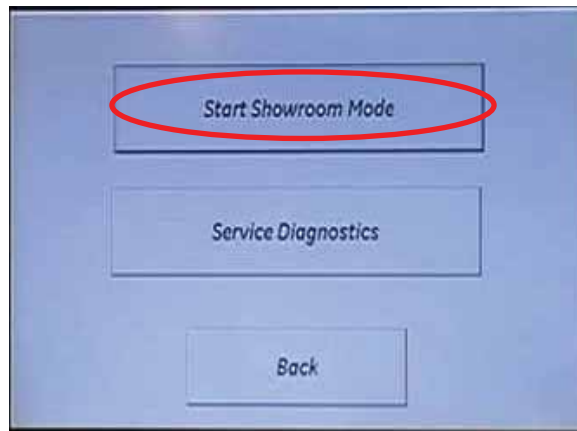

A second diagnostic operation is the field “**Service Diagnostics**” mode. This option will allow you to check for failure codes. Service diagnostics mode shows which components are being operated by the main control board.



## Diagnostic Functions

Selecting "Self Diagnostic Test" displays a screen showing detected error codes. They are shown with a pass or fault status with a text message on what the error is..

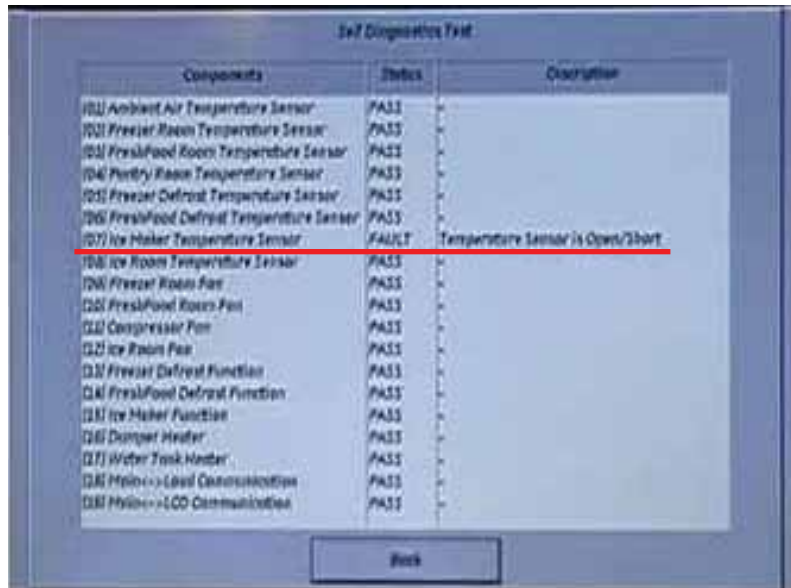

The image shows a screen titled "Self Diagnostic Test" displaying a table of diagnostic results. The table has three columns: Components, Status, and Description. The row for "Ice Maker Temperature Sensor" is highlighted with a red line.

Components	Status	Description
001 Ambient Air Temperature Sensor	PASS	
002 Freezer Room Temperature Sensor	PASS	
003 FreshFood Room Temperature Sensor	PASS	
004 Purify Room Temperature Sensor	PASS	
005 Freezer Defrost Temperature Sensor	PASS	
006 FreshFood Defrost Temperature Sensor	PASS	
007 Ice Maker Temperature Sensor	FAULT	Temperature Sensor is Open/Short
008 Ice Room Temperature Sensor	PASS	
020 Freezer Room Fan	PASS	
021 FreshFood Room Fan	PASS	
022 Compressor Fan	PASS	
023 Ice Room Fan	PASS	
024 Freezer Defrost Function	PASS	
025 FreshFood Defrost Function	PASS	
026 Ice Maker Function	PASS	
027 Damper Heater	PASS	
028 Water Tank Heater	PASS	
029 Main <-> Local Communication	PASS	
030 Main <-> LCD Communication	PASS	

Back

Selecting "Refrigerator Load Status" displays a screen report showing what loads are turned on or off at the present time and what the current fan speeds are.



The screenshot shows a table titled "Refrigerator Load Status" with two columns: "Component" and "Status". The table lists various components and their current status. A red oval highlights the "Status" column.

Component	Status
Freezer Room Fan	LOW
FreshFood Room Fan	OFF
Compressor Fan	LOW
Ice Room Fan	HIGH
Compressor	ON
Freezer Defrost Heater	OFF
FreshFood Defrost Heater	OFF
Dispenser Heater	ON
Water Tank Heater	OFF
French Heater	ON
Damper	OFF

A "Back" button is located at the bottom of the screen.



The "S/W Version" displays the code which tells you the software versions of the main and LCD boards.

The "HMI Test" allows for calibration of the touch screen. This calibration defines the touch zones of the buttons on the screen. You will be prompted to touch different areas of the screen to calibrate the zones..

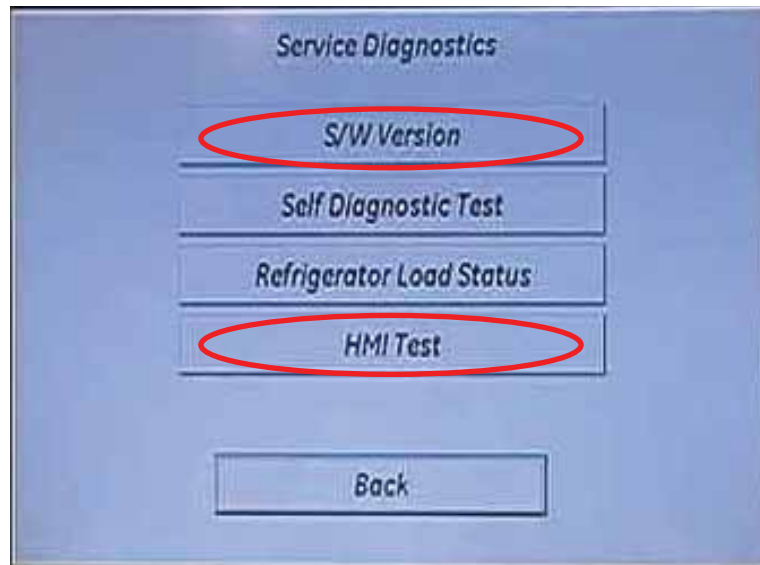

Once you have entered the standard diagnostic mode, you can enter an extended developer mode to run forced functions for the sealed system and defrost. If you tap the bottom corners of the screen, starting on the left and then right seven times, you will enter developer mode.

A-B-A-B-A-B-A

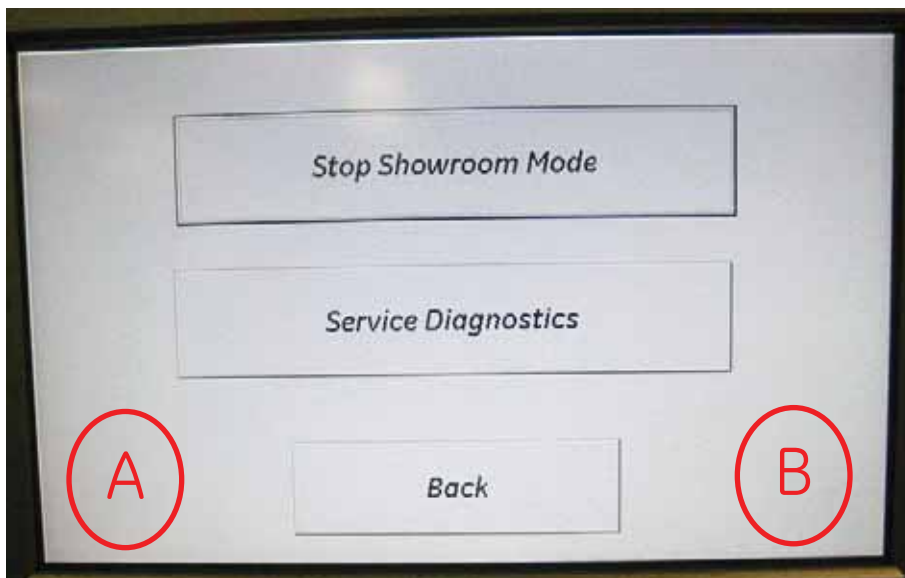

Once in developer mode, you will still have the options for error codes and load status. You will also see an option for "Force Run/Defrost A/S Test".

Pressing the "Force Run/Defrost A/S Test" turns on all loads, compressor, and fans and turns on the defrost heaters for testing.

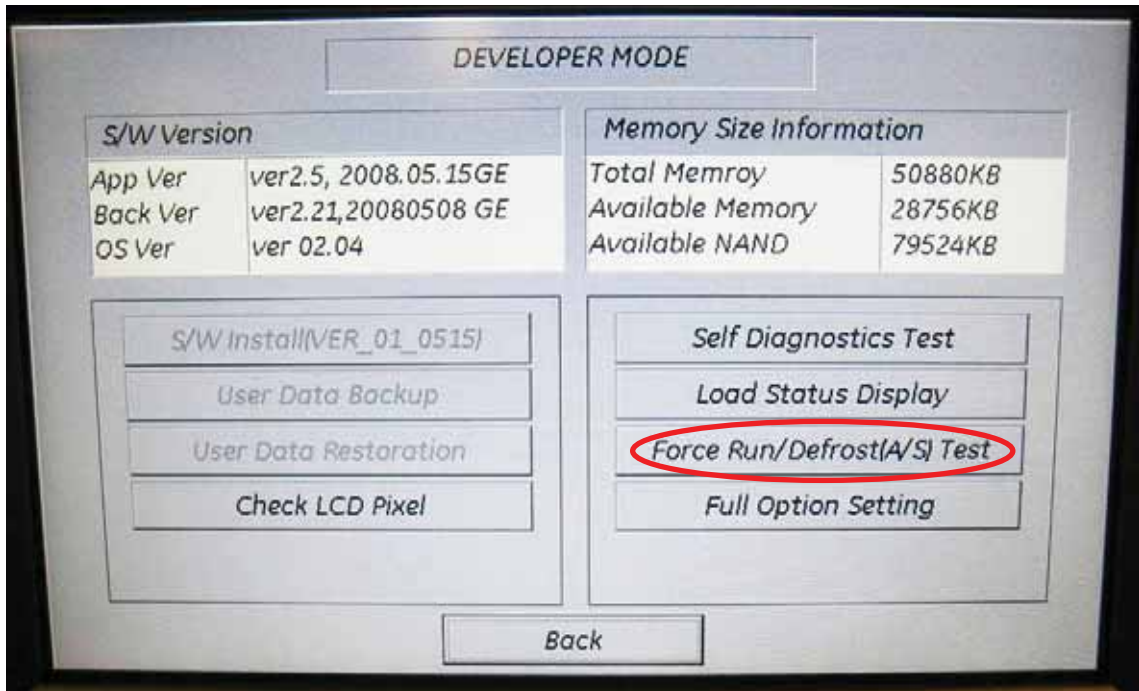

Note: "Full Option Setting" is for factory use only

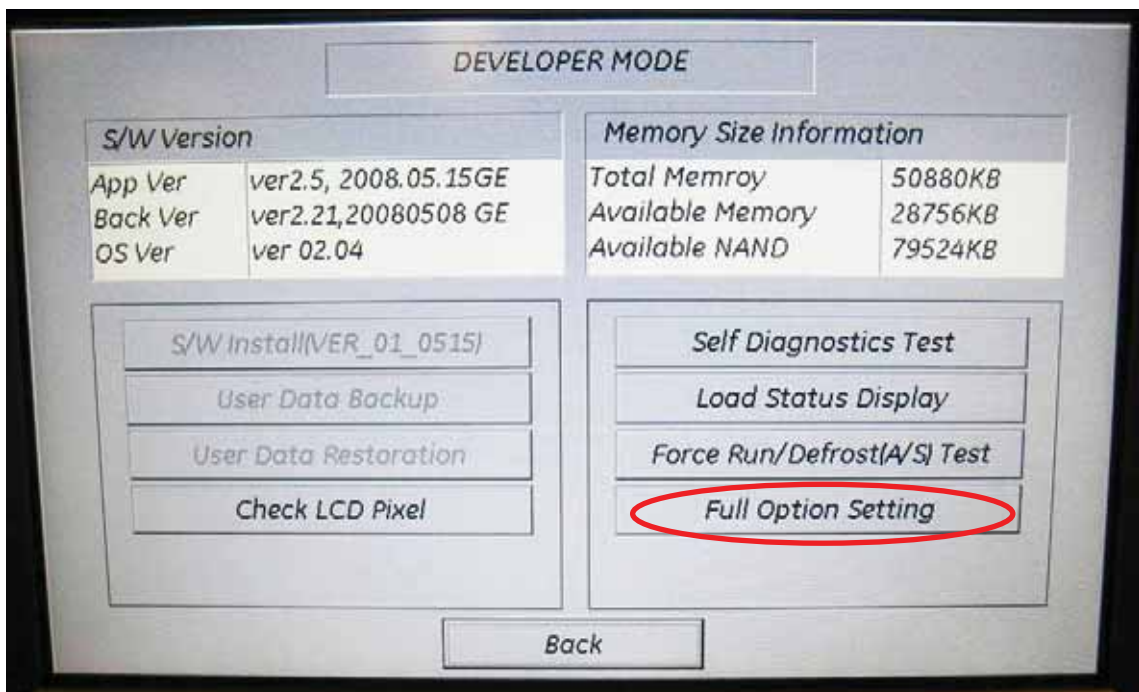

## Test Mode Operation - LED

### Test Mode – Manual Operation/Manual Defrost

To enter the test mode, press ENERGY SAVER and ADJUST REFRIGERATOR pads simultaneously for 8 seconds. The display panel will go blank. Press any pad within 15 seconds to initiate test mode.

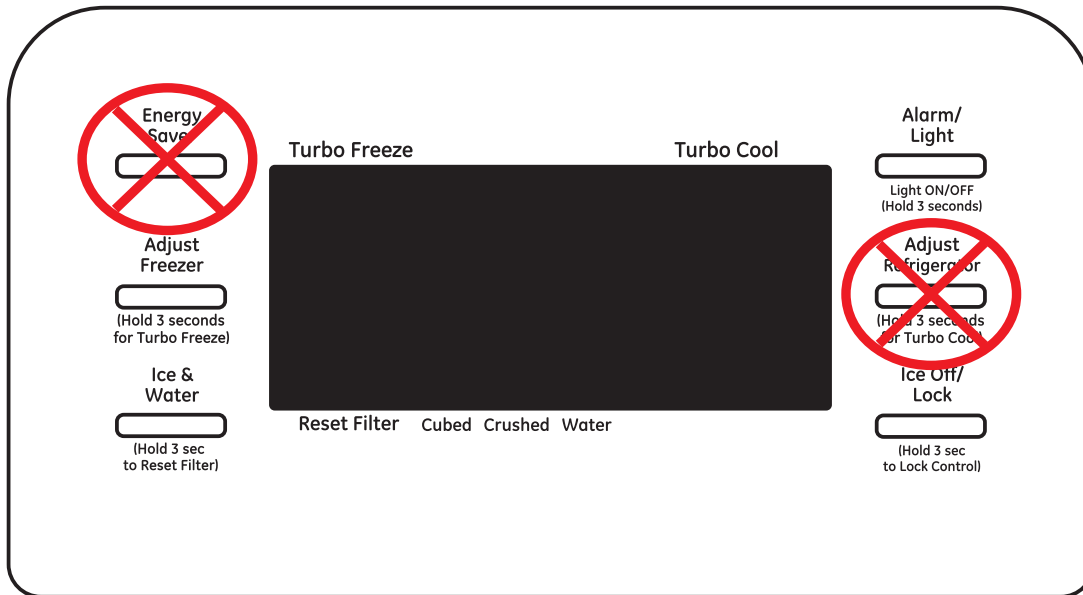

If any pad is pressed within 15 seconds it will generate the following sequence:

1st press - Manual operation – Compressor and Fans (FF) Displayed

2nd press - Manual Defrost – Fresh Food Compartment (rd) Displayed

3rd press - Manual Defrost – FF and Frz Compartments (Fd) Displayed

4th press - Cancel – (Display Off) Normal Operation is restored after approximately 10 seconds.

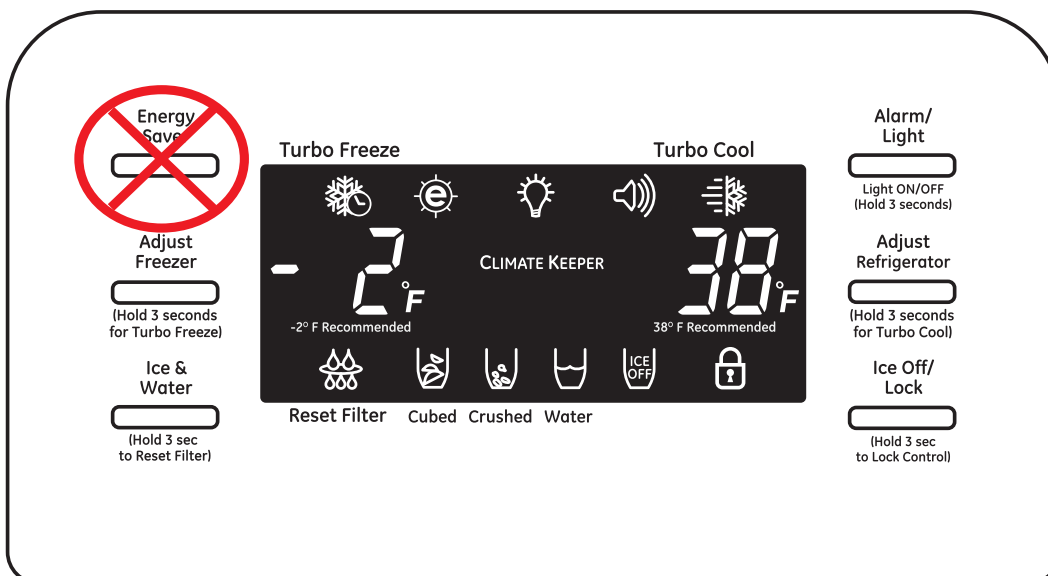

**Note:** Test mode can also be canceled by removing power and then powering unit back up.

**Display Function – Communication Errors**

If there is no communication for 10 seconds after request between the control panel and the main board, the display will flash Pc Er until the communication error is corrected. The refrigerator will continue to operate normally. A flashing Pc Er can be caused by a communication circuit failure on the main board and/or the control panel board, or a loose connection.

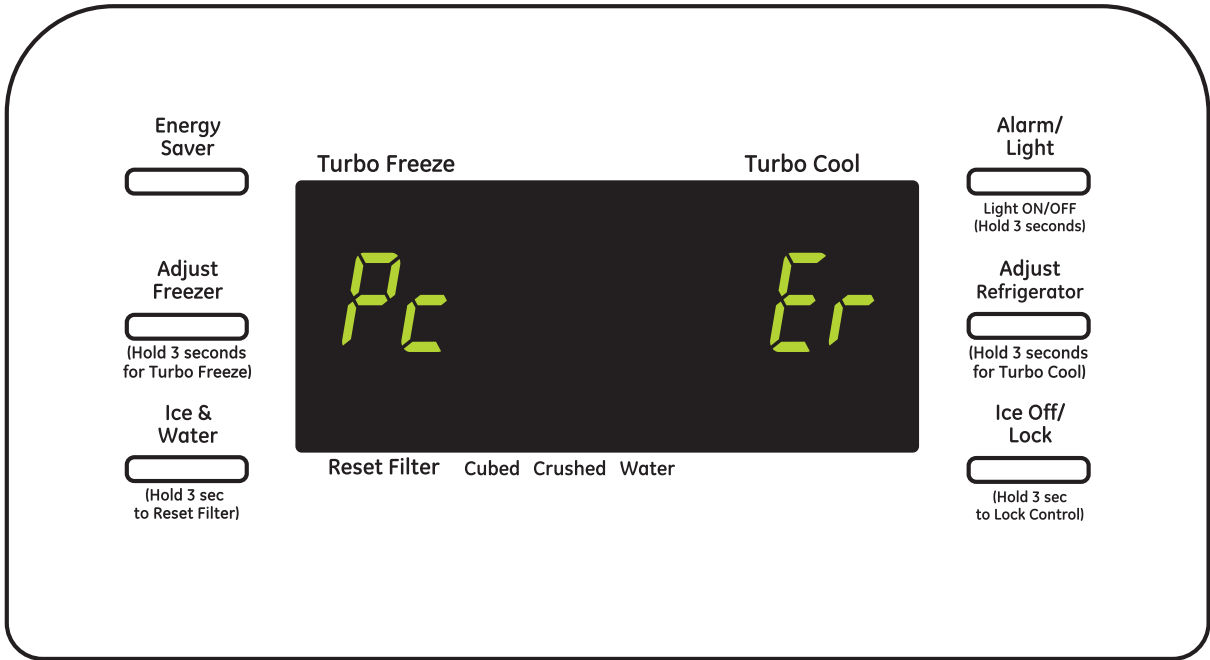

If there is no communication for 20 seconds after request between the integrated circuits (IC Chips) on the main board, the display will flash Lc Er until the communication error is corrected. The pantry room control will also flash until the communication error is corrected. The refrigerator will continue to operate normally. A flashing Lc Er is caused by a communication circuit failure on the main board.

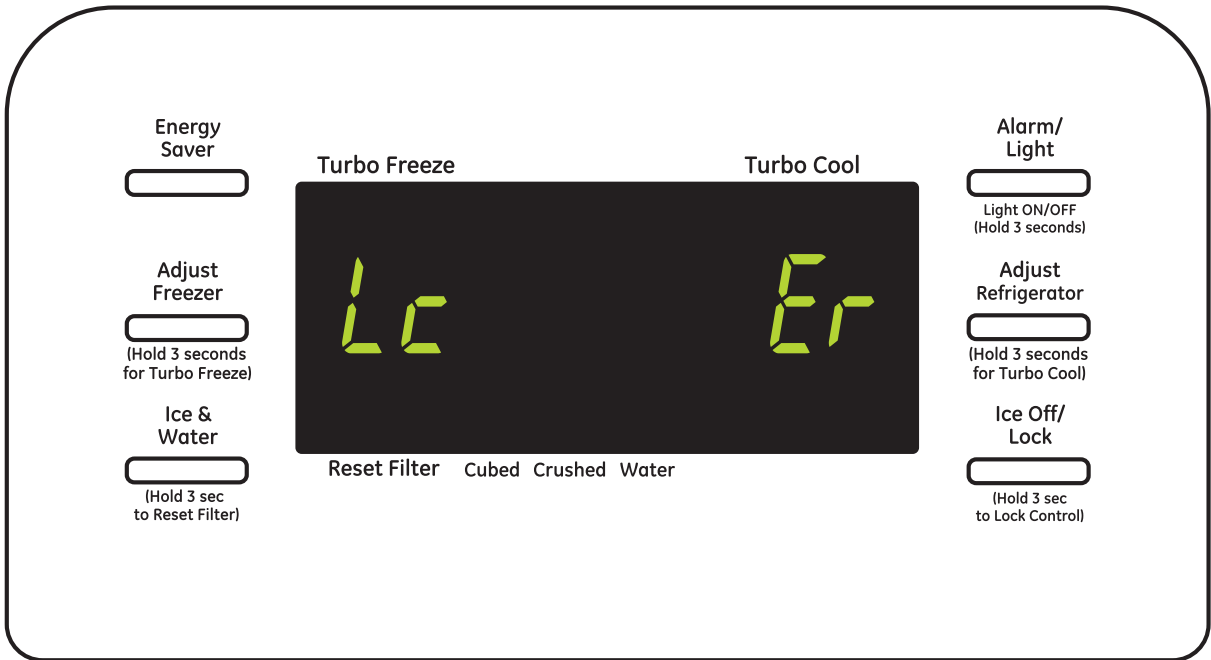

## Failure and Load Condition Displays

The display can utilize individual segments of a particular figure "8" that will flash to indicate failure or load conditions.

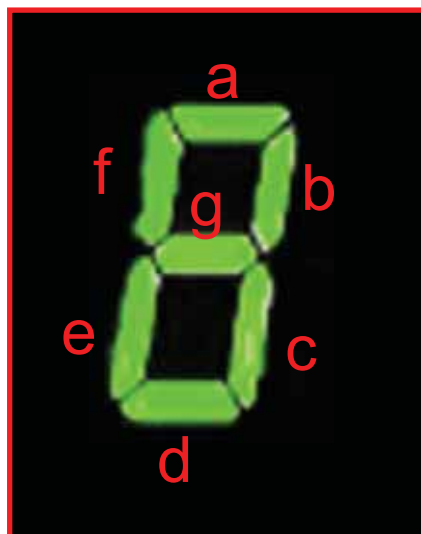
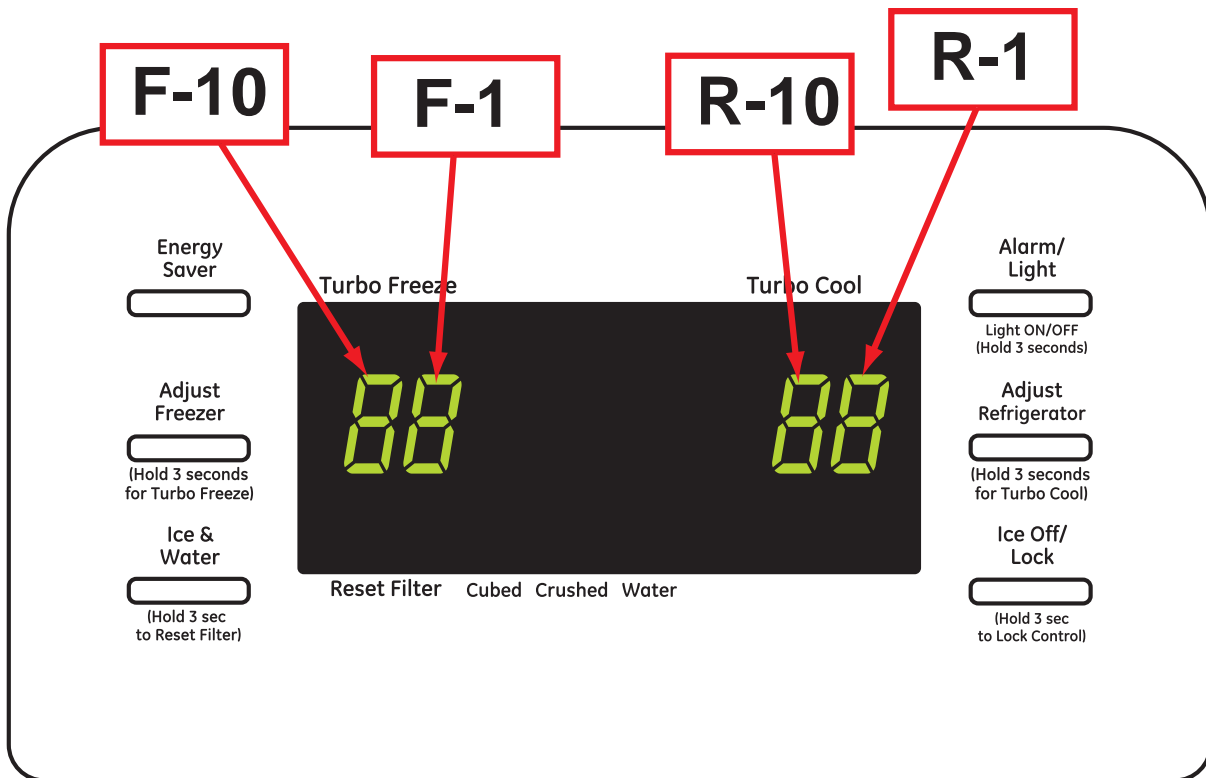



## Failure Conditions – Initial Power Up

Upon initial power up, if certain failed components have been detected, individual segments of a particular figure “8” will flash to indicate the failed components.

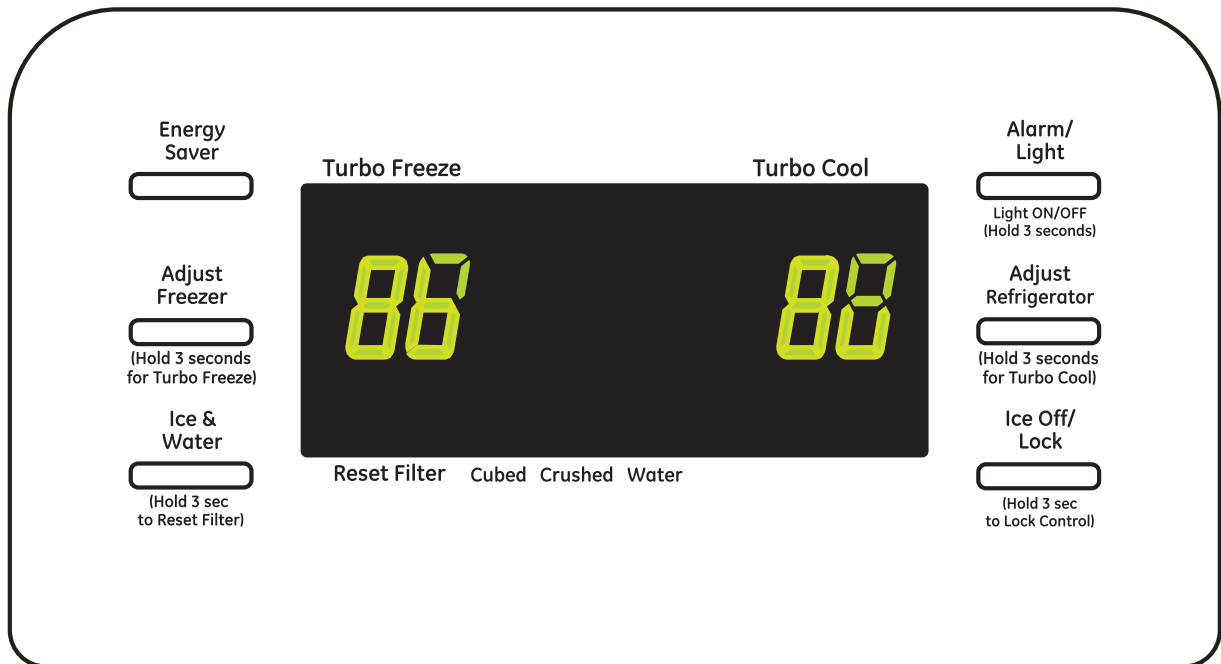

To return the display to normal, simultaneously press the ENERGY SAVER and ALARM/LIGHT pads for 8 seconds.

**Note:** The failure condition will still exist when returning the display to normal. For proper operation of the refrigerator, correct or replace the faulty component.

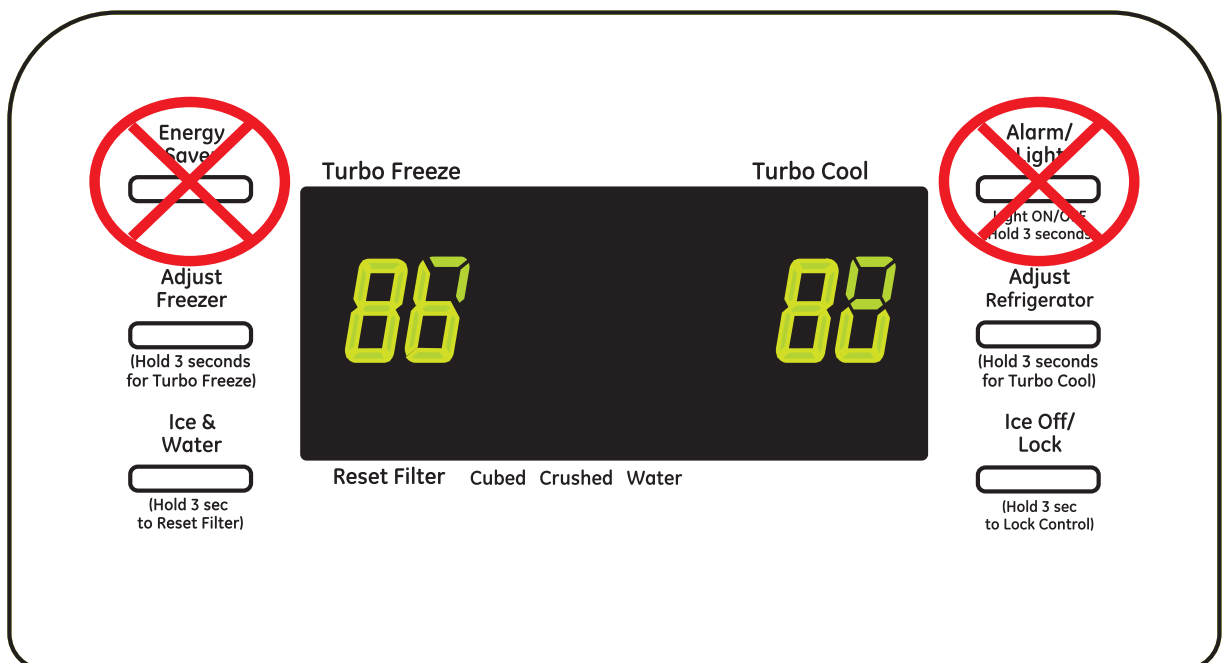

## Failure Condition Display Code Table

NO	Trouble Item	Display LED	Trouble Contents
1	Icemaker Sensor Error	R-1- <b>(a)</b>	Icemaker Sensor part error
2	Refrigerator Sensor Error	R-1- <b>(b)</b>	Refrigerator Sensor part error
3	Refrigerator Defrost Sensor Error	R-1- <b>(c)</b>	Refrigerator Defrost Sensor part error
4	Refrigerator Fan Error	R-1- <b>(d)</b>	Refrigerator inner part error
5	Icemaker error	R-1- <b>(e)</b>	Icemaker operation error
6	Refrigerator Defrost Heater Error	R-1- <b>(g)</b>	Refrigerator defrost part error
7	Ambient Sensor Error	F-1- <b>(a)</b>	External Sensor part error
8	Freezer Sensor Error	F-1- <b>(b)</b>	Freezer Sensor part error
9	Freezer Defrost Sensor Error	F-1- <b>(c)</b>	Freezer Defrost Sensor part error
10	Freezer Fan Error	F-1- <b>(d)</b>	Freezer inner fan motor part error
11	Condenser Fan Error	F-1- <b>(e)</b>	Machine room fan motor part error
12	Ice Room Sensor Error	F-1- <b>(f)</b>	Ice Room Sensor part error
13	Freezer Defrost Heater Error	F-1- <b>(g)</b>	Freezer Defrost part error
14	Ice Room Fan Error	F-10- <b>(b)</b>	Ice Room inner fan motor part error
15	Pantry Damper Heater Error	R-10- <b>(a)</b>	Damper Heater open/wire error
16	Pantry Sensor Error	R-10- <b>(b)</b>	Pantry Room Sensor part error
17	Panel-Main Micom Error	F-10- <b>(g)</b>	Panel-Main Micom communication error
18	L-M Communication Error	F-10- <b>(f)</b>	LOAD-Main Micom communication error
19	Water Tank Heater Error	R-10- <b>(g)</b>	Water Tank Heater open/wire error

## Load Condition Displays

To access the load condition display, press ENERGY SAVER and ALARM/LIGHT pads simultaneously for 6 seconds. The display will beep and start to flash. Immediately remove fingers from previous pads and press the ADJUST REFRIGERATOR pad. The load condition mode will then be energized.

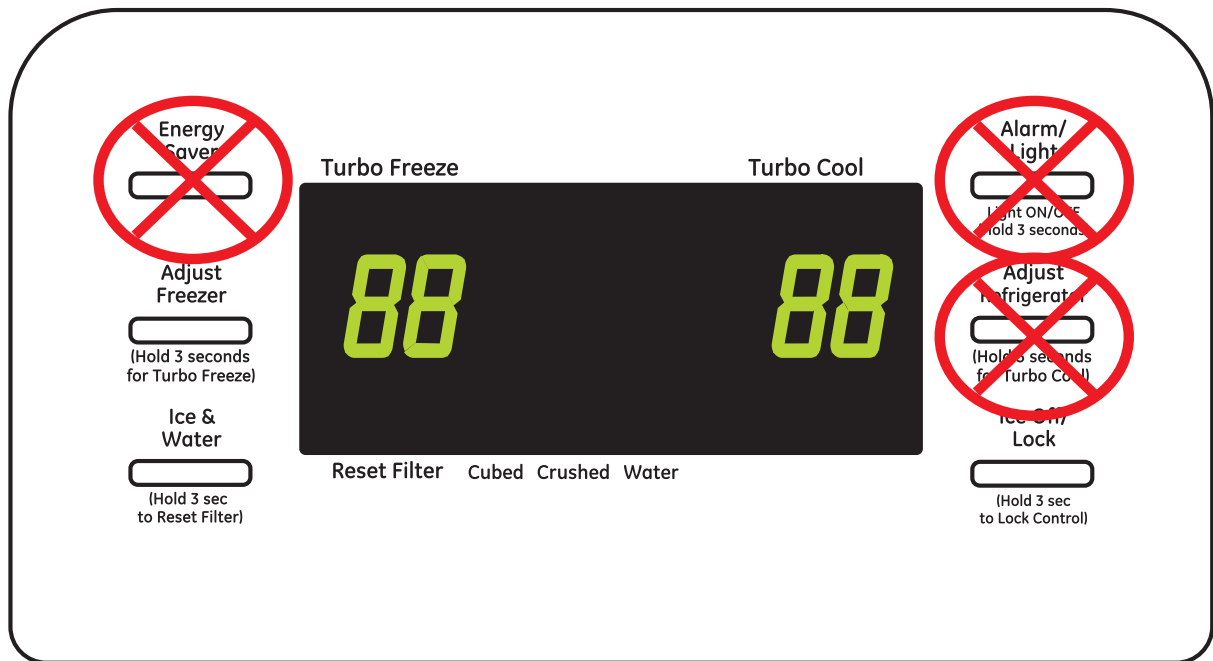

Segments of the figure "8"s will blink on and off corresponding to the loads that the main board has energized.

**Note:** Just because the board has a load energized does not mean that the component is functioning.

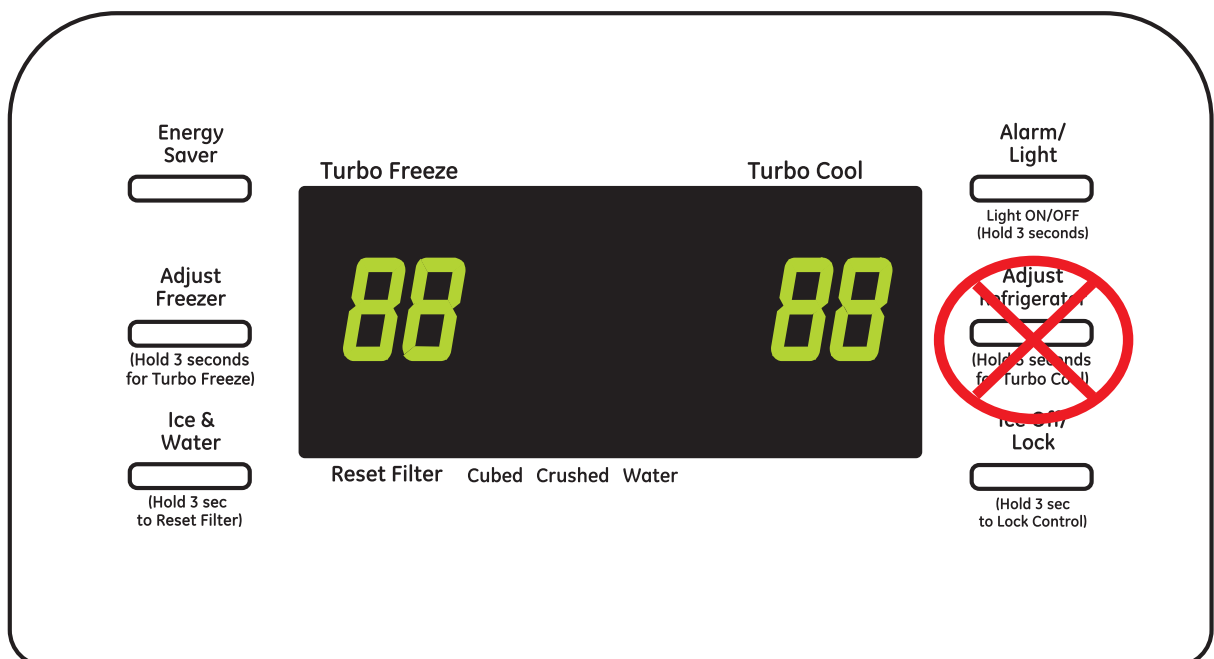

## Load Condition Display Code Table

Display LED	Display Contents	Operation Contents
R-1- (a)	Refrigerator Fan High	When fresh food compartment fan high operates, applicable LED ON
R-1- (b)	Refrigerator Fan Low	When fresh food compartment fan low operates, applicable LED ON
R-1- (c)	Refrigerator Defrost Heater	When fresh food compartment defrost heater operates, applicable LED ON
R-1- (d)	Start Mode	Initial power ON refrigerator, applicable LED ON
R-1- (e)	Overload Condition	When ambient temperature is more than 93°F (34°C), applicable LED ON
R-1- (f)	Low Temperature Condition	When ambient temperature is less than 72°F (22°C), applicable LED ON
F-1- (e)(f) ALL LED OFF	Normal Condition	When ambient temperature is between 73°F (23°C) and 91°F (33°C), applicable LED ON
R-1- (g)	Exhibition Mode	Display mode, applicable LED ON
F-1- (a)	Compressor	When compressor operates, applicable LED ON
F-1- (b)	Freezer Fan High	When freezer compartment fan high operates, applicable LED ON
F-1- (c)	Freezer Fan Low	When freezer compartment fan low operates, applicable LED ON
F-1- (d)	Freezer Defrost Heater	When freezer compartment defrost heater operates, applicable LED ON
R-10- (e)	Condenser Fan High	When condenser fan high operates, applicable LED ON
R-10- (f)	Condenser Fan Low	When condenser fan low operates, applicable LED ON
F-10- (g)	French Heater	When french heater operates, applicable LED ON
F-1- (g)	Dispenser Heater	When dispenser heater operates, applicable LED ON
F-10- (a)	Water Tank Heater	When water tank heater operates, applicable LED ON
F-10- (d)	Ice Room Fan High Ice	When ice room fan high operates, applicable LED ON
F-10- (e)	Ice Room Fan Low	When ice room fan low operates, applicable LED ON

## Self Diagnostics – During Normal Operation

To enter self diagnostics during normal operation of the refrigerator, press the ENERGY SAVER and ALARM/LIGHT pads for 6 seconds. The display will beep and flash. Continue to press both pads for an addition 2 seconds to enter the self diagnostic mode.

If any failure functions are present, those segments will now begin to flash.

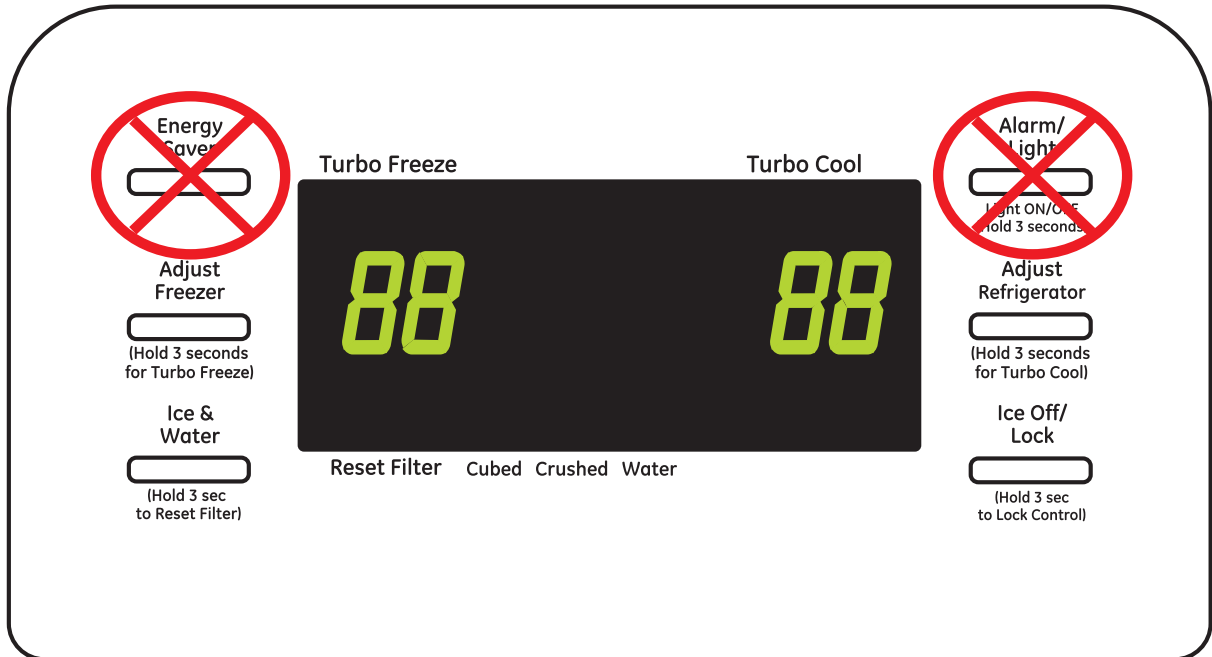

The self diagnostics mode will be displayed for 30 seconds, then the panel will return to normal display.

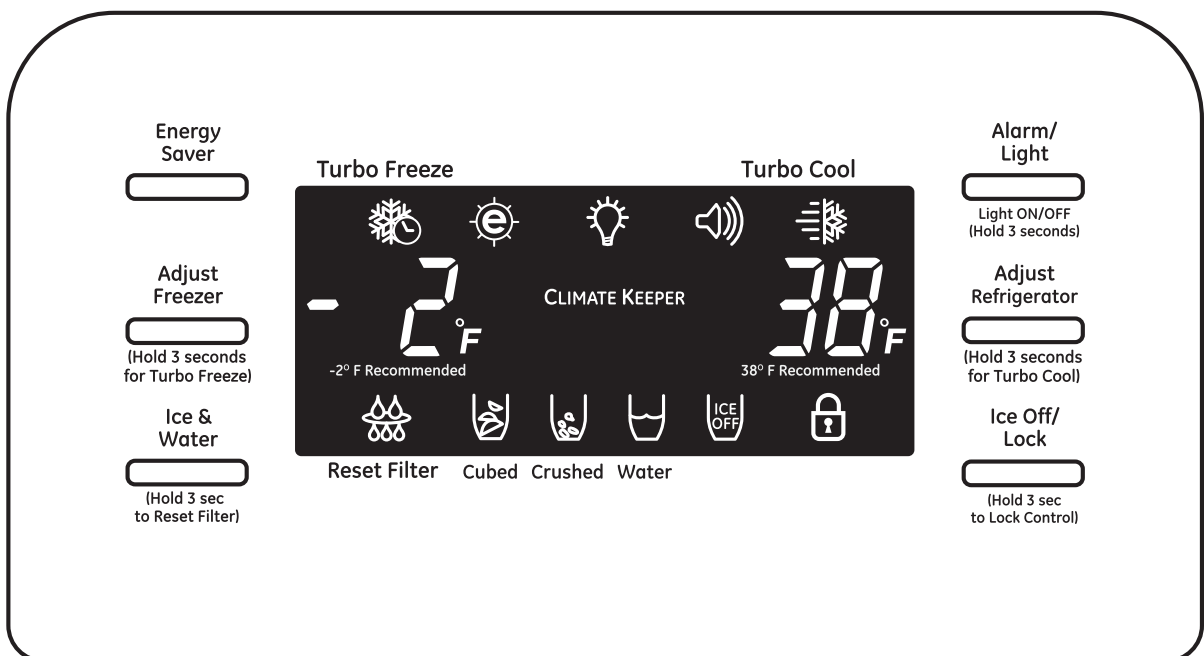



## Self Diagnostics – During Normal Operation Table

LED	Item	Trouble Contents	Diagnostic Method
R-1-Ⓐ	Icemaker Sensor Error	Display error: separation of sensor housing part, contact error, disconnection, short circuit	When checking the voltage of MAIN PCB CN90 #3 to CN90 #4: should be between 4.5 to 1.0V.
R-1-Ⓑ	Refrigerator Sensor Error	Display error of detecting temperature of sensor: more than 149°F (+65°C) or less than -58°F (-50°C)	When checking the voltage of MAIN PCB CN30 #6 to CN75 #1: should be between 4.5 to 1.0V.
R-1-Ⓒ	Refrigerator Defrost Sensor Error		When checking the voltage of MAIN PCB CN #7 to CN75 #1: should be between 4.5V to 1.0V.
R-1-Ⓓ	Refrigerator Fan Error		Voltage of MAIN PCB CN75 orange to gray should be between 7v to 12V.
R-1-Ⓔ	Icemaker Error	Display error: ice making kit is harvested more than 3 times and level error. Note: Apply to the applicable icemaker model.	After replacing icemaker, check the operation by turning the appliance ON again.
R-1-ⓐ	Refrigerator Defrost Error	Display error: separation of fresh food compartment defrost heater housing part, contact error, disconnection, short circuit or temperature fuse error  Display error: the fresh food compartment defrosting does not finish. Defrost is heating continuously for more than 80 minutes.	After separating MAIN PCB CN70, CN71, from PCB, check the resistance value between CN70 white to CN71 orange. It should be 102 ohms ±7%. (Resistance value is varied by the input power.) Check 0 ohm: heater short, ∞ ohm: wire/ bimetal open.
F-1-Ⓐ	Ambient Sensor Error	Display error: sensor housing separation, contact error, disconnection, short circuit	Check the voltage of MAIN PCB CN32 #1 to #4. It should be between 4.5V to 1.0V.
F-1-Ⓑ	Freezer Sensor Error	Display error by detecting temperature of sensor: more than 149°F (+65°C) or less than -58°F (-50°C)	Check the voltage of MAIN PCB CN30 #3 to CN75 #1. It should be between 4.5V to 1.0V.
F-1-Ⓒ	Defrost Sensor Error		Check the voltage of MAIN PCB CN30 #4 to CN75 #1. It should be between 4.5V to 1.0V.
F-1-Ⓓ	Freezer Fan Error	Display error during operation of fan motor: feed back signal line contact error, motor wire separation, motor error	Voltage of MAIN PCB CN75 yellow to gray should be between 7V to 12V.
F-1-Ⓔ	Condenser Fan Error	Display error during operation of fan motor: feed back signal line contact error, motor wire separation, motor error	Voltage of MAIN PCB CN75 sky blue to gray should be between 7V to 12V.

LED	Item	Trouble Contents	Diagnostic Method
F-1-ⓕ	Ice Room Sensor Error	Display error: sensor housing separation, contact error, disconnection, short circuit  Display error by detecting temperature of sensor: more than 149°F (+65°C) or less than -58°F (-50°C)	Check the voltage of MAIN PCB CN32 #3 to CN75 #1. It should be between 4.5V to 1.0V.
F-1-ⓐ	Freezer Defrost Error	Display error: separation of freezer compartment defrost heater housing part, contact error, disconnection, short circuit, or temperature fuse error  Display error: The defrosting does not finish through fresh food compartment. Compartment defrost is heating continuously for more than 70 minutes.	After separating MAIN PCB CN70 and CN71 from PCB, check the resistant value between CN70 brown to CN71 orange. It should be 102 ohms ±7%. (Resistance value is varied by the input power.) Check 0 ohm: heater short, ∞ ohm: wire/bimetal open.
F-10-ⓑ	Ice Room Fan Error	Display error during operation of fan motor: feedback signal line contact error, motor wire separation, motor error	Voltage of MAIN PCB CN76 black to CN75 gray should be between 6V to 12V.
R-10-ⓐ	Pantry Damper Heater Error	Display error: when open error is detected by damper heater: separation of damper heater housing part, contact error, disconnection, short circuit	After separating MAIN PCB CN91 from PCB, check the resistant value between black to brown wire. It should be 145 ohms ±7%. Check 0 ohm: heater short, ∞ ohm: wire/bimetal open.
R-10-ⓑ	Pantry Sensor Error	Display error: separation of sensor housing, contact error, disconnection, short circuit  Display error by detecting temperature of sensor: more than 149°F (+65°C) or less than -58°F (-50°C)	Check the voltage of MAIN PCB CN30 #8 to #9. It should be between 4.5V to 1.0V.
R-10-ⓐ	Water Tank Heater Error	Display error when open error is detected by water tank heater: separation of water tank heater housing part, contact error, disconnection, short circuit	After separating MAIN PCB CN78 from PCB, check the resistant value between black to brown wire. It should be 45 ohms ±7%. Check 0 ohm: heater short, ∞ ohm: wire/bimetal open.
F-10-ⓐ	Panel to Main Communication Error	Display of Pc/Lc Er in the panel with alarm:	It is desirable to recheck the condition with the oscilloscope after replacing Main and Panel PCBs
F-10-ⓕ	Load to Main Communication Error	MICOM MAIN to LOAD communication error MICOM MAIN to PANEL communication error	

Sensor Resistance / Voltage Checks Table

°C	°F	Voltage	Ohms	°C	°F	Voltage	Ohms	°C	°F	Voltage	Ohms
-50	-58	4.694	153319	-5	23	3.107	16419	40	104	1.153	2997
-49	-56.2	4.677	144794	-4	24.8	3.057	15731	41	105.8	1.124	2899
-48	-54.4	4.659	136798	-3	26.6	3.006	15076	42	107.6	1.095	2805
-47	-52.6	4.641	129294	-2	28.4	2.955	14452	43	109.4	1.068	2714
-46	-50.8	4.622	122248	-1	30.2	2.904	13857	44	111.2	1.040	2627
-45	-49	4.602	115631	0	32	2.853	13290	45	113	1.014	2543
-44	-47.2	4.581	109413	1	33.8	2.802	12749	46	114.8	0.988	2462
-43	-45.4	4.560	103569	2	35.6	2.751	12233	47	116.6	0.963	2384
-42	-43.6	4.537	98073	3	37.4	2.700	11741	48	118.4	0.938	2309
-41	-41.8	4.514	92903	4	39.2	2.649	11271	49	120.2	0.914	2237
-40	-40	4.490	88037	5	41	2.599	10823	50	122	0.891	2167
-39	-38.2	4.465	83456	6	42.8	2.548	10395	51	123.8	0.868	2100
-38	-36.4	4.439	79142	7	44.6	2.498	9986	52	125.6	0.846	2036
-37	-34.6	4.412	75077	8	46.4	2.449	9596	53	127.4	0.824	1973
-36	-32.8	4.385	71246	9	48.2	2.399	9223	54	129.2	0.803	1913
-35	-31	4.356	67634	10	50	2.350	8867	55	131	0.783	1855
-34	-29.2	4.326	64227	11	51.8	2.301	8526	56	132.8	0.762	1799
-33	-27.4	4.296	61012	12	53.6	2.253	8200	57	134.6	0.743	1745
-32	-25.6	4.264	57977	13	55.4	2.205	7888	58	136.4	0.724	1693
-31	-23.8	4.232	55112	14	57.2	2.158	7590	59	138.2	0.706	1642
-30	-22	4.199	52406	15	59	2.111	7305	60	140	0.688	1594
-29	-20.2	4.165	49848	16	60.8	2.064	7032	61	141.8	0.670	1547
-28	-18.4	4.129	47431	17	62.6	2.019	6771	62	143.6	0.653	1502
-27	-16.6	4.093	45146	18	64.4	1.974	6521	63	145.4	0.636	1458
-26	-14.8	4.056	42984	19	66.2	1.929	6281	64	147.2	0.620	1416
-25	-13	4.018	40938	20	68	1.885	6052	65	149	0.604	1375
-24	-11.2	3.980	39002	21	69.8	1.842	5832	66	150.8	0.589	1335
-23	-9.4	3.940	37169	22	71.6	1.799	5621	67	152.6	0.574	1297
-22	-7.6	3.899	35433	23	73.4	1.757	5419	68	154.4	0.560	1260
-21	-5.8	3.858	33788	24	75.2	1.716	5225	69	156.2	0.546	1225
-20	-4	3.816	32230	25	77	1.675	5039	70	158	0.532	1190
-19	-2.2	3.773	30752	26	78.8	1.636	4861	71	159.8	0.519	1157
-18	-0.4	3.729	29350	27	80.6	1.596	4690	72	161.6	0.506	1125
-17	1.4	3.685	28021	28	82.4	1.558	4526	73	163.4	0.493	1093
-16	3.2	3.640	26760	29	84.2	1.520	4369	74	165.2	0.481	1063
-15	5	3.594	25562	30	86	1.483	4218	75	167	0.469	1034
-14	6.8	3.548	24425	31	87.8	1.447	4072	76	168.8	0.457	1006
-13	8.6	3.501	23345	32	89.6	1.412	3933	77	170.6	0.446	978
-12	10.4	3.453	22320	33	91.4	1.377	3799	78	172.4	0.435	952
-11	12.2	3.405	21345	34	93.2	1.343	3670	79	174.2	0.424	926
-10	14	3.356	20418	35	95	1.309	3547	80	176	0.414	902
-9	15.8	3.307	19537	36	96.8	1.277	3428	81	177.8	0.404	877
-8	17.6	3.258	18698	37	98.6	1.253	3344	82	179.6	0.394	854
-7	19.4	3.208	17901	38	100.4	1.213	3204	83	181.4	0.384	832
-6	21.2	3.158	17142	39	102.2	1.183	3098	84	183.2	0.375	810

**Note:** When performing diagnostic checks, verify connector and pin numbers on the diagram packed with the unit.

### Sensor Resistance / Voltage Checks

#### Ice Maker Sensor

Resistance Check (CN90 Unplugged)

CN90 Pin# 4 to Pin# 8

Voltage Check (CN90 Connected)

CN90 Pin# 4 to CN10 Pin# 3

#### Ice Maker Sensor Error Code



#### Refrigerator Sensor

Resistance Check (CN30 Unplugged)

CN30 Pin# 6 to CN10 Pin# 3

Voltage Check (CN30 Connected)

CN30 Pin# 6 to CN10 Pin# 3

#### Refrigerator Sensor Error Code



#### Refrigerator Defrost Sensor

Resistance Check (CN30 Unplugged)

CN30 Pin# 7 to CN10 Pin# 3

Voltage Check (CN30 Connected)

CN30 Pin# 7 to CN10 Pin# 3

#### Refrigerator Defrost Sensor Error Code



#### Ambient Sensor

Resistance Check (CN32 Unplugged)

CN32 Pin# 1 to CN32 Pin# 4

Voltage Check (CN32 Connected)

CN32 Pin# 1 to CN10 Pin# 3

#### Ambient Sensor Error Code



### Freezer Sensor

Resistance Check (CN30 Unplugged)

CN30 Pin# 3 to CN10 Pin# 3

Voltage Check (CN30 Connected)

CN30 Pin# 3 to CN10 Pin# 3

#### Freezer Sensor Error Code



### Ice Room Sensor

Resistance Check (CN32 Unplugged)

CN32 Pin# 3 to CN10 Pin# 3

Voltage Check (CN32 Connected)

CN32 Pin# 3 to CN10 Pin# 3

#### Ice Room Sensor Error Code



### Freezer Defrost Sensor

Resistance Check (CN30 Unplugged)

CN30 Pin# 4 to CN10 Pin# 3

Voltage Check (CN32 Connected)

CN30 Pin# 4 to CN10 Pin# 3

#### Freezer Defrost Sensor Error Code



### Pantry Sensor

Resistance Check (CN30 Unplugged)

CN30 Pin# 8 to CN30 Pin# 9

Voltage Check (CN30 Connected)

CN30 Pin# 8 to CN10 Pin# 3

#### Pantry Sensor Error Code





## Operational Fan Checks

Note: All fan voltage checks are from CN10 Pin# 3.

Check voltage to fans:

Freezer Fan – CN75 Pin#2 7 to 12 VDC

Refrigerator Fan – CN75 Pin#3 7 to 12 VDC

Condenser Fan – CN75 Pin#4 7 to 12 VDC

Check voltage from fans (indicates fans are turning):

Freezer Fan – CN75 Pin#5 2 to 3 VDC

Refrigerator Fan – CN75 Pin#6 2 to 3 VDC

Condenser Fan – CN75 Pin#7 2 to 3 VDC

### Freezer Fan Strip Circuit

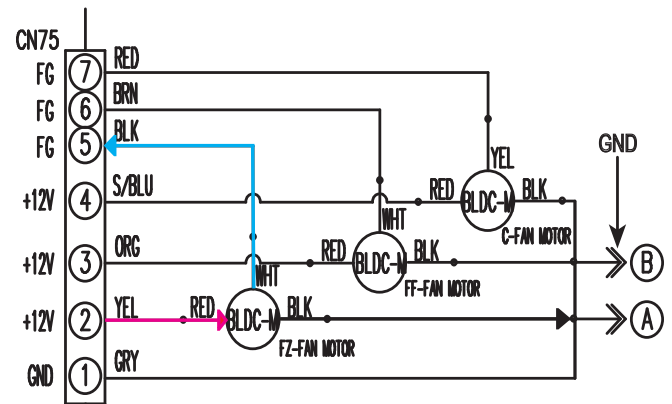

### Refrigerator Fan Error Code



### Freezer Fan Error Code



### Condenser Fan Error Code



### Refrigerator Fan Strip Circuit

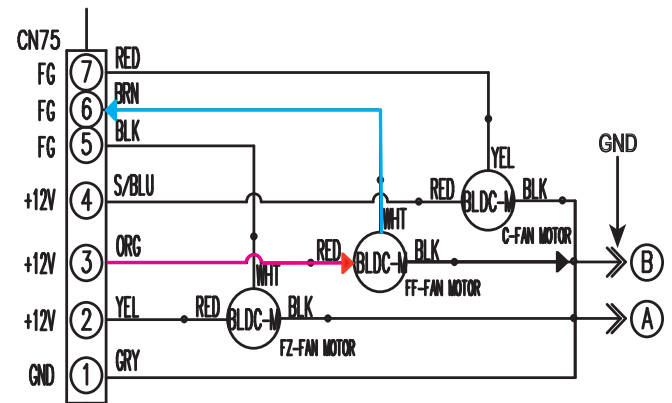

### Condenser Fan Strip Circuit

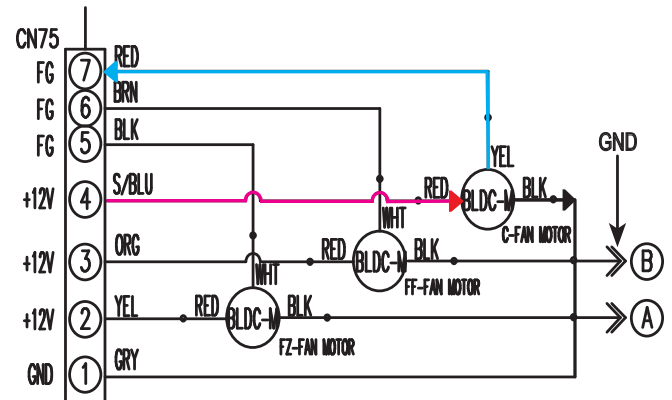

## Ice Room Fan Checks

Note: All fan voltage checks are from CN10 Pin# 3

Check voltage to fan:

Ice Room Fan – CN76 Pin#1 7 to 12 VDC

Check voltage from fan (indicates fans are turning):

Ice Room Fan – CN76 Pin#2 2 to 3 VDC

### Ice Room Fan Error Code

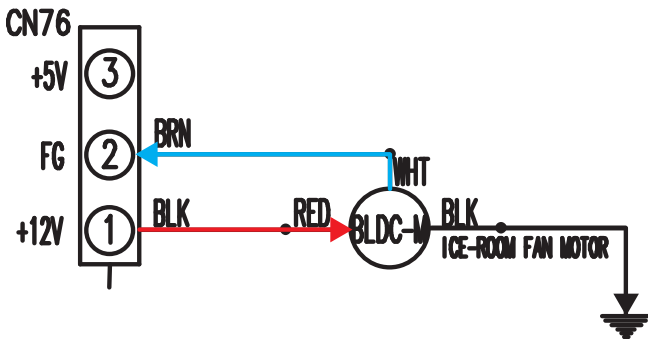

## Pantry Room Damper Heater

With CN91 unplugged from the board, read resistance between pins 1 and 2 of plug.

Heater should read approximately 145 ohms.

When the heater is energized, there should be approximately 12VDC between pins 1 and 2 of CN91. (Plug connected to board)

### Pantry Room Damper Heater Error Code

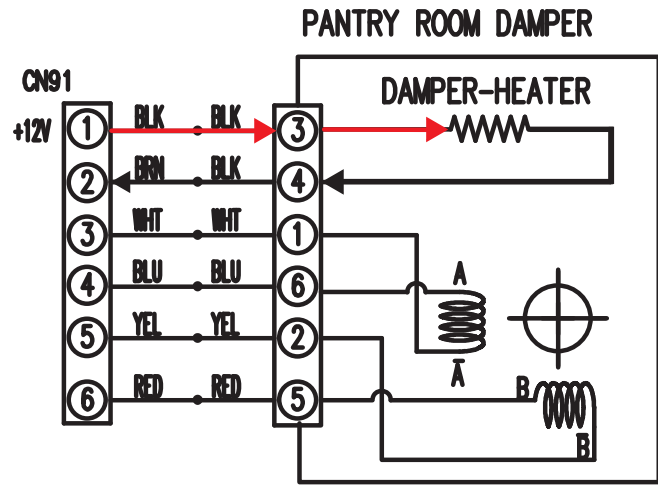

## Water Tank Heater

With CN78 unplugged from the board, read resistance between pins 4 and 5 of plug.

Heater should read approximately 75 ohms. When heater is energized, there should be approximately 12VDC between pins 4 and 5 of CN78. (Plug connected to board)

## Water Tank Heater Error Code

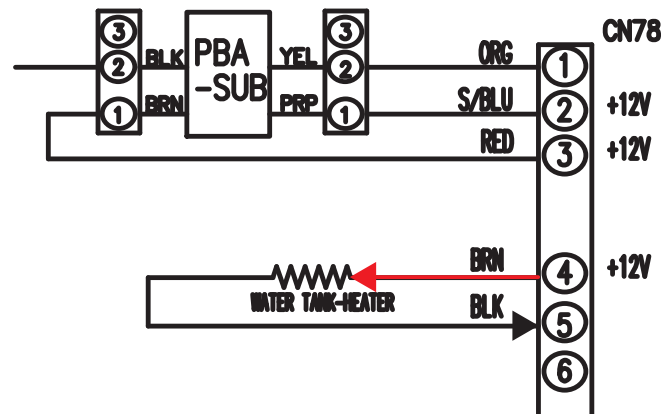

## Defrost Heaters

### Freezer Defrost Heater

The Freezer Defrost Heater has a resistance value of approximately  $56 \Omega$  and is in a parallel circuit with the duct heater. (See *Duct Heater*.)

Disconnect CN70 from the board. Check for a combined resistance of  $55 \Omega$  between pin 9 to CN71 pin 9, when the defrost safety thermostat is closed. A reading of approximately  $3.18K \Omega$  will indicate an open freezer defrost heater, wiring, or connection.

### Freezer Defrost Heater Error Code



### Freezer Defrost Heater Circuit

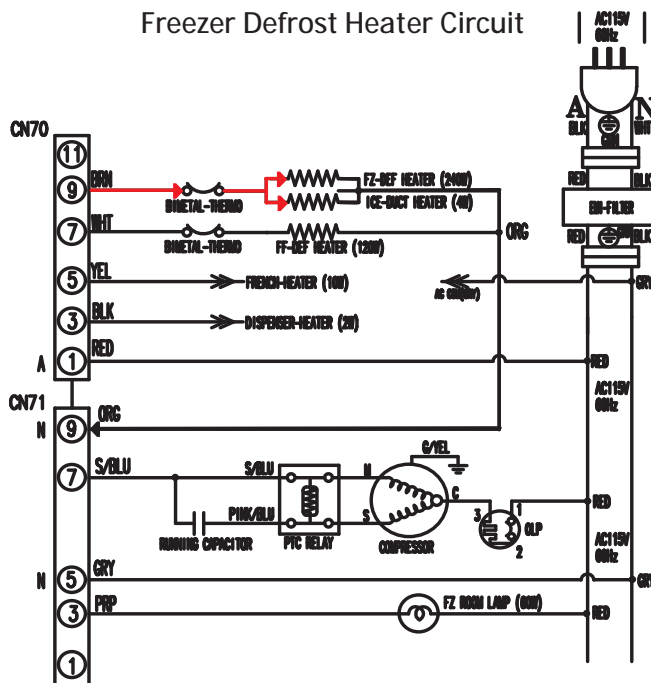

### Refrigerator Defrost Heater

With CN70 unplugged from the board, read resistance between pin 7 to CN71 pin 9. Refrigerator Defrost Heater should read approximately 120 ohms.

### Refrigerator Defrost Heater Error Code



### Refrigerator Defrost Heater Circuit

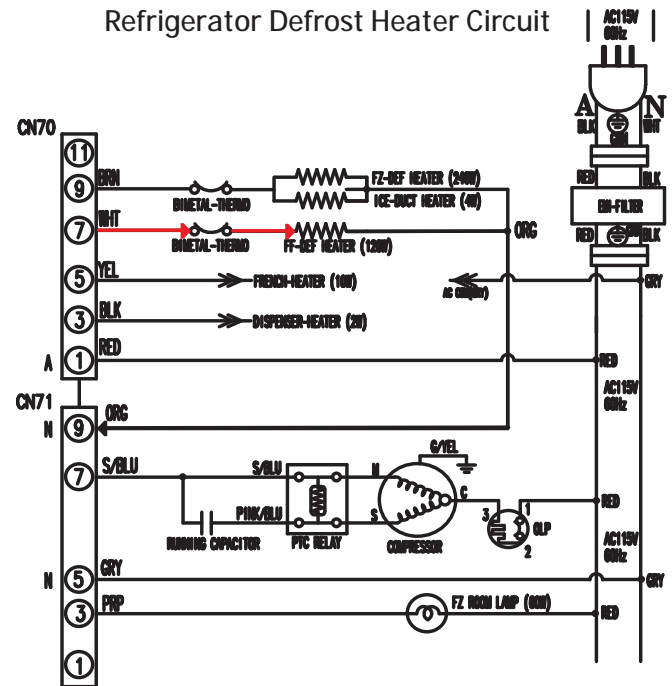

Note: To functionally test the defrost heaters, energize the heaters by using the test mode. (See *Test Mode Operation*.)

### Compressor

Note: There is a 5-minute delay start with a cold cabinet.

The compressor utilizes a "Switched Neutral" circuit. The L1 side is always "hot".

Read between CN1 pin# 1 (L1) on power supply board to CN71 pin# 7. Test will show 0 VAC, if board wants compressor to run.



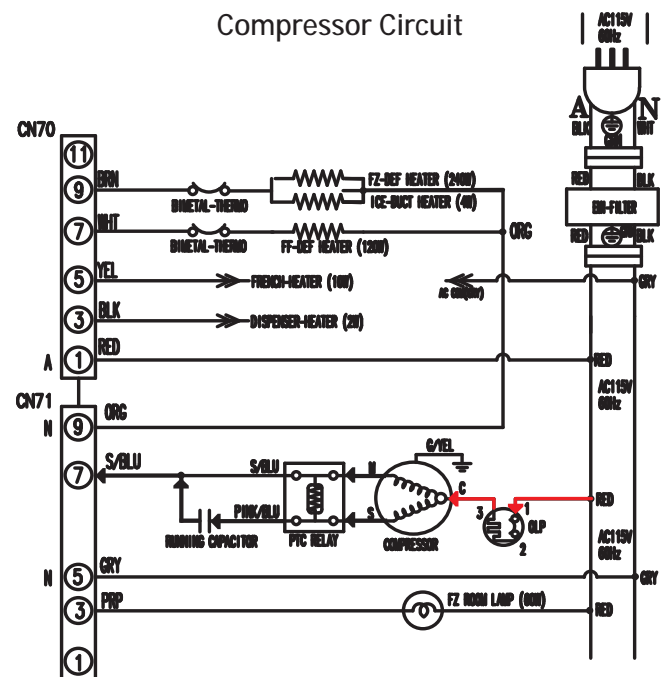

### Compressor Circuit

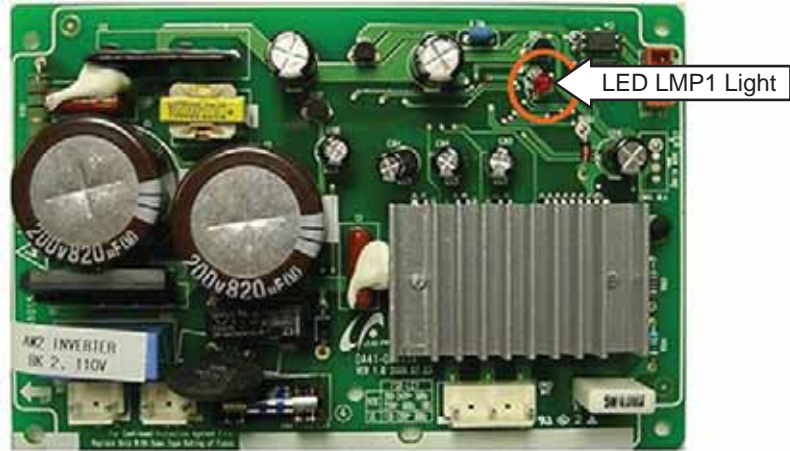

## Inverter Board Compressor Codes

The inverter board has an LED "LMP1" light on the board. This LED is the status of the compressor operation. In normal run, the LED will be on steady. When the compressor turns off, this light will be off also. In the event of a compressor or inverter board failure, the LED will blink providing you with the failure code.



LED Blinking Frequency	Protecting Functions	Remarks
	Normal Operation	Continuously ON
	Starting Failure	Check the Inverter PCB connector and Comp relay connector
	SPM Fault	If the same blinking after reset unit, It is defective Inverter PCB
	Detecting Position Failure	Check the Inverter PCB connector →If the same blinking after reset unit, It is defective Inverter PCB
	Motor locked	Compressor locking

# Schematic

**Note:** This schematic applies to both the LED and the LCD models. When performing diagnostic checks, verify connector and pin numbers on the diagram packed with the unit.

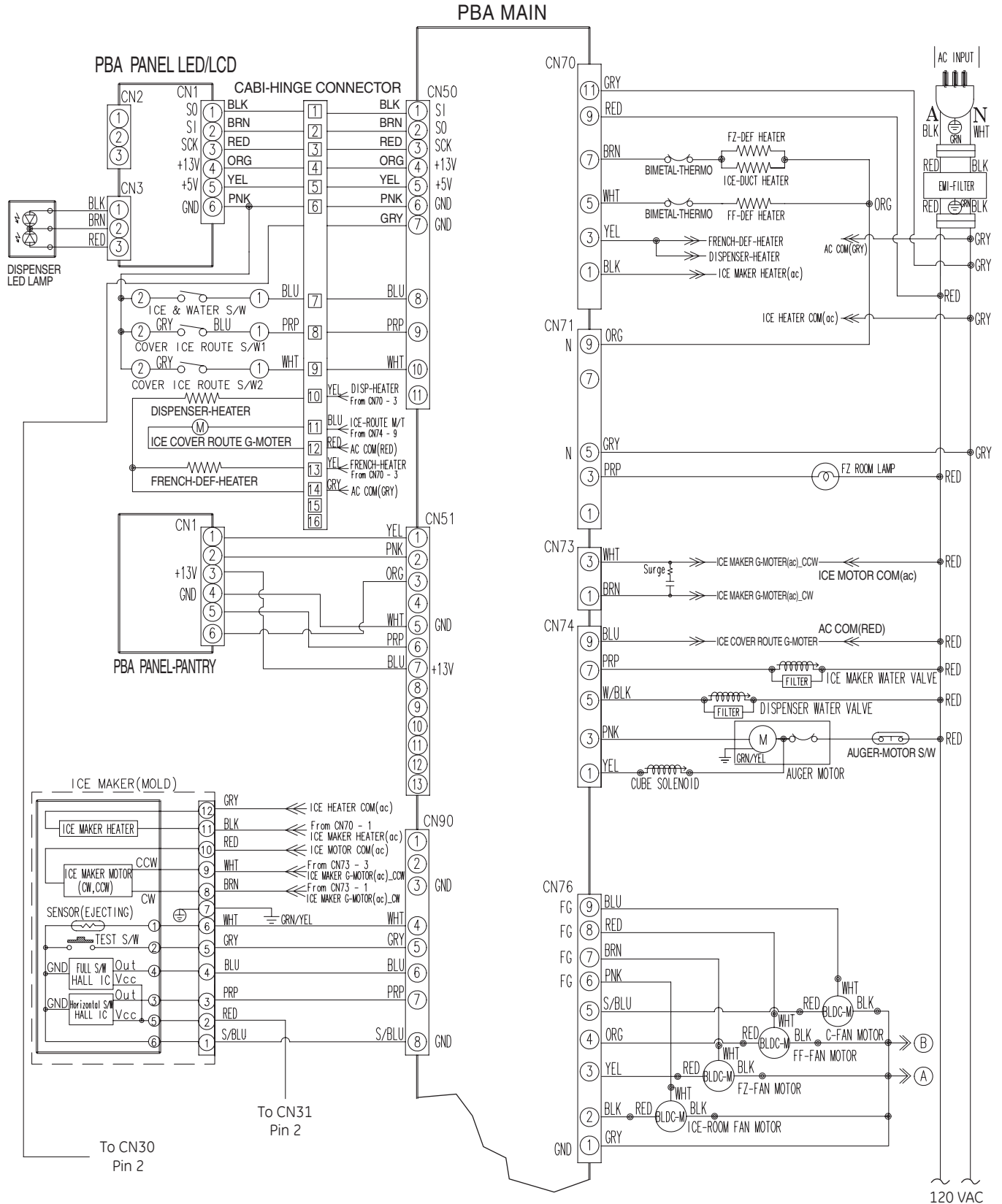



Schematic (Continued)

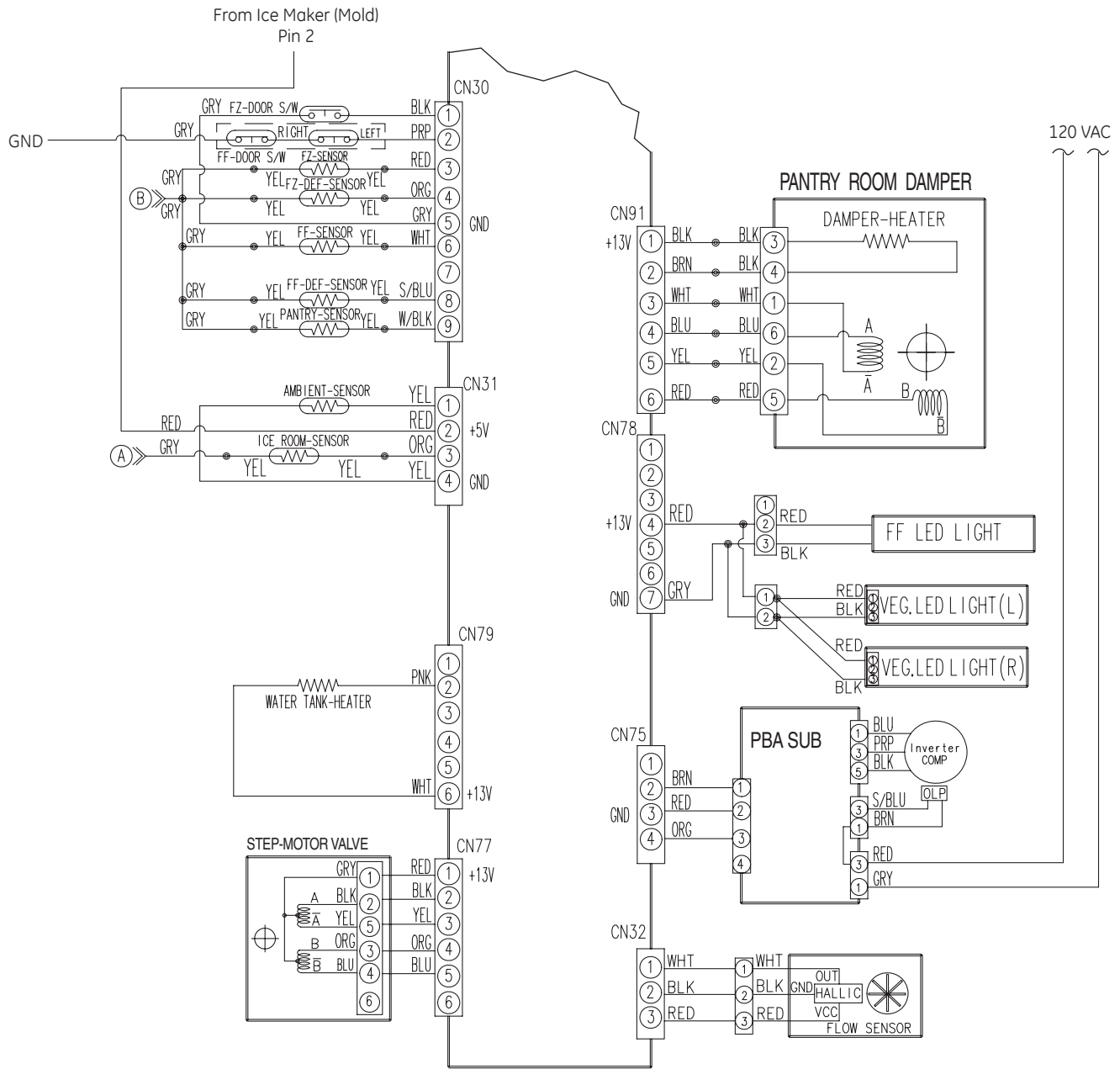

# Warranty

## Refrigerator Warranty. *(For customers in the United States)*



All warranty service provided by our Factory Service Centers, or an authorized Customer Care® technician. To schedule service, on-line, 24 hours a day, visit us at [ge.com](http://ge.com), or call 800.GE.CARES (800.432.2737). Please have serial number and model number available when calling for service.

Staple your receipt here.  
Proof of the original purchase date is needed to obtain service under the warranty.

### For The Period Of: **GE Will Replace:**

#### GE and GE PROFILE MODELS:

##### **One Year**

From the date of the original purchase

**Any part** of the refrigerator which fails due to a defect in materials or workmanship. During this **limited one-year warranty**, GE will also provide, **free of charge**, all labor and related service to replace the defective part.

##### **Thirty Days**

(Water filter, if included)  
From the original purchase date of the refrigerator

**Any part** of the water filter cartridge which fails due to a defect in materials or workmanship. During this **limited thirty-day warranty**, GE will also provide, **free of charge**, a replacement water filter cartridge.

#### GE PROFILE MODELS ONLY:

##### **Five Years**

(GE Profile models only)  
From the date of the original purchase

**Any part of the sealed refrigerating system** (the compressor, condenser, evaporator and all connecting tubing) which fails due to a defect in materials or workmanship. During this **limited five-year sealed refrigerating system warranty**, GE will also provide, **free of charge**, all labor and related service to replace the defective part in the sealed refrigerating system.

### What GE Will Not Cover:

- Service trips to your home to teach you how to use the product.
- Improper installation, delivery or maintenance.
- Failure of the product if it is abused, misused, or used for other than the intended purpose or used commercially.
- Loss of food due to spoilage.
- Replacement of house fuses or resetting of circuit breakers.
- Damage caused after delivery.
- Replacement of the water filter cartridge, if included, due to water pressure that is outside the specified operating range or due to excessive sediment in the water supply.
- Replacement of the light bulbs, if included, or water filter cartridge, if included, other than as noted above.
- Damage to the product caused by accident, fire, floods or acts of God.
- Incidental or consequential damage caused by possible defects with this appliance.
- Product not accessible to provide required service.

**EXCLUSION OF IMPLIED WARRANTIES—Your sole and exclusive remedy is product repair as provided in this Limited Warranty. Any implied warranties, including the implied warranties of merchantability or fitness for a particular purpose, are limited to one year or the shortest period allowed by law.**

This warranty is extended to the original purchaser and any succeeding owner for products purchased for home use within the USA. If the product is located in an area where service by a GE Authorized Servicer is not available, you may be responsible for a trip charge or you may be required to bring the product to an Authorized GE Service location for service. In Alaska, the warranty excludes the cost of shipping or service calls to your home.

# CUSTOMER WARRANTY

(for customers in Canada)

Your refrigerator is warranted to be free of defects in material and workmanship.

What is covered	How Long Warranted (From Date of Sale)	Parts Repair or Replace at Mabe's Option	Labour
Compressor	GE Profile: Ten (10) Years GE and All Other Brands: One (1) Year	GE Profile: Ten (10) Years GE and All Other Brands: One (1) Year	GE Profile: Five (5) Years GE and All Other Brands: One (1) Year
Sealed System (including evaporator, condenser tubing and refrigerant)	GE Profile: Five (5) Years GE and All Other Brands: One (1) Year	GE Profile: Five (5) Years GE and All Other Brands: One (1) Year	GE Profile: Five (5) Years GE and All Other Brands: One (1) Year
All Other Parts	One (1) Year	One (1) Year	One (1) Year

## TERMS AND CONDITIONS:

This warranty applies only for single family domestic use in Canada when the Refrigerator has been properly installed according to the instructions supplied by Mabe and is connected to an adequate and proper utility service.

Damage due to abuse, accident, commercial use, and alteration or defacing of the serial plate cancels all obligations of this warranty.

Service during this warranty period must be performed by an Authorized Mabe Service Agent.

Neither Mabe nor the Dealer is liable for any claims or damages resulting from failure of the Refrigerator or from service delays beyond their reasonable control.

To obtain warranty service, purchaser must present the original Bill of Sale. Components repaired or replaced are warranted through the remainder of the original warranty period only.

This warranty is extended to the original purchaser and any succeeding owner for products purchased for home use within Canada. In home warranty service will be provided in areas where it is available and deemed reasonable by Mabe to provide.

This warranty is in addition to any statutory warranty.

## WHAT IS NOT COVERED:

- Owner is responsible to pay for service calls related to product installation and/or teaching how to use the product.
- Damage to finish must be reported within 48 hours following the delivery of the appliance.
- Damage to finish after delivery.
- Improper installation—proper installation includes adequate air circulation to the refrigeration system, adequate electrical, plumbing and other connecting facilities.
- Replacement of house fuses or resetting of circuit breakers.
- Replacement of light bulbs.
- Damage to product caused by accident, fire, floods or acts of God.
- Loss of food due to spoilage.
- Proper use and care of product as listed in the owner's manual, proper setting of controls.
- Product not accessible to provide required service.
- WARRANTOR IS NOT RESPONSIBLE FOR CONSEQUENTIAL DAMAGES.

***EXCLUSION OF IMPLIED WARRANTIES—Your sole and exclusive remedy is product repair as provided in this Limited Warranty. Any implied warranties, including the implied warranties of merchantability or fitness for a particular purpose, are limited to one year or the shortest period allowed by law.***

## IMPORTANT

**Keep this warranty and your bill of sale as proof of original purchase and purchase date. Please have serial number and model number available when calling for service.**

Mabe Service is available coast to coast. If further help is needed concerning this warranty, contact:

Manager, Consumer Relations  
Mabe Canada Inc., Consumer Service  
1 Factory Lane, Suite 310  
Moncton, New Brunswick E1C 9M3  
1.800.561.3344

*Staple your receipt here.  
Proof of the original purchase  
date is needed to obtain service  
under the warranty.*