

GE Consumer & Industrial

Technical Service Guide

June 2007

Profile Side-By-Side Refrigerators

PSF26PGWBB
PSS26PSWSS
PSC25PSWSS
PSW26RSWSS

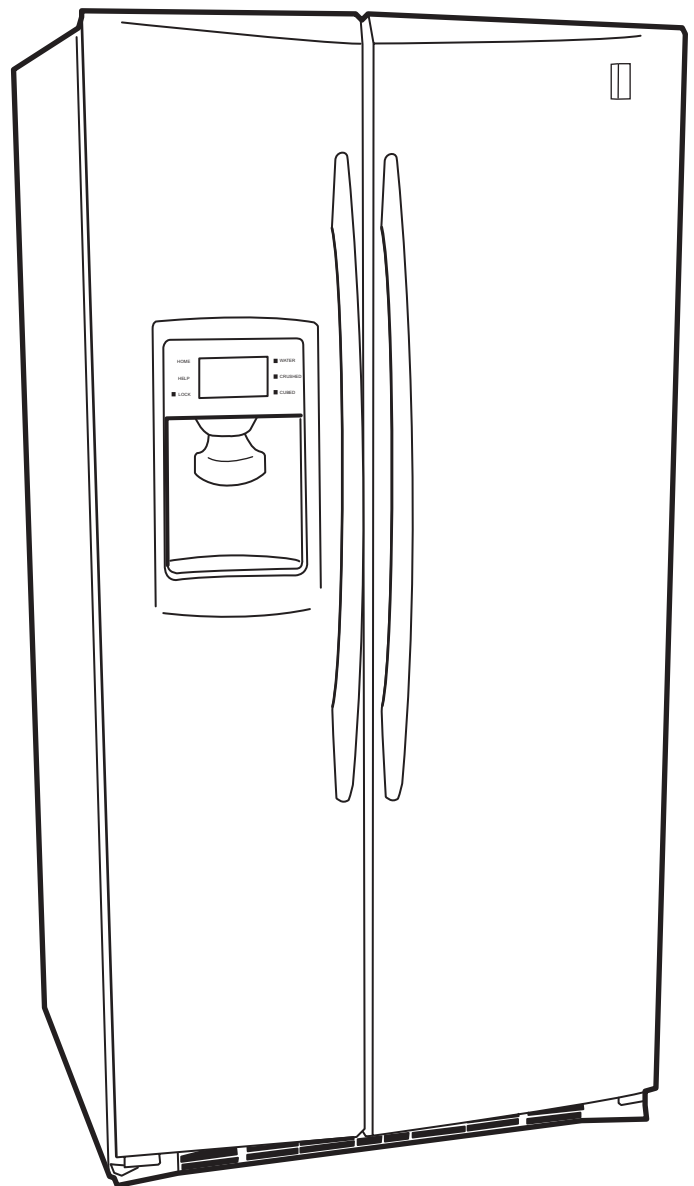

31-9153



GE Appliances
General Electric Company
Louisville, Kentucky 40225



IMPORTANT SAFETY NOTICE

The information in this service guide is intended for use by individuals possessing adequate backgrounds of electrical, electronic, and mechanical experience. Any attempt to repair a major appliance may result in personal injury and property damage. The manufacturer or seller cannot be responsible for the interpretation of this information, nor can it assume any liability in connection with its use.

WARNING

To avoid personal injury, disconnect power before servicing this product. If electrical power is required for diagnosis or test purposes, disconnect the power immediately after performing the necessary checks.

RECONNECT ALL GROUNDING DEVICES

If grounding wires, screws, straps, clips, nuts, or washers used to complete a path to ground are removed for service, they must be returned to their original position and properly fastened.

GE Consumer & Industrial

Technical Service Guide

Copyright © 2007

All rights reserved. This service guide may not be reproduced in whole or in part in any form without written permission from the General Electric Company.

Table of Contents

3-Way Valve	40
Beverage Center Blower Motor	30
Check Valve	29
Components	25
Components Locator Views	20
Condenser Fan	32
Control Board Connector Locator	52
Control Diagnostics Using LCD Screen	49
Control Features	8
CustomCool™ Assembly	44
Defrost Cycles	35
Dispenser Assembly	46
Evacuation and Charging Procedure	24
Freezer Evaporator	25
Freezer Evaporator Fan	31
Freezer Section Cooling	22
Fresh Food and Freezer Section Cooling	23
Fresh Food Evaporator	28
Fresh Food Evaporator Fan	29
Fresh Food Section Cooling	22
Icemaker Service Test Mode	63
Introduction	4
Inverter	37
Inverter Compressor	38
Nomenclature	7
Precise Fill	47
Precise Fill Troubleshooting	62
QuickFreeze™ Fan Motor	32
Refrigeration System	22
Replacing the 3-Way Valve	42
Schematic	64
Single-Speed Compressor	39
Technical Data	6
Thermistors	34
Troubleshooting	49
Warranty	66

Introduction

*This new Profile Side by Side dual evaporator refrigerator has the following features:

- New integrated dispenser with LED lighting, child lock, and door alarm combined with LCD screen provides customer control of temperatures and features presented in computer-style menus.
- Separate freezer and fresh food evaporators with independent cooling.
- No damper/air inlet assembly in the fresh food section creates more usable space on the top shelf.
- Greater fresh food humidity to keep food fresher, longer.
- 20% less freezer defrost for better food preservation.
- 3-way valve to direct refrigerant flow.
- Nearly silent, only 30 dBA.
- Precise Fill technology dispenses fresh, filtered water in accurate measurements.
- QuickFreeze™ — Freeze items 2 times faster to enhance food preservation. During normal freezing, ice crystals form in the shape of needles that puncture the cell walls of meat. Punctured cell walls lose fluid during defrosting thus losing nutrients and freshness. The QuickFreeze option freezes the cell walls before ice needles develop.
- Quick Ice — Increases ice production by approximately 40%.
- TurboCool™ — Rapidly cools the refrigerator compartment in order to more quickly cool foods.
- CustomCool™ — Quickly chill, thaw, or hold items at a specific temperature.
- Electronic Beverage Center — Keeps beverages and treats icy cold and easily accessible.
- GE Reveal® Lighting — Casts a clean, beautiful light throughout the refrigerator.



The 3-speed compressor* is controlled by an inverter that receives input from the low voltage DC side of the main control board. The inverter always has 120 VAC applied when the refrigerator is connected to power. The main control board still makes compressor decisions based on the input of thermistors, door-open time, and input from the LCD display. The main control also operates all other electrical components in the refrigerator such as the water valve, fan motors, lights, etc.

* Features may vary by model.

About ClimateKeeper™

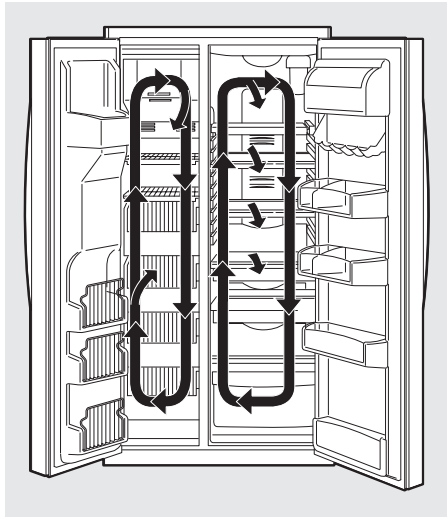

How it Works

The **ClimateKeeper2™** is the industry's most advanced refrigeration system, delivering optimum temperature and humidity performance to keep food garden fresh longer and reduce freezer burn, while maintaining E star-level efficiency.

The **ClimateKeeper2** system features two evaporators—one for the refrigerator and one for the freezer. This provides two separate cooling systems, and separates

the airflow between the fresh food and freezer compartments during normal cooling operations.*

This ensures that the humidity levels in the fresh food compartment are significantly higher than in a conventional system,** allowing fresh produce and other unsealed foods to retain their moisture content and freshness longer. Moisture sensitive foods such as fresh fruit, salads, rice, etc., can now be stored on open shelves without excessive moisture loss. Due to the higher humidity in the refrigerator, you may on occasion experience fog or small amounts of moisture in the refrigerator compartment. This is normal and may come and go as different food loads and environmental conditions change. Wipe dry with a paper towel if desired.

The separate airflow system minimizes the mixing of air between the two compartments, which reduces fresh food odor transfer to improve the taste of ice. The **ClimateKeeper2** system also reduces the number of defrosting cycles in the freezer evaporator, thereby reducing freezer burn.

*Freezer air is used in the **CustomCool™** feature.

Testing shows a higher level of humidity in the Fresh Food section in **ClimateKeeper2 refrigerators versus conventional units.

Technical Data

DISCONNECT POWER CORD BEFORE SERVICING

IMPORTANT - RECONNECT ALL GROUNDING DEVICES

All parts of this appliance capable of conducting electrical current are grounded. If grounding wires, screws, straps, clips, nuts or washers used to complete a path to ground are removed for service, they must be returned to their original position and properly fastened.

ELECTRICAL SPECIFICATIONS

Temperature Control (Position 5)	7-(-11)°F
Defrost Control	60hrs @ 45 min w/ no door openings
Overtemperature Thermostat	140-110°F
Defrost Thermistor	70°F
Electrical Rating: 115V AC 60 Hz	11.6 Amp
Maximum Current Leakage	0.75 mA
Maximum Ground Path Resistance	0.14 Ohms

NO LOAD PERFORMANCE

Control Position MID/MID and Ambient of:	70°F	90°F
Fresh Food, °F	34-40	34-40
Frozen Food, °F	(-3) 3	(-3) 3
Run Time, %	@ 70 = 43%	@ 90 = 69%

REFRIGERATION SYSTEM

Refrigerant Charge (R134a)	5.0 ounces
Compressor	715 BTU/hr
Minimum Compressor Capacity	22 inches
Minimum Equalized Pressure	
@ 70°F	40 PSIG
@ 90°F	52 PSIG

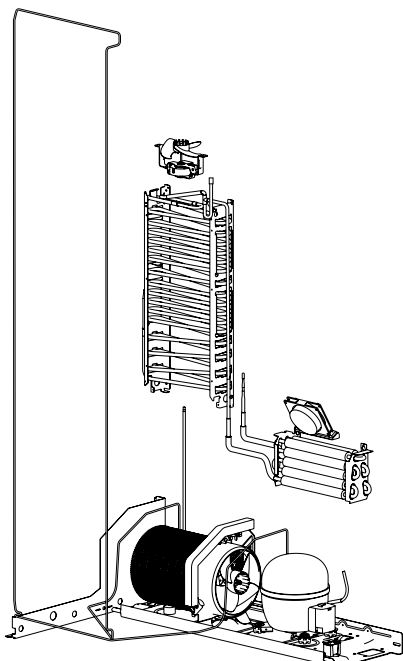

IMPORTANT SAFETY NOTICE

This information is intended for use by individuals possessing adequate backgrounds of electrical, electronic and mechanical experience. Any attempt to repair a major appliance may result in personal injury and property damage. The manufacturer or seller cannot be responsible for the interpretation of this information, nor can it assume any liability in connection with its use.

INSTALLATION

Minimum clearance required for air circulation:

TOP	1"
SIDES	0.125"
REAR	0.5"

AIR FLOW

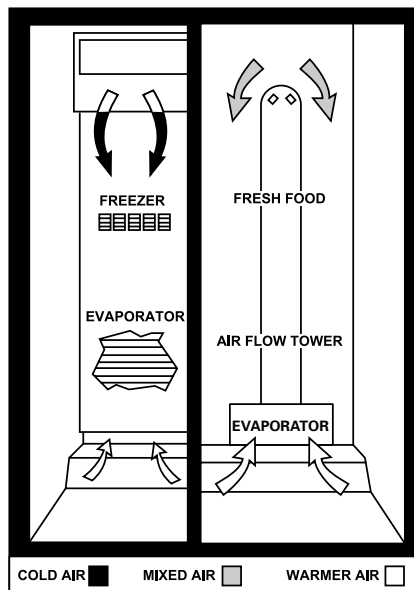
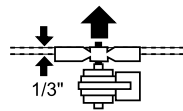

Nomenclature

P S F 26 P G W B B

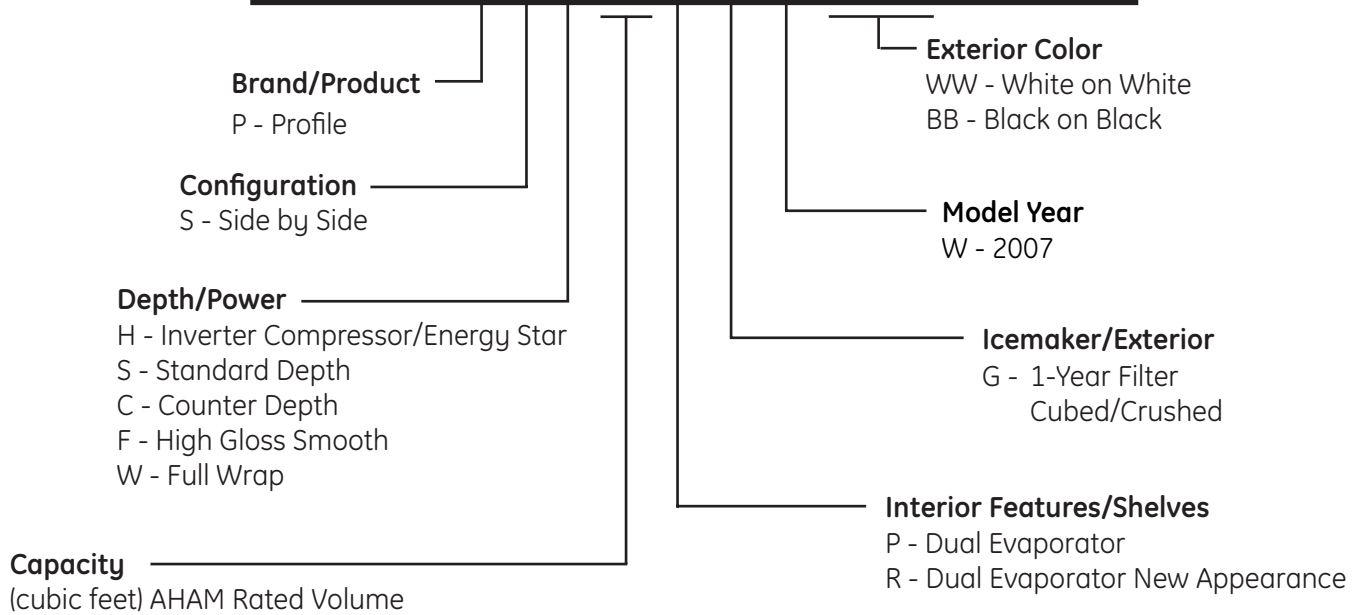

The nomenclature plate is located on the upper right wall of the fresh food compartment. It contains the following information:

Nomenclature



Mini-Manual Location

- Model and Serial Number
- Minimum Installation Clearances
- Electrical Voltage, Frequency
- Maximum Amperage Rating
- Refrigerant Charge and Type

Serial Number

The first two numbers of the serial number identify the month and year of manufacture.

Example: **AM**123456S = January, 2007

A - JAN	2007 - M
D - FEB	2006 - L
F - MAR	2005 - H
G - APR	2004 - G
H - MAY	2003 - F
L - JUN	2002 - D
M - JUL	2001 - A
R - AUG	2000 - Z
S - SEP	1999 - V
T - OCT	1998 - T
V - NOV	1997 - S
Z - DEC	1996 - R

The letter designating the year repeats every 12 years.

Example:
T - 1974
T - 1986
T - 1998

The Mini-Manual is located behind the base grill and taped under the cabinet.

Control Features

About the home screen

Not all features are on all models.



Note: The refrigerator is shipped with protective film covering the controls. If this film was not removed during installation, remove it now.

The Home screen is the initial screen presented after power-up. The status bar at the top displays the status of many of the refrigerator features. Freezer and Refrigerator sections display present compartment temperatures.

- Press displayed set temperatures. Set temperatures then can be changed.
- Press the light icon to operate the dispenser LED.
- Press Options to provide access to Freezer, Refrigerator, and Dispenser options as well as access to Information and Settings.



About the temperature controls

The temperature controls are preset in the factory at 37°F(3°C) for the refrigerator compartment and 0°F (-18°C) for the freezer compartment. Allow 24 hours for the temperature to stabilize to the preset recommended settings.

Refrigerator temperatures can be adjusted between 34°F and 46°F (1°C to 8°C), and the freezer temperatures can be adjusted between -6°F and +6°F (-21°C to -14°C).

To change the Refrigerator temperature:

Access By: Home > Refrigerator

Activate By: Using the arrows to select the desired temperature. You must press **ENTER** to set the new temperature.



(Continued next page)

To change the Freezer temperature:

Access By: Home > Freezer

Activate By: Using the arrows to select the desired temperature. You must press **ENTER** to set the new temperature.

Once the desired temperature has been set, the display will return to the **HOME** screen and show the set temperatures underneath the actual temperature display for several seconds. Several adjustments may be required. Each time you adjust the controls, allow 24 hours for the refrigerator to reach the temperature you have set.

The temperature controls can display both the **SET** temperature as well as the actual temperature in the refrigerator and freezer. The actual temperature may vary slightly from the **SET** temperature based on usage and operating environment.



Options

Use options to access Refrigerator Options, Freezer Options, Dispenser Options, and Information and Settings menus. Access by: Home> Options.

- Press Freezer Options to access QuickIce and QuickFreeze.
- Press Refrigerator Options to access CustomCool, TurboCool, and Beverage Center.
- Press Dispenser Options to access Precise Fill and Reset Water Filter.
- Press Information and Settings to access Settings, Screen Appearance, and Feature Info.



Quick Ice

When you need to speed up ice production, use the **Quick Ice** feature. While this feature is turned on, the freezer fan runs continuously for 48 hours, or until the feature is turned OFF. During this period, ice production will increase up to 40% (up to 2 lbs/day). Models with the integrated ice feature system require at FIRST USE at least half an 8 oz. glass of ice to be dispensed every 6 to 12 hours. This will help the icemaker fill the bucket properly so that dispensing is better.

Note: Ice production will vary according to usage conditions, or if the same feature is deactivated earlier.

How to Use

Access by pressing: Home > Options > Freezer Options > Quick Ice. Activate by pressing **ON**. Deactivate by pressing **OFF**.



About QuickFreeze.™ (on some models)

The **QuickFreeze** plate is only to be used with the **QuickFreeze**™ feature. Use **QuickFreeze** to freeze items faster to enhance food preservation.

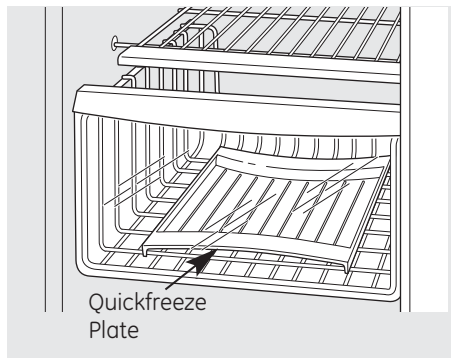

How to Use

Place food (wrapped in plastic wrap) on **QuickFreeze** plate. Turn the feature on via the LCD controls. Access by pressing: Home > Options > FreezerOptions > QuickFreeze. Activate by using the arrows to select the time and pressing **Enter**. Deactivate by pressing **OFF**.

Note:

- While the **QuickFreeze** feature is enabled, the actual freezer temperature may drop as low as -3°F (-19°C). This is normal.
- **QuickFreeze** can operate for 2.5 hours up to 3.25 hours depending on the weight of the food or until you manually turn the feature off.



About CustomCool™ (on some models)

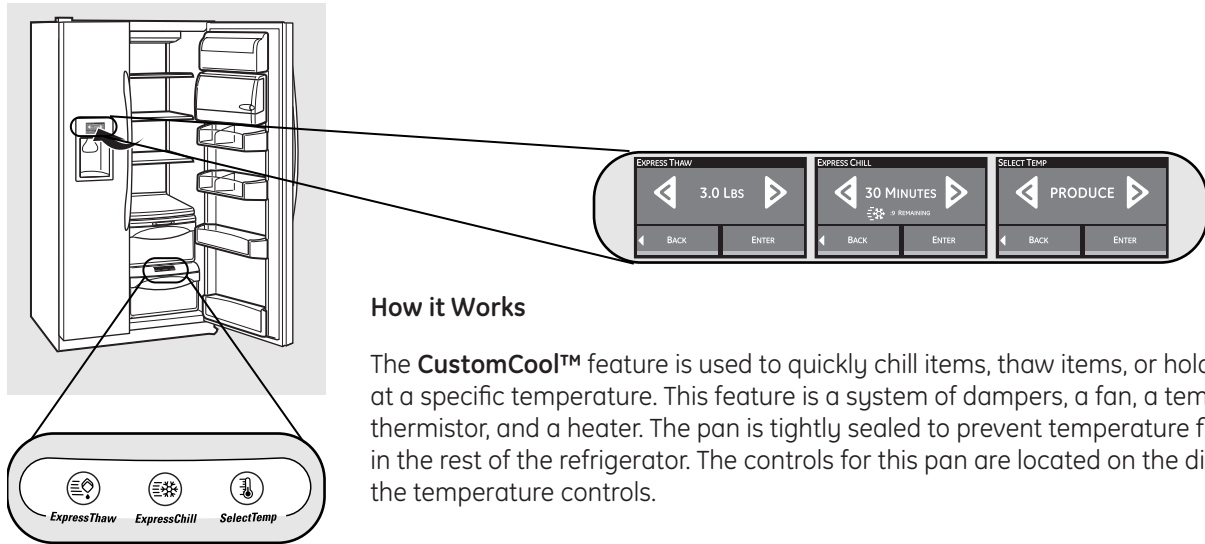

How it Works

The **CustomCool™** feature is used to quickly chill items, thaw items, or hold the pan at a specific temperature. This feature is a system of dampers, a fan, a temperature thermistor, and a heater. The pan is tightly sealed to prevent temperature fluctuations in the rest of the refrigerator. The controls for this pan are located on the dispenser with the temperature controls.

How to Use

Empty the pan. Place the Chill/Thaw tray in the pan. Place the items on the tray and close the pan completely.

Access by: Home > Options > Refrigerator Options > CustomCool Pan



Use the following list to determine the best setting to use.

- On some models, **ExpressChill™** has only one 45 minute setting.
- To stop a feature before it is finished; go into that feature's menu and press the **OFF** button.
- During **ExpressThaw™** and **ExpressChill**, the display on the controls will count down the time in the cycle (on some models).
- After the **ExpressThaw** cycle is complete, the pan will reset to the **MEAT** setting (32°F [0°C]) to help preserve thawed items until they are used.
- The displayed actual temperature of the **CustomCool** pan may vary slightly from the **SET** temperature based on usage and operating environment.

Note: For food safety reasons, it is recommended that foods be wrapped in plastic wrap when using **ExpressThaw**. This will help contain meat juices and improve thawing performance.

How to Remove and Replace the Drawer

To remove: Pull the drawer out to the stop position. Rotate all four swing locks to the unlock position. Lift the front of the drawer up and out.

To replace: Make sure all four swing locks are in the unlock position. Place the sides of the drawer into the drawer supports, making sure the swing locks fit on the drawer slots. Lock all four swing locks by rotating them to the lock position.

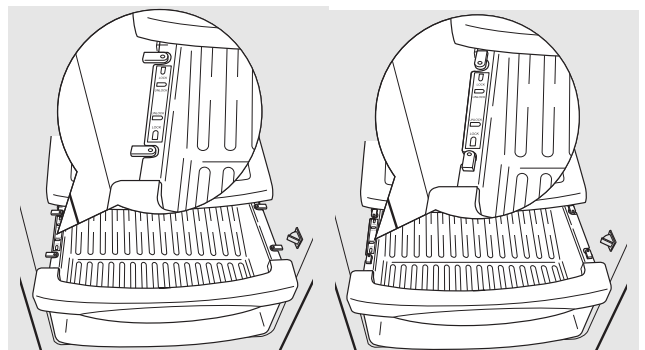

About TurboCool™

How it Works

TurboCool™ rapidly cools the refrigerator compartment in order to more quickly cool foods. Use **TurboCool** when adding a large amount of food to the refrigerator compartment, putting away foods after they have been sitting out at room temperature or when putting away warm leftovers. It can also be used if the refrigerator has been without power for an extended period. Once activated, the compressor will turn on immediately and the fans will cycle on and off at high speed as needed for eight hours. The compressor will continue to run until the refrigerator compartment cools to approximately 34°F (1°C), then it will cycle on and off to maintain this setting. After 8 hours, or if TurboCool is pressed again, the refrigerator compartment will return to the original setting.

How to Use

Access by pressing: Home > Options > Refrigerator Options > TurboCool. Activate by pressing **ON**. Deactivate by pressing **OFF**.



Note: The refrigerator temperature cannot be changed during **TurboCool**. The freezer temperature is not affected during **TurboCool**. When opening the refrigerator door during **TurboCool**, the fans will continue to run if they have cycled on.

How to Use the Beverage Center

Some **CustomCool** models feature a beverage center. It is designed to store beverages at colder temperatures. Select this feature if you like to keep extra-chilled refreshments on hand. Access by pressing Home > Options > Refrigerator Options > Beverage Center. Activate by pressing **ON**. Deactivate by pressing **OFF**.

Note: Unless turned off as above, feature will remain active for six months. Press the **Beverage Center** pad to restart.



How to Remove and Replace the Beverage Center

Dairy Bin

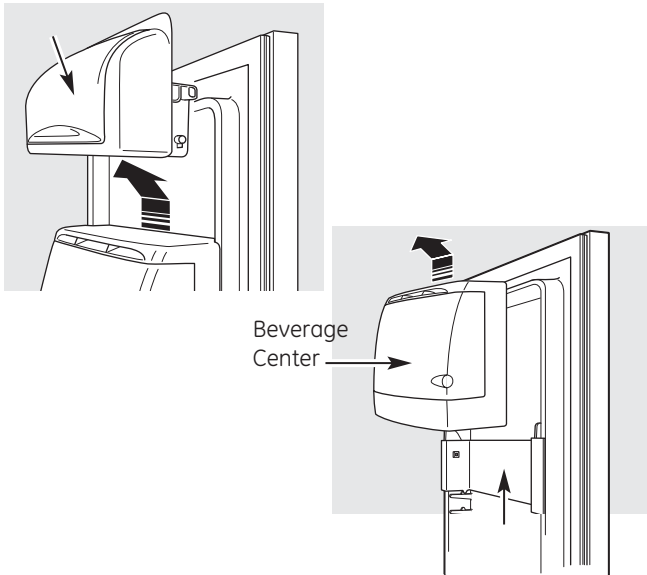

To remove:

Remove dairy bin first. Holding the bottom of the dairy bin first, lift the front straight up, then lift up and out. Holding left and right side of beverage center, lift straight up and out. Leave adapter in place.

To replace:

Engage backside of beverage center in molded supports on adapter. Then push down on the sides of the beverage center. The beverage center will lock into place. Replace dairy bin.

Precise Fill (on some models)

This water dispenser is equipped with a feature called “precise fill.” This feature allows you to choose a precise amount of water (cups, ounces, pints, or liters) that you would like dispensed. Access by pressing: Home > Options > Dispenser Options > Precise Fill > Set Amount. Activate by using the arrow buttons to select the desired amount. Press **MORE UNITS** to select between CUPS, OUNCES, PINTS or LITERS.

Select the precise amount of water you would like dispensed. **If you selected OUNCES**, press the arrowpads on either side of the display to select the number of ounces you would like to have dispensed between 1–128 ounces. **If you selected Liters** you can dispense between 0–4 liters. **If you selected Pints** you can dispense between 0–8 pints.

If you selected CUPS, press the arrow pads on the left of the display to select the whole cups (1–16 cups) and/or the arrow pads on the right side of the display to select fractions of a cup (1/4–3/4 cups).

Press the cup against the cradle and water will begin dispensing. It will automatically stop when the amount set has been dispensed. The display will show there is no water left to dispense, then reset.

Note: Do not leave the dispenser unattended when water is being dispensed.

If you would like to stop dispensing water before the specified amount has been dispensed, just remove the cup from the cradle. The display will show the amount left to dispense.



About the water filter.

Water Filter Cartridge

The water filter cartridge is located in the back upper right corner of the refrigerator compartment.

When to Replace the Filter

A pop-up screen will appear on the LCD screen to remind you to replace the water filter. You can check the status of the water filter manually. Access by pressing: Home > Options > Dispenser Options > Reset Water Filter.

The filter cartridge (part #WR02X12345) should be replaced when the replacement indicator light turns red or if the flow of water to the dispenser or icemaker decreases.

Filter Bypass Plug

You must use the filter bypass plug (part #WR02X12343) when a replacement filter cartridge is not available. The dispenser and the icemaker will not operate without the filter or filter bypass plug.

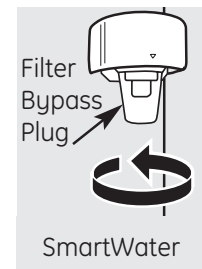
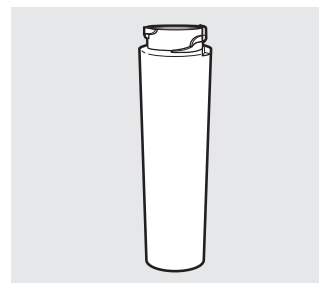

Information and Settings

Use Information and Settings to access Settings, Screen Appearances, and Feature Info. Access by: Home> Options> Information and Settings.

- Press Settings to access Button Beep, Door Alarm, Units Metric/English, and Cooling System Off.
- Press Screen Appearance to access Color Options, Brightness, and Screen Saver.
- Press Feature Info to access information related to Precise fill, CustomCool, QuickFreeze, LCD Screen Colors, Beverage Center, Temperature Set, Quick Ice, and TurboCool..



Cooling System Off

Access by: Home> Options> Information and Settings> Setting> Cooling System Off. Press Enter to turn the cooling system off. To turn the cooling system back on, press the touch screen and press the **ON** button.

Activate By: Pressing **ENTER**.

Note

- Turning the **cooling system OFF** stops cooling in both the freezer and refrigerator compartments, but does not shut off electrical power to the refrigerator.
- When the unit is turned back on, it will be set to the standard settings and will take up to 24 hours to stabilize.



Screen Appearance

Access by: Home> Options> Information and Settings > Screen Appearance.

- Press Color Options to select the color theme of the touch screen.
- Press Brightness to adjust the brightness of the touch screen.
- Press Screen Saver to turn on or off the screen saver display.



Feature Info

Access by: Home> Options> Information and Settings> Feature Info. Features will access information related to:

- Precise Fill
- CustomCool™
- QuickFreeze™
- LCD Screen Colors
- Beverage Center
- Temperature Set
- Quick Ice
- TurboCool™



About the help screen

The Help screen provides General information and guidance to certain features of the refrigerator. The help screen can also provide help regarding the Current screen displayed. To access Help, press the Help pad.



General

Access by: Help> General. Scroll to select help on Freezer, Refrigerator, and Dispenser Options, Information and Settings.



Current

Access by: Help> Current. Press Status Bar, Freezer, Refrigerator, or Options to receive help on selected item.



Demo Mode

The LCD screen has a DEMO MODE that can be accessed. To enter the DEMO Mode press the HOME and HELP pads simultaneously for 3 seconds. Upon entering, the cooling system will turn off.

The VIEW FEATURE selection provides a description and instructions on how to use 8 features of the refrigerator. The 8 features presented are Precise Fill, CustomCool™, QuickFreeze™, LCD Screen Colors, Beverage Center, Temperature Set, Quick Ice, and TurboCool™.

DEMO SCREEN offers instructions on how to select and change compartment temperatures and set dispenser light LEDs on or off. An OPTIONS setting will display freezer options QuickFreeze and Quick Ice, and refrigerator options CustomCool, Beverage Center, and TurboCool.

To exit the DEMO MODE press the HOME and HELP pads simultaneously for 3 seconds. Upon exiting, the cooling system will turn on and the DEMO MODE temperature settings will be used to operate the refrigerator.



Replacing the light bulbs.

Setting the controls to **OFF** does not remove power to the light circuit.

Reveal® appliance bulbs are used on some models. They can be identified by their blue color when they are not illuminated.

Not all features are on all models.

Your light shield will look like one of the following.

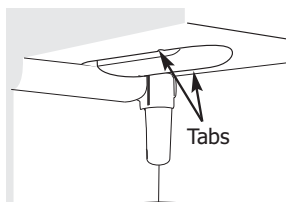

OR

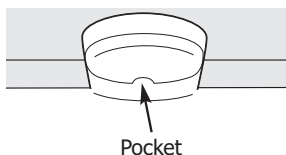

Refrigerator Compartment — Upper Light

Unplug the refrigerator.

The bulbs are located at the top of the compartment, inside the light shield. On some models, a screw at the front of the light shield will have to be removed. On other models, the screw is located in the pocket located at the back of the light shield.

To remove the light shield, on some models, press in on the tabs on the sides of the shield and slide forward and out. On other models, just slide the shield forward and out.

After replacing the bulb with an appliance bulb of the same or lower wattage, replace the light shield and screws (on some models). When replacing the light shield, make sure that the tabs at the back of the shield fit into the slots at the back of the light shield housing.

Plug the refrigerator back in.



Refrigerator Compartment — Lower Light

This light is located above the top drawer.

Unplug the refrigerator.

Remove the convertible meat drawer control knob by pulling straight out.

Lift the light shield up and pull it out.

After replacing the bulb with an appliance bulb of the same or lower wattage, replace the shield and the knob.

Plug the refrigerator back in.

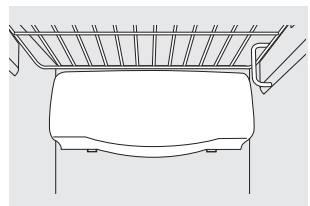

Freezer Compartment

Unplug the refrigerator.

Remove the shelf just above the light shield. On some models, a screw at the top of the light shield will need to be removed.

To remove the light shield, press in on the sides, and lift up and out.

Replace the bulb with an appliance bulb of the same or lower wattage, and

reinstall the light shield. When reinstalling the light shield, make sure the top tabs snap securely into place. Replace the screw (on some models).

Reinstall the shelf and plug the refrigerator back in.

Dispenser LED Light

The LIGHT selection on the LCD screen turns the dispenser LED lights on and off. When the light selection is turned off, the LEDs will fade out. The dispenser LEDs will come on automatically when the dispenser cradle is pressed and will fade out approximately 5 seconds after it is released. The LIGHT selection will not turn off the LEDs during dispensing.

Dispensing Functions

The water, crushed ice, and cubed ice functions are controlled by the main control board. To select a function, press the appropriate pad on the dispenser. The LED will light to identify the selection.

To dispense ice cubes or crushed ice, choose the appropriate pad and depress the dispenser cradle. The solenoid and linkage assembly will open the ice chute duct door to dispense the ice. If cubed ice is selected, a solenoid located behind the ice bucket will lift a rod along the side of the bucket. This rod pulls a flapper away from the cutter blades, allowing cubes to bypass the ice crusher. The dispenser duct door will remain open for approximately 3 seconds after dispensing to allow all ice to clear the chute.

The dispenser light LEDs will come on automatically when the dispenser cradle is pressed and will fade out 5 seconds after it is released.

Dispenser Lock

When the dispenser system is locked, no dispenser command will be accepted. This includes the dispenser cradle and will prevent accidental dispensing that may be caused by children or pets. If the touch screen, pad, or the cradle is depressed with the system locked, it will be acknowledged with three pulses of the LOCK LED accompanied by an audible tone.

To lock or unlock communication between the dispenser and main control board, press the LOCK pad and hold it for 3 seconds. The LOCK LED will flash while the LOCK pad is pressed. When the communication is locked, the LOCK LED will be illuminated.

On some models, the status of other functions selected prior to the initiation of the lock feature will be displayed. If the lock is engaged while a mode is active, the LED will remain on until that mode times out.

If the lock is engaged when the filter timer expires, the LED will come on but cannot be reset until the lock is turned off.

The lock feature will be restored in the event of a power disruption.

Liner Protection Mode

The dual evaporator model has separate liner protection modes for each section. The specific evaporator fan (freezer or fresh food) will start and run on high speed if the door has been open for 3 minutes.

This mode is controlled by 2 timers. Timer #1 monitors door-open time. A 3-minute door-open count begins when the door is opened. If 3 minutes elapse before the door is closed, the liner protection mode will become active. Once the door is closed, timer #1 resets and liner protection mode goes into standby. In standby, normal fan operation resumes and timer #2 begins a 3-minute door-closed count. If 3 minutes elapse without a door opening, liner protection mode will completely deactivate. If a door is opened within the timer #2 door-closed count, the remaining time in the door-closed count will be deducted from the timer #1 door-open count.

About the refrigerator doors.

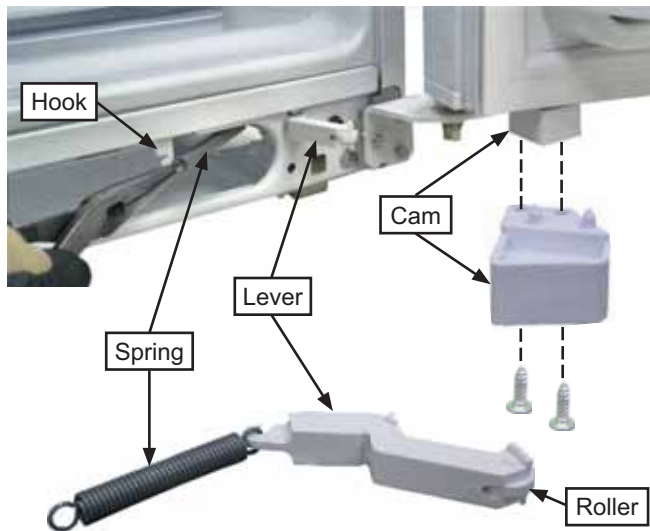

Door Closure Mechanism

The closure mechanism consists of a lever, attached with a spring to a hook in the base channel, which interacts with a cam mounted to the bottom of each door with two T-20 Torx screws. A pair of pliers can be used to remove the spring from the hook. The spring and lever can then be pulled out through the hole in the base channel.

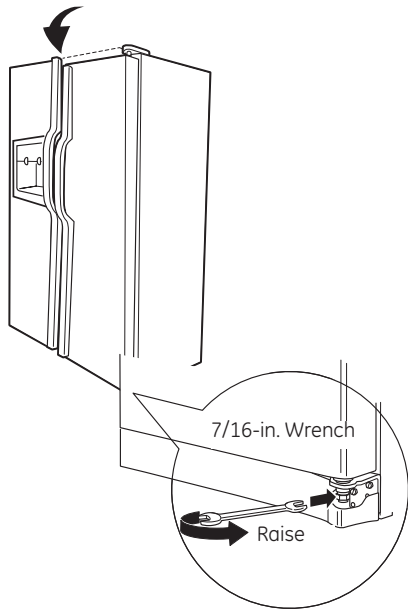

Door Alignment

If doors are uneven, adjust the refrigerator door.

1. Using a $\frac{7}{16}$ -in. wrench, turn the door adjusting screw to the right to raise the door, to the left to lower it. (A nylon plug, imbedded in the threads of the pin, prevents the pin from turning unless a wrench is used.)
2. After one or two turns of the wrench, open and close the refrigerator door and check the alignment at the top of the doors.

Door Handle Removal

Note: Each door handle is held to an upper and lower fastener and locked in position by a recessed tab. Each fastener is located behind the handle and attached to the door panel.

Using a flat blade screwdriver, press the tab on the top underside of the handle toward the front of the handle while sliding the handle up and off of the mounting fasteners.

Door Handle Installation

Install the handle to the handle mounting fasteners by aligning the slots with the handle mounting fasteners. Slide the handle down until it is firmly locked into position.



Components Locator Views

Rear View (Non-Inverter model shown)

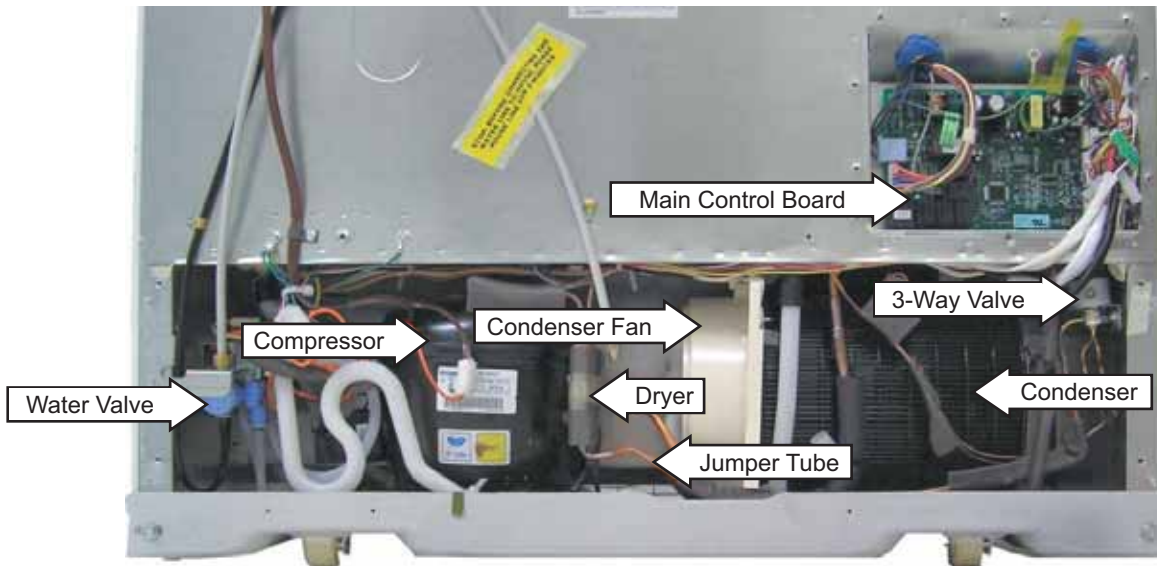

Rear View (Inverter model shown with drain tube and selected wiring removed for clearer view.)

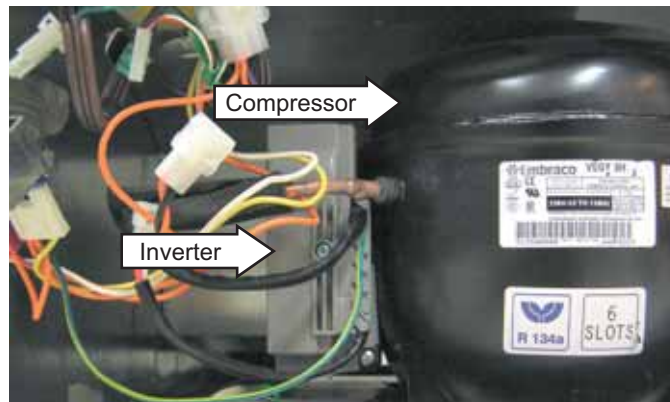

Front View

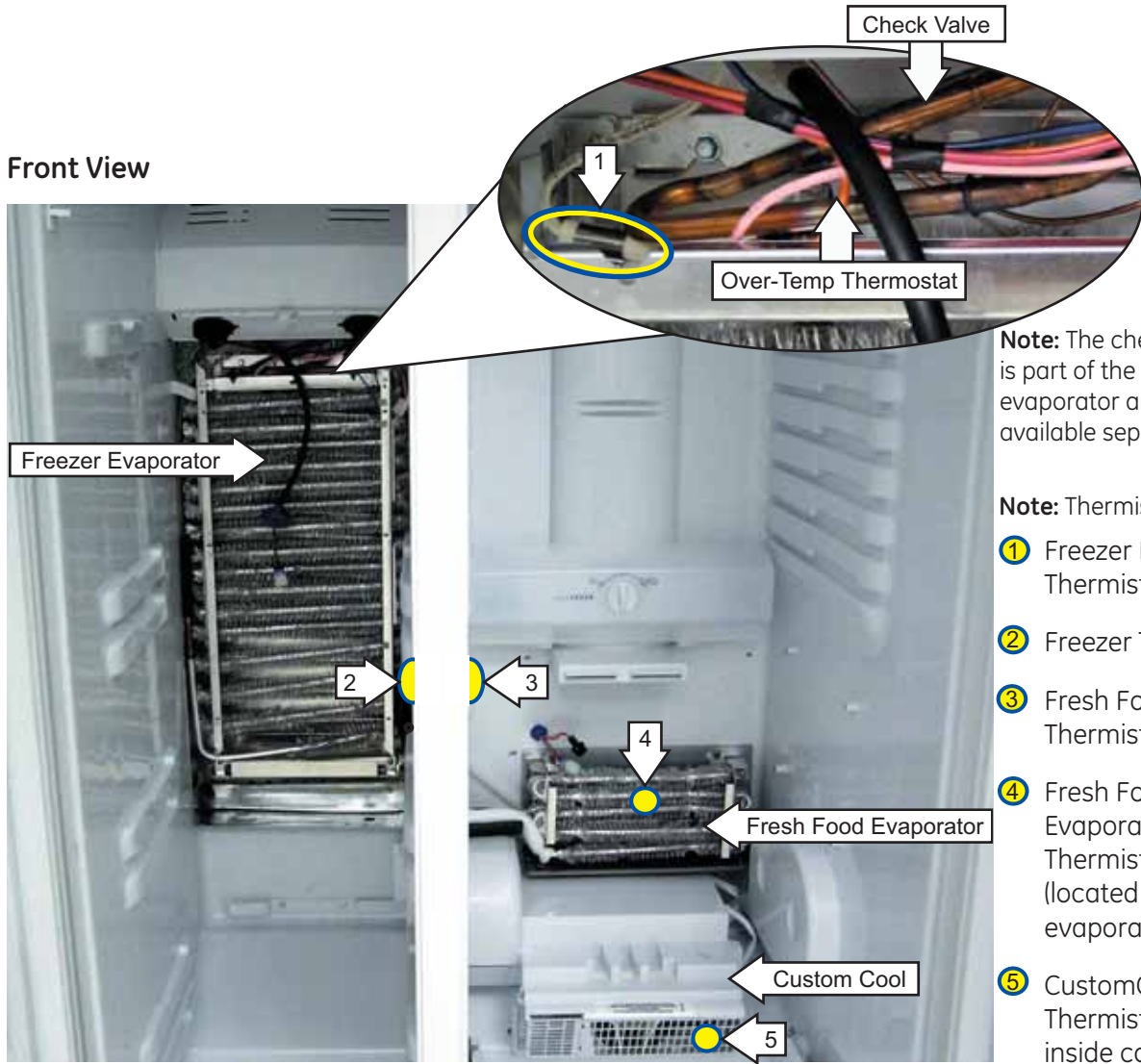

Note: The check valve is part of the freezer evaporator and is not available separately.

Note: Thermistor locations

- ① Freezer Evaporator Thermistor
- ② Freezer Thermistor
- ③ Fresh Food Thermistor
- ④ Fresh Food Evaporator Thermistor (located on back of evaporator)
- ⑤ CustomCool™ Thermistor (located inside compartment)

Refrigeration System

Fresh Food Section Cooling

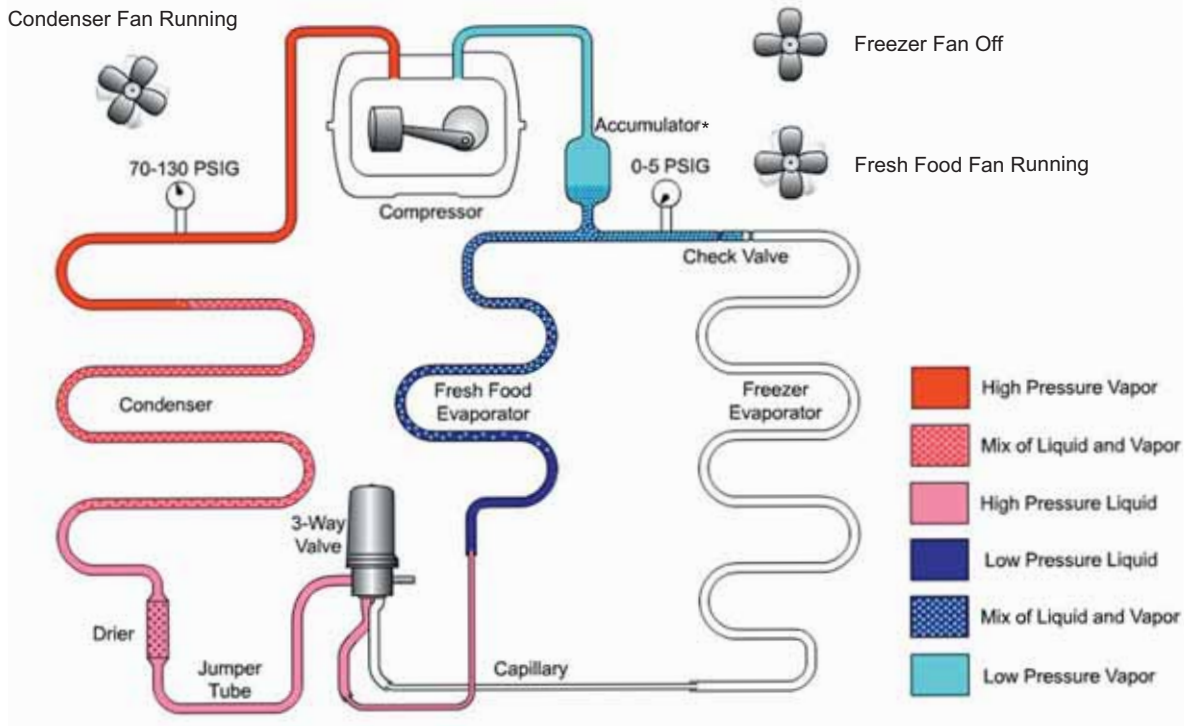

*Note: Variable speed compressors have an accumulator.
Single-speed compressors do not have an accumulator.

Freezer Section Cooling

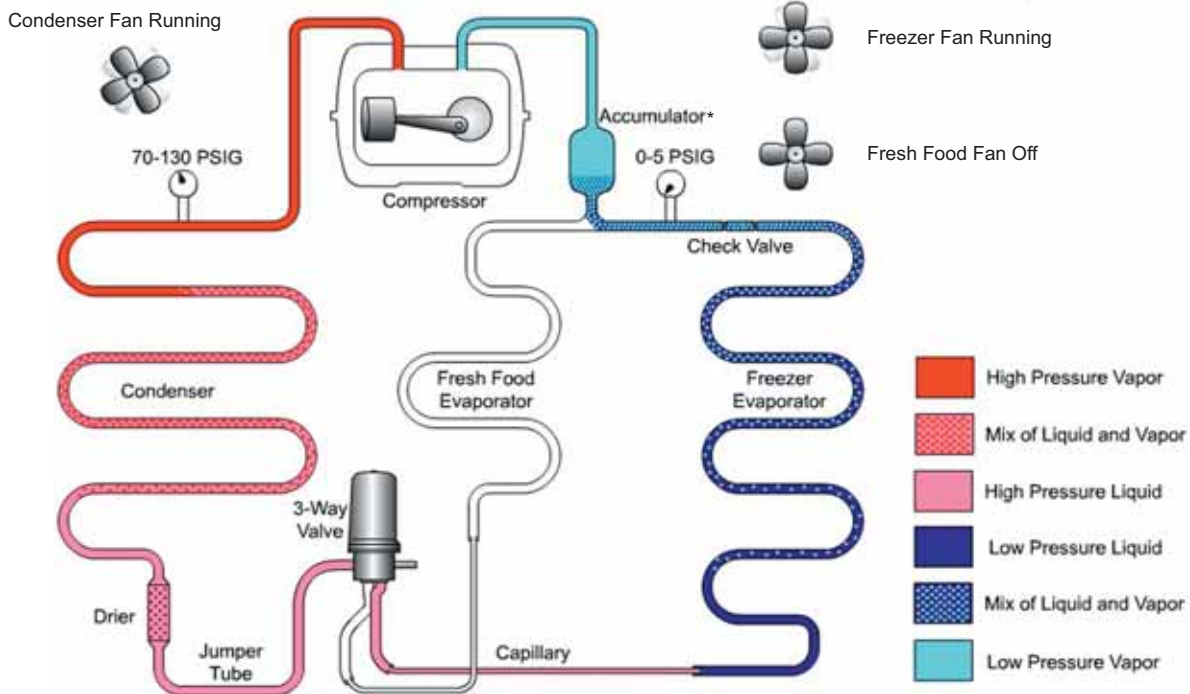

*Note: Variable speed compressors have an accumulator.
Single-speed compressors do not have an accumulator.

(Continued next page)

Fresh Food and Freezer Section Cooling

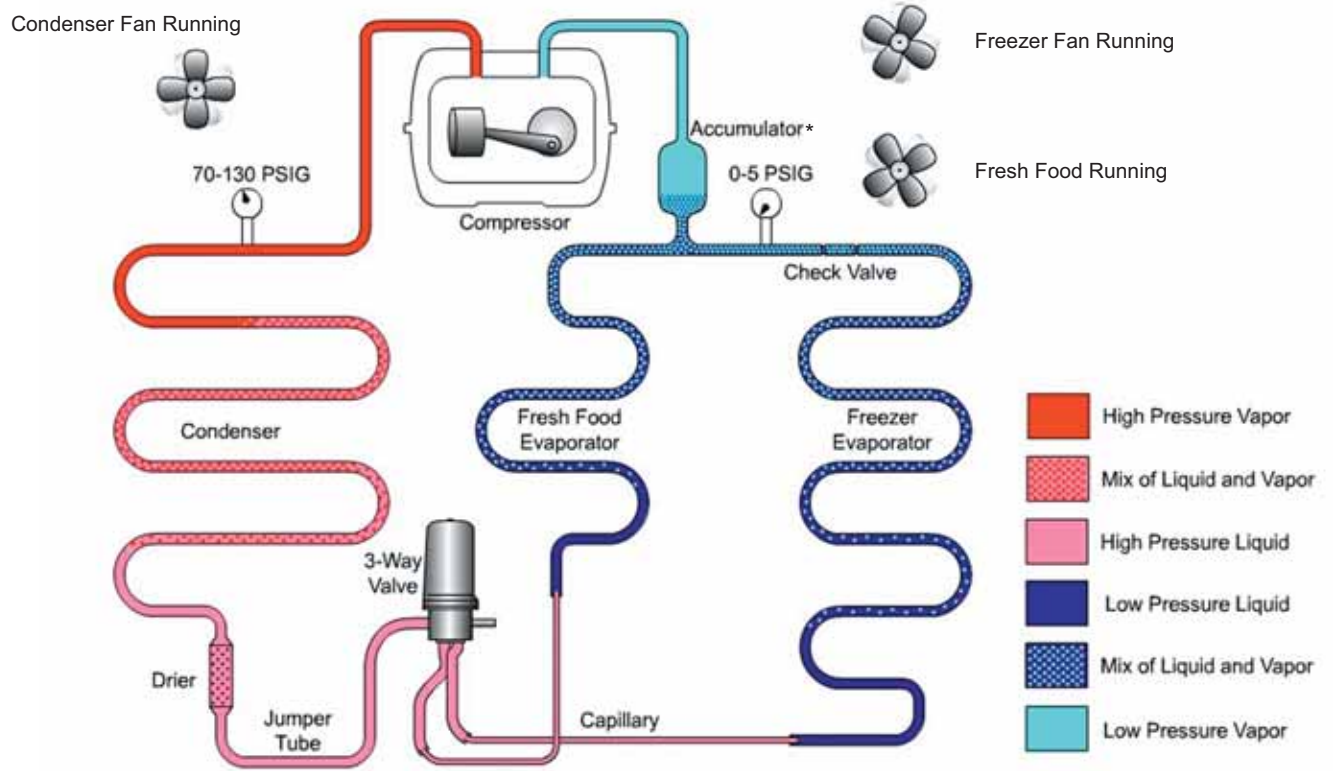

***Note:** Variable speed compressors have an accumulator. Single-speed compressors do not have an accumulator.

Evacuation and Charging Procedure

Refer to Service Guide #31-9118 for complete instruction on replacing the freezer & fresh food evaporators. Refer to Service Guide #31-9067 for complete instructions on using the LOKRING method of installing an evaporator.

WARNING:

- Be careful when using a torch inside the plastic cabinet. Use approved safety equipment and protect the liner from damage with the heat shield kit (part #WX5X8926) which includes the heat shield and thermal paste. The thermal paste is available separately (part #WX5X8927).
 - Before cutting or using a torch on refrigerant tubes, recover the refrigerant from the system using approved recovery equipment.
 - Never charge new refrigerant through the purge valve. This valve is always located on the high-pressure side of the system.
 - Never apply heat from any source to a container of refrigerant. Such action will cause excessive pressure in the container.
 - Always wear goggles when working with refrigerants and nitrogen holding charge in some replacement parts. Contact with these gases may cause injury.
1. Attach the hose from the R-134a charging cylinder to the process tube port on the compressor.
 2. Evacuate the system to a minimum 20-in. vacuum using the refrigerator compressor and recovery pump, which is attached to the new drier assembly.
 3. Turn off the recovery pump. Close the ball valve on the hose connected to the high-pressure side port connection. Add 3 ounces of R-134a refrigerant to the system. Let the refrigerator operate and circulate the refrigerant for 5 minutes.
 4. Open the ball valve. Recover the purge/sweep charge using the recovery pump and the refrigerator compressor until a 20-in. vacuum is attained. Close the ball valve and remove the recovery hose.
 5. Charge the system with the exact amount of R-134a refrigerant specified.
 6. Disconnect the power cord to the refrigerator. This allows the pressure to equalize. After 3 to 5 minutes, the low-pressure side will be positive and then, the hose-to-charging port can be disconnected.
 7. Using an electronic leak detector, check all brazed joints and both schrader ports. Reinstall caps to schrader ports.

Components

Freezer Evaporator

The following components must be removed in the appropriate order to access the freezer evaporator:

1. Unplug the refrigerator.
2. Remove the ice bucket, shelves, and drawers.
3. Using a small flat-blade screwdriver, expand the 2 clips and disconnect the icemaker wire harness from the auger motor assembly.



Note: The icemaker is held to the left side freezer wall with a Phillips-head screw, spacer, and 2 posts.

4. Remove the single Phillips-head screw from the icemaker.



5. Rotate the icemaker to the right, then pull the left side towards the front to disengage it from the 2 posts.



6. Remove the four ¼-in. hex-head screws from the front of the auger motor assembly.



7. Lift the auger motor assembly up, pull it forward, and disconnect the wire harness.



8. Remove the four ¼-in. hex-head screws that attach the QuickFreeze™ fan housing (if equipped), to the 2 mounting brackets.



(Continued next page)

9. Lift the fan housing up, pull it forward, and disconnect the wire harness.
10. Remove the two ¼-in. hex-head screws that attach each mounting bracket.

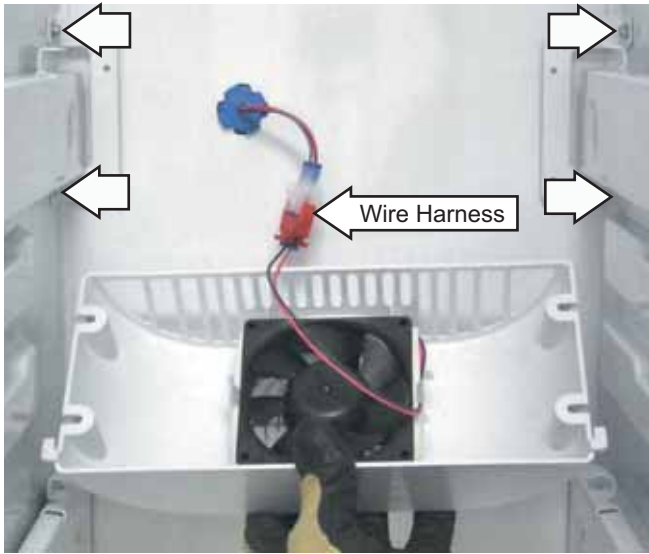

11. Slide the air tunnel upward to remove.



Note: Failure to replace the air tunnel will affect temperature performance.

12. Remove the three T-20 torx screws that attach each drawer track to the left wall of the freezer.
13. Remove the light bulb cover and light bulbs.

14. Unclip the light bulb sockets from their mounting holes and disconnect the sockets.



Note: The evaporator cover is held in place by four ¼-in. hex-head screws and 2 top tabs. The tabs are inserted into recessed slots in the bottom of the evaporator fan plenum.

15. Remove the 4 hex-head screws that hold the freezer evaporator cover in place.
16. Lift the cover up to clear the front lip of the drain trough, then lower the cover to release it from the 2 recessed slots.
17. Pull the left side of the cover out and rotate the harness grommet clockwise to release it from the cover.
18. Carefully remove the cover from the freezer.



(Continued next page)

19. Press inward on the 2 tabs and release the auger motor assembly wire harness receptacle from the evaporator fan plenum.

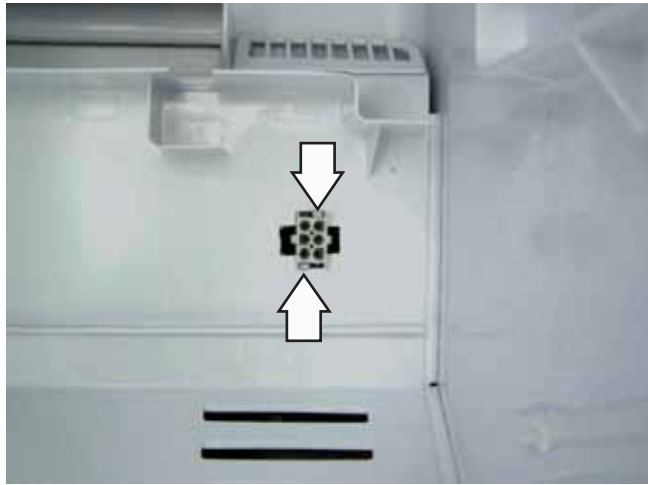

20. Remove the 4 hex-head screws that hold the evaporator fan plenum in place (Fig. 1 and Fig. 2).

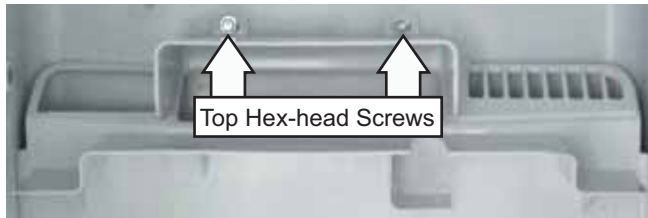

Fig. 1

Note: The bottom hex-head screws are hidden under the bottom of the evaporator fan plenum.



Fig. 2

21. Unclip the evaporator thermistor and ground wires from the evaporator.
22. Remove the two ¼-in. hex-head screws from the fan bracket.

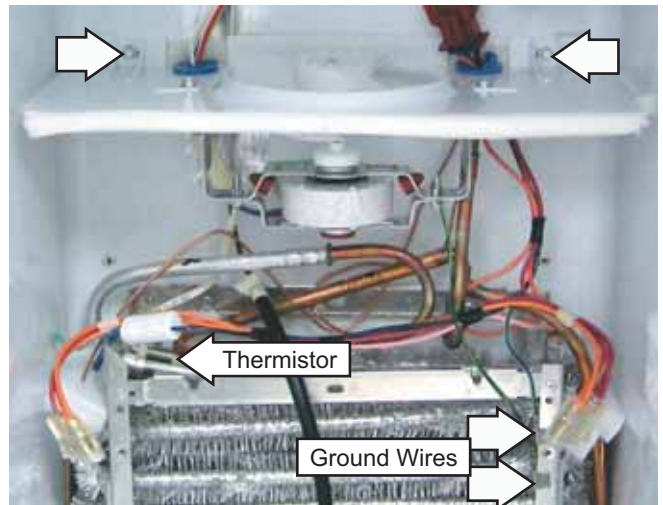

23. Peel back the tape then slide out the wiring grommets from the fan bracket.

24. Remove the fan bracket.

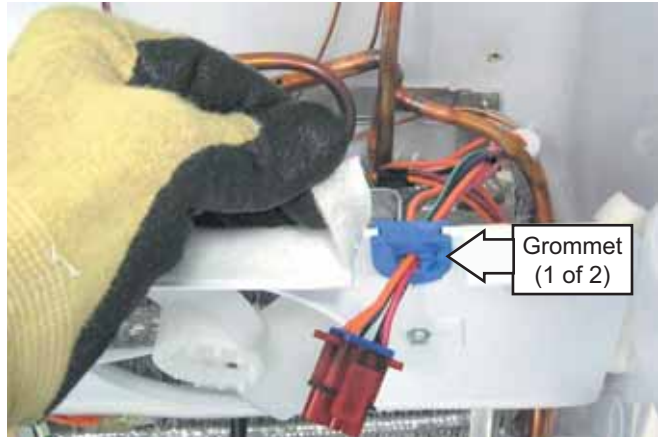

Fresh Food Evaporator

The following components must be removed in the appropriate order to access the fresh food evaporator:

1. Remove the CustomCool™ drawer, and necessary drawers and covers above the CustomCool drawer, to expose the evaporator cover.

Note: The water line coil cover is slotted. To remove it, slide the water line coil cover toward the door opening.

2. Remove the water line coil cover and lay the water line assembly down on top of the CustomCool housing for better access to the fresh food evaporator fan cover.
3. Pull out and remove the top insulation cover and the bottom tubing cover and styrofoam block inside.

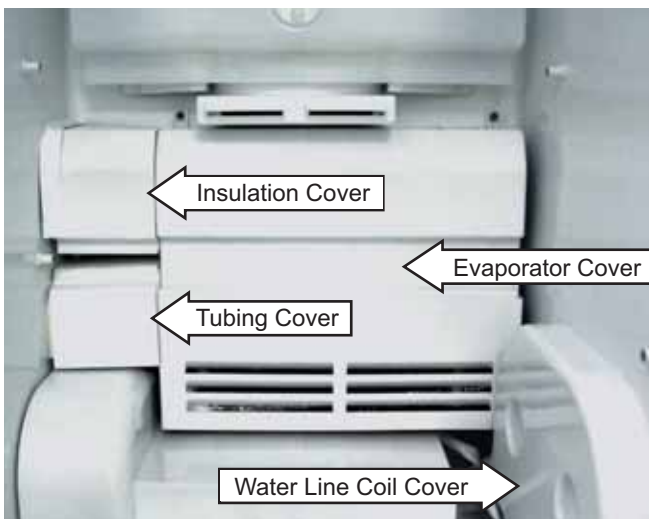

4. Remove the 3 Philips-head screws that hold the fresh food evaporator fan cover in place.

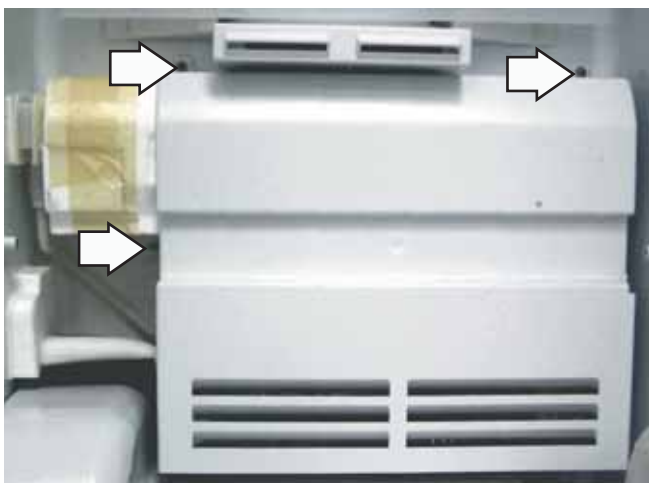

5. Carefully pull the cover forward, then disconnect the fresh food evaporator fan and beverage center blower.

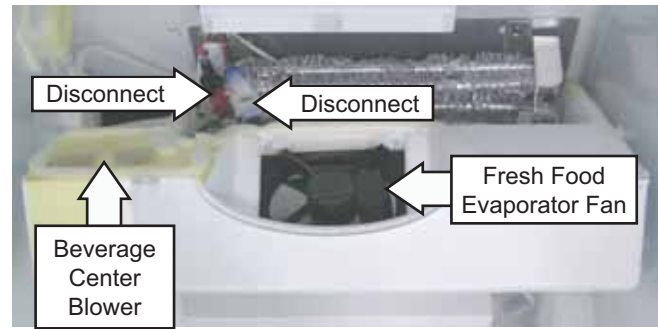

6. Loosen the 2 Phillips-head screws that hold the fresh food evaporator in place.

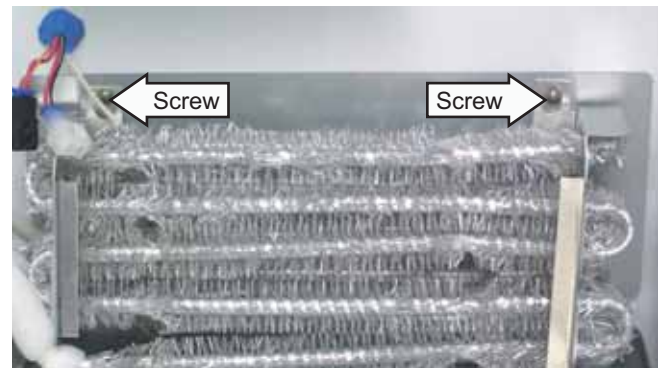

7. Carefully lift and pull the fresh food evaporator forward. Cut the tie strap that holds the thermistor thermal block in place.

8. Remove the evaporator thermistor and block from the evaporator.

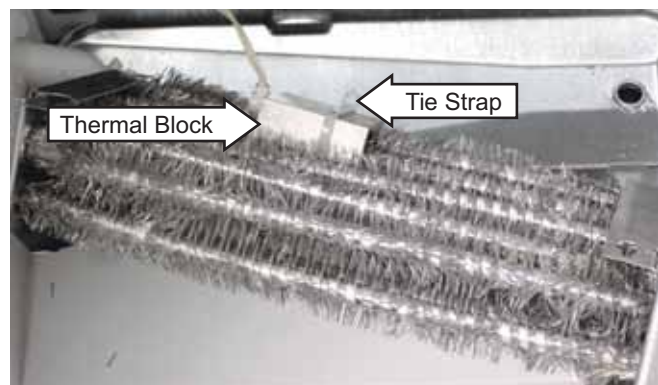

Check Valve

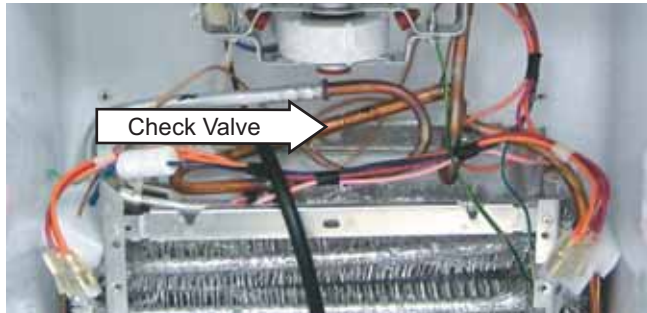

- A nylon piston inside the check valve floats back and forth, depending upon refrigerant flow.
- The check valve prevents refrigerant from flowing back into the freezer evaporator.
- When the main control rotates the 3-way valve for fresh food only cooling, the check valve will prevent refrigerant from flowing in the freezer evaporator (refrigerant will naturally flow to the coldest area).
- The check valve is only available with a new freezer evaporator.

Caution: Do not attempt to replace only the check valve. The nylon piston in the check valve is extremely heat sensitive.

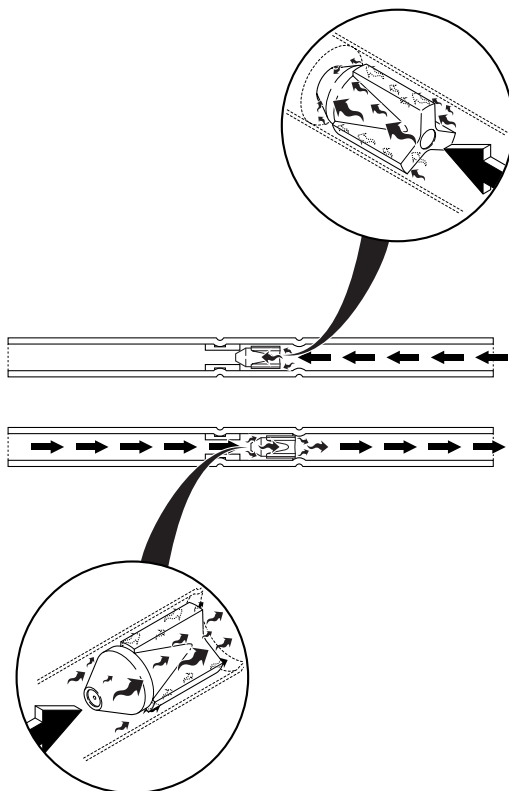

Fresh Food Evaporator Fan

A variable speed 12-VDC motor is mounted in front of the fresh food evaporator. The fan, the blower, and evaporator cover are replaced as a complete assembly.



When activated, the fresh food evaporator fan recirculates the air in the fresh food compartment, providing cooling independent of the freezer evaporator fan.

The main control board gathers information from the fresh food thermistors to determine when, and at what speed, fan operation should occur.

A constant 13.6 VDC is provided to the fan from the main control board (J2 pin 8 to J2 pin 3).

Speed is regulated by pulse width modulation on the common side of the fan. When operating, the common side of the circuit is pulsed open and closed. This pulsing produces effective voltage being received at the motor, which is equivalent to a reduction in voltage. Fan speed is selected and maintained by the main control board regulating the length and frequency of the 13.6-VDC pulse.

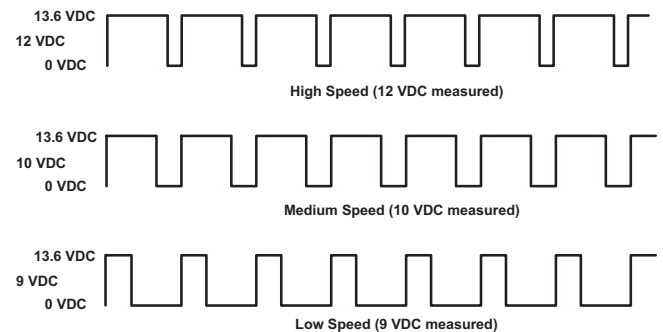

Beverage Center Blower Motor

A 12-VDC blower motor is mounted inside the fresh food evaporator fan housing. The blower motor, evaporator fan, and evaporator cover are replaced as a complete assembly.



When activated (See **Control Features**), the beverage center blower circulates air from the fresh food evaporator into the beverage center bin. The air enters the beverage center through a channel molded inside the center wall. A drain tube allows accumulated moisture from the bottom of the air channel to be directed to the fresh food evaporator drain trough.

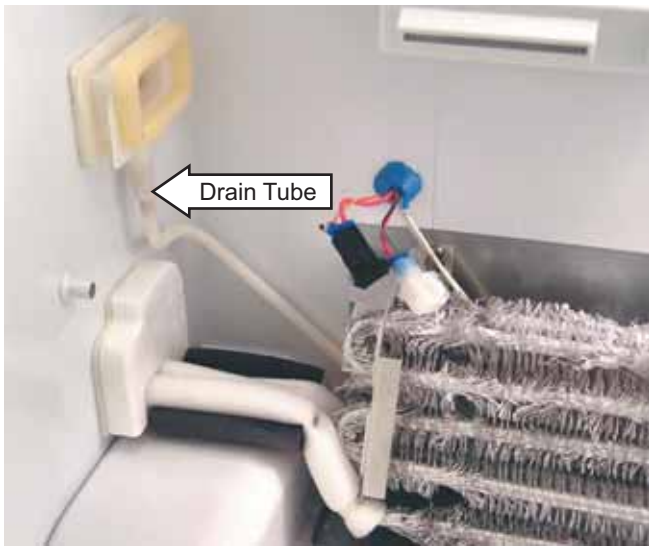

A constant 13.6 VDC is provided to the fan from the main control board (J2 pin 8 to J2 pin 3) when the fresh food door is closed.

The blower will cool the beverage center bin up to 4°F (-15.5°C) less than the set point of the fresh food. The main control board works with the fresh food thermistor and the fresh food evaporator thermistor to create an algorithm. This algorithm turns the beverage center blower motor on and off to keep the bin cool. The main control board will also monitor fresh food temperatures and will not allow items to freeze in the bin.

For testing, the beverage center blower motor can be run for short periods using a 9-volt battery.

Note: Unless turned off at the control, the beverage center feature will remain active for 6 months. Press the **Beverage Center** pad to restart.

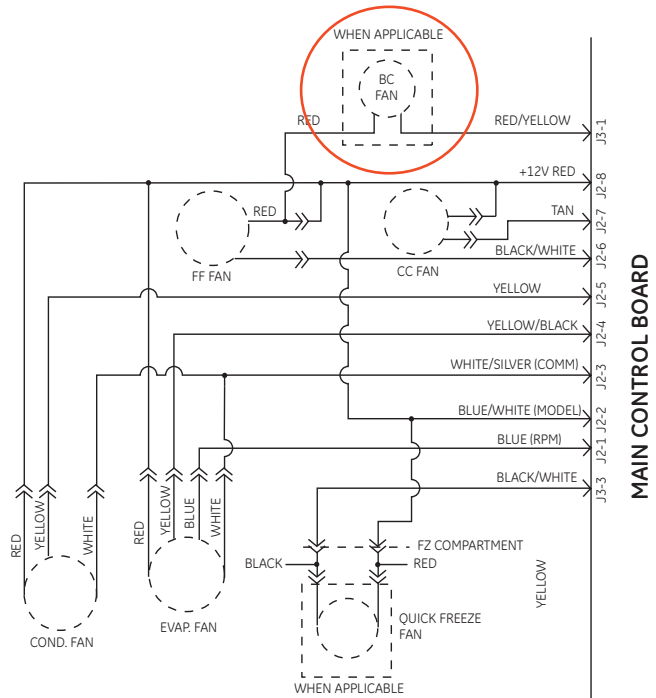

Freezer Evaporator Fan

The position of the fan blade in relation to the shroud is important.

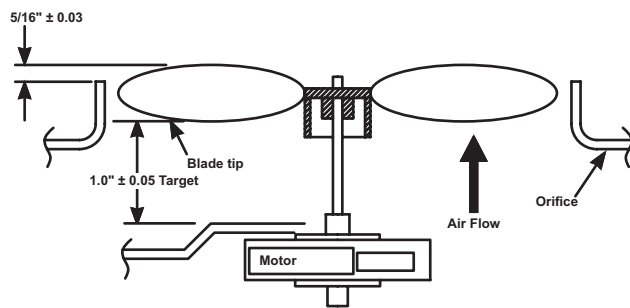

The evaporator fan is the same fan used on previous models; however, a significant difference is that the main control board neither requires nor receives input from the fan feedback/rpm (blue) wire. The fan utilizes a permanent magnet, 4-pole, DC motor that operates at 3 different speeds: high, medium, and low.

The speed of the fan is controlled by the voltage output from the main control board (J2 pin 8 to J2 pin 3). Voltage output from the main control board to the fan is 13.6 VDC; however, to regulate the speed of the fan, the main control board uses pulse width modulation.

When operating, voltage is sent in pulses (much like a duty cycle) as opposed to an uninterrupted flow. This pulsing of 13.6 VDC produces effective voltage being received at the motor, which is equivalent to a reduction in voltage.

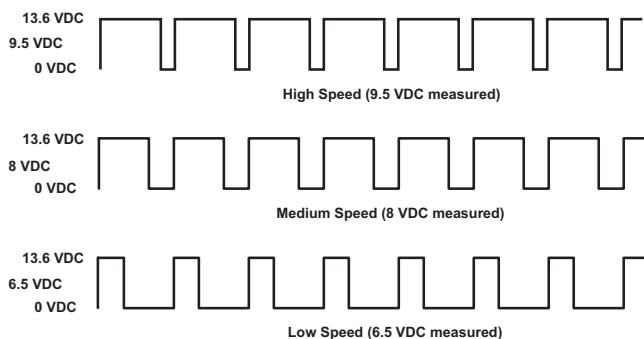

Fan speed is selected and maintained by the main control board regulating the length and frequency of the 13.6-VDC pulse. Temperature can cause some fan speed variation. Fan speed can vary +/- 5%, depending on the temperature, with higher temperatures causing slightly higher speeds.

The evaporator fan has a 4-wire connection:

White Wire - DC Common (J2 pin 3)

The white wire is the DC common wire used for testing. During repairs, DC polarity must be observed. Reversing the DC polarity causes a shorted motor and/or board.

Red Wire - Supply (J2 pin 8)

Each motor uses an internal electronic controller to operate the motor. Supply voltage from the main control board remains at a constant 13.6 VDC.

Blue Wire - Feedback/RPM (J2 pin 1)

On previous Arctica models, the blue wire reported rpm (speed) information to the main control board for speed control purposes. On this model, the board does not require or read any feedback information from the fan motor.

Yellow Wire - Signal (J2 pin 4)

The yellow wire is the input wire from the main control board. The main control board provides 6.5-VDC effective voltage for low speed, 8-VDC effective voltage for medium speed, and 9.5-VDC effective voltage for high speed. The fan operates in low speed only when the fresh food thermistor is satisfied.

Note: When testing these motors:

- You cannot test with an ohmmeter.
- DC common is not AC common.
- Verify 2 voltage potentials:
 - a. Red to white - power for internal controller
 - b. Yellow to white - power for fan
- Observe circuit polarity.
- Motors can be run for short periods using a 9-volt battery. Connect the white wire to the negative (-) battery terminal only. Connect the red and yellow wires to the positive (+) battery terminal.

QuickFreeze™ Fan Motor

A 12-VDC motor is mounted in front of the freezer evaporator cover. The fan motor and fan housing are replaced as a complete assembly.

When activated (See **Control Features**), the QuickFreeze™ fan circulates freezer air directly onto food placed on the aluminum tray. Food can be frozen up to 2 times faster, reducing moisture loss when food is thawed. A constant 13.6 VDC is provided to the fan from the main control board.

For testing, the motor can be run for short periods using a 9-volt battery. Observe circuit polarity. Connect the red wire to the positive (+) battery terminal and the remaining wire to the negative (-) battery terminal.

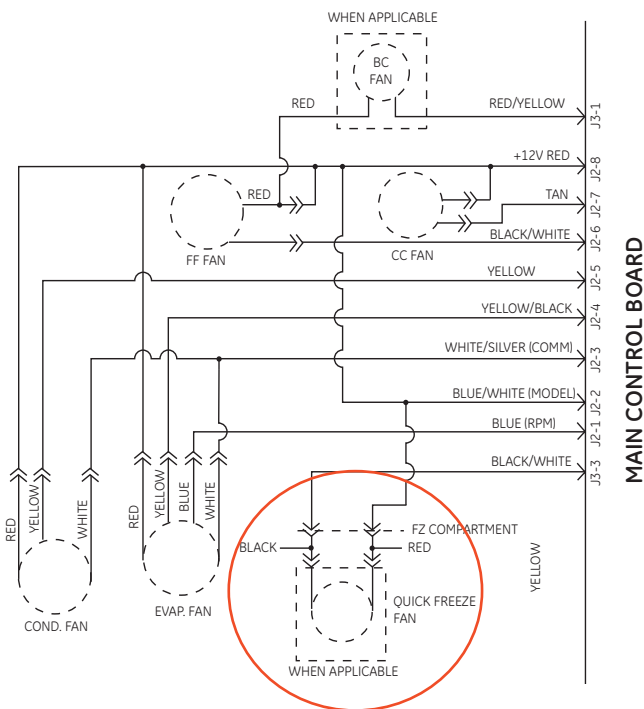

Condenser Fan

The fan is mounted in the machine compartment with the no-clean condenser. The fan and fan shroud are mounted on one end of the condenser, and the other end of the condenser is blocked.

When the fan is operating, air is pulled from the center of the condenser, drawing air in through the coils. The air is then exhausted over the compressor and out the right side of the refrigerator.

Inlet air is available through the left front and left rear of the machine compartment. A rubber divider strip underneath the refrigerator divides the inlet and outlet sides of the machine compartment.

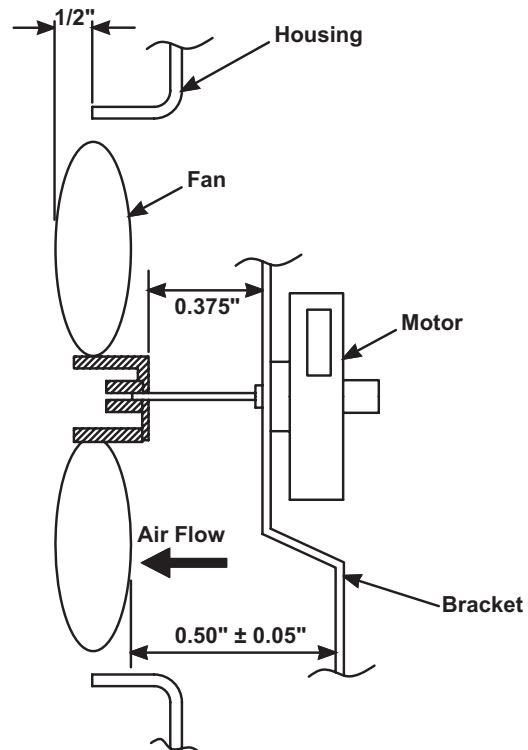
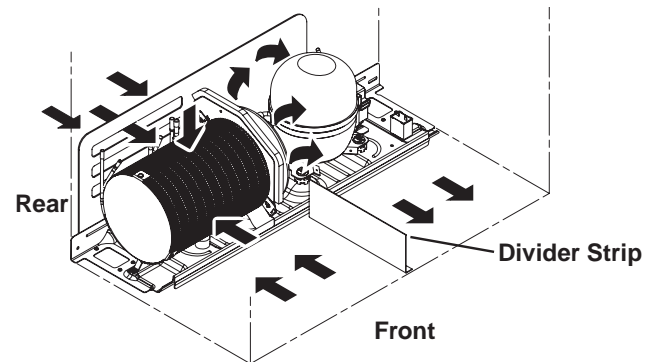

The rear access cover must be tightly fitted to prevent air from being exhausted directly out of the rear of the machine compartment, bypassing the compressor.

The condenser fan is mounted with screws to a fan shroud and mounting bracket that is attached to the condenser. To access the condenser fan motor, disconnect power from the refrigerator and remove the machine compartment cover.

Depending on the model, use one of these two methods to remove the condenser fan motor from the refrigerator.

Method #1:

1. Disconnect the condenser fan plug, then remove the ¼-in. hex-head screw from the upper corner (closest to you).
2. Pull the shroud assembly slightly to disengage from the mounting tab.
3. Tilt the shroud assembly towards the compressor and gently pull the assembly out .

Method #2:

1. Pull the condenser fan blade off the motor shaft.
2. Remove the two ¼-in. hex-head screws that hold the mounting bracket together.
3. Remove the front mounting bracket and note the position of the grommet.
4. Disconnect the condenser fan plug, remove the wire harness from the fan shroud clips, then remove the fan motor.



On inverter compressor models, condenser fan speed coincides with compressor speed (low, medium, high) to minimize pressure variations in the sealed system except when the freezer temperature is 20°F above the set point. If this condition exists (such as during initial startup), the condenser fan operates at super high speed while the compressor operates at medium speed.

Note: Single-speed compressor models use a single-speed condenser fan.

The speed of the fan is controlled by the voltage output from the main control board (J2 pin 8 to J2 pin 3). Voltage output from the control board to the fan is 13.6 VDC; however, to regulate the speed of the fan, the main control board uses pulse width modulation.

When operating, voltage is sent in pulses (much like a duty cycle) as opposed to an uninterrupted flow. This pulsing of 13.6 VDC produces effective voltage being received at the motor, which is equivalent to a reduction in voltage.

Fan speed is selected and maintained by the main control board regulating the length and frequency of the 13.6 VDC pulse.

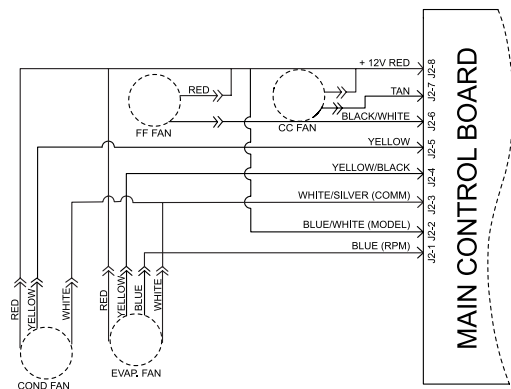

Temperature can cause some fan speed variation. Fan speed can vary +/- 5%, depending on the temperature, with higher temperatures causing slightly higher speeds.

Condenser fan speed is controlled by pulse width modulation, the same method used to control fan speeds for the evaporators.

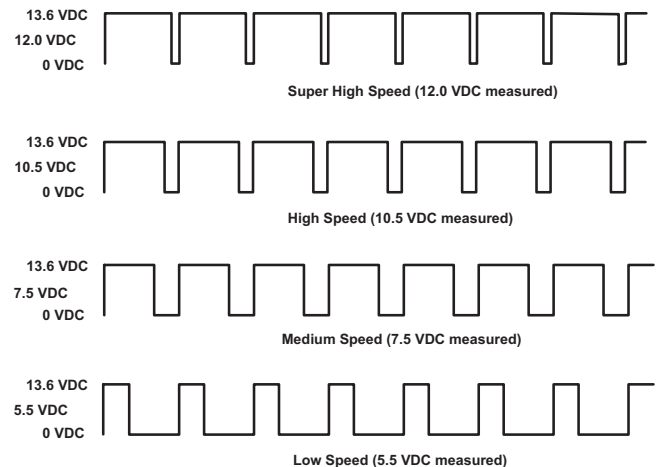

Thermistors

Thermistor Resistance		
Temperature (°F)	Temperature (°C)	Resistance in Kilo-Ohms
-40	-40	166.8 kΩ
-31	-35	120.5 kΩ
-22	-30	88 kΩ
-13	-25	65 kΩ
-4	-20	48.4 kΩ
5	-15	36.4 kΩ
14	-10	27.6 kΩ
23	-5	21 kΩ
32	0	16.3 kΩ
41	5	12.7 kΩ
50	10	10 kΩ
59	15	7.8 kΩ
68	20	6.2 kΩ
77	25	5 kΩ
86	30	4 kΩ
95	35	3.2 kΩ
104	40	2.6 kΩ
113	45	2.2 kΩ
122	50	1.8 kΩ
131	55	1.5 kΩ
140	60	1.2 kΩ

Note: To accurately test a thermistor, place the thermistor in a glass of ice water (approximately 33°F) for several minutes and check for approximately 16K Ω.

Fresh Food and Freezer Thermistors

The fresh food and freezer thermistors (part # WR55X10025) are located in the mullion dividing the fresh food and freezer compartments.

Note: The fresh food and freezer thermistors are removed in the same manner.

To remove the thermistor cover, insert a flat-blade screwdriver under the front of the cover and gently lift at the bottom edge until it releases from the compartment wall.

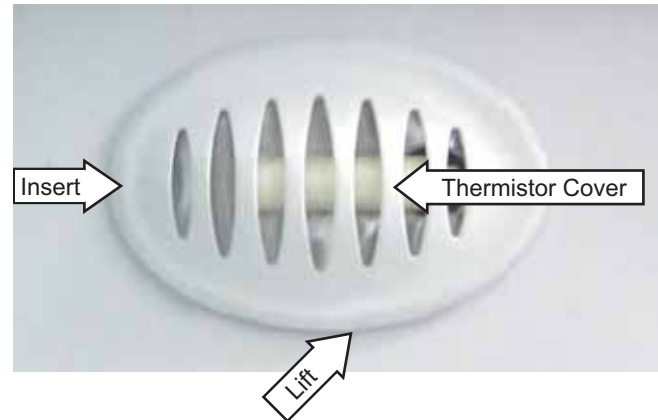

Freezer Evaporator Thermistor

The freezer evaporator thermistor (part # WR55X10025) is clipped to the top coil of the freezer evaporator. (See **Freezer Evaporator** for accessing instructions.)

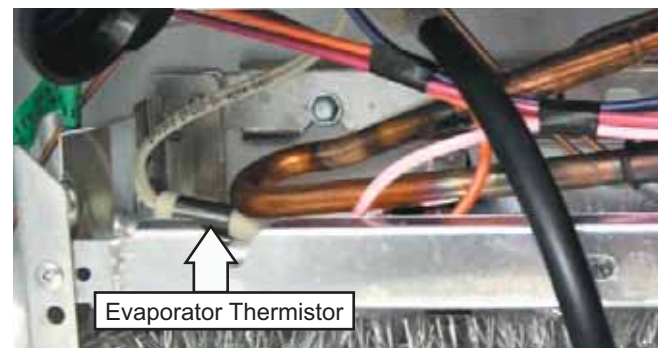

(Continued next page)

Fresh Food Evaporator Thermistor

The fresh food evaporator thermistor (part # WR55X10025) is located in an aluminum thermal block on the back of the evaporator. It is attached to the fresh food evaporator by a wire tie. (See **Fresh Food Evaporator** for accessing instructions.)

If the fresh food evaporator thermistor is either open or shorted, the main control board defaults to a fixed defrost cycle of 1 hour at high-speed fan.

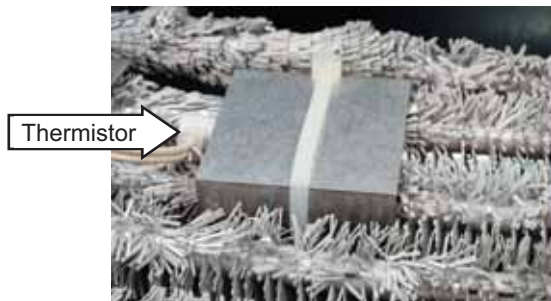
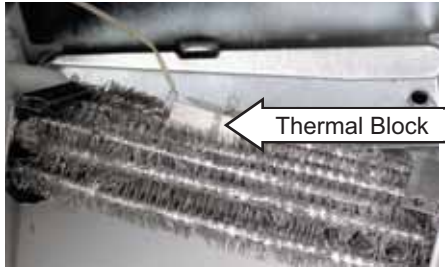

Barbs on the molded housing hold the thermistor in the thermal block.

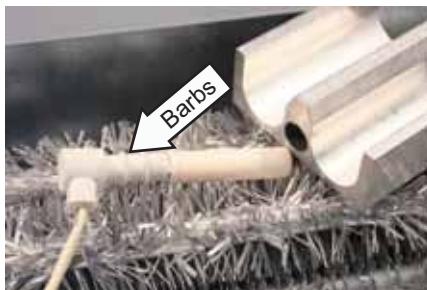

Replacement

Should a thermistor require replacement, use plastic bell connectors (part # WR01X10466). Fill the connector with RTV102 silicone, then splice a new thermistor into the harness as shown in the illustration.

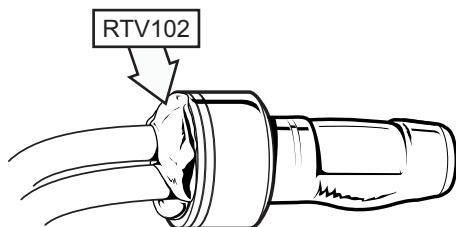

Insert the new thermistor into the thermal block. Add RTV102 silicone to hold the thermistor in place. Make certain to wire tie the thermal block back to the evaporator.

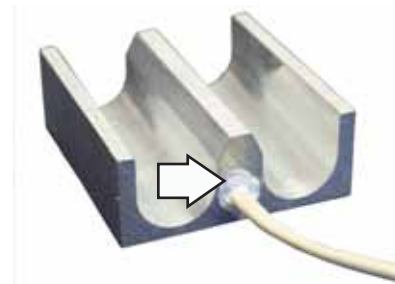

Defrost Cycles

Fresh Food Evaporator Defrost Cycle

The refrigerator utilizes a forced air cycle defrost method (no electric heater) to remove frost from the fresh food evaporator. Fresh food air that is above freezing temperature circulates thru the coil and melts any accumulated frost. Note that during fresh food defrost, the compressor may still be running, cooling only the freezer section.

Fresh Food Normal Defrost

The fresh food section cools until the fresh food thermistor is satisfied.



If both freezer and fresh food thermistors are satisfied, the compressor cycles off. If the freezer still requires cooling, the main control board rotates the 3-way valve to stop refrigerant flow to the fresh food evaporator. Even though refrigerant flow has stopped in the fresh food evaporator, the fresh food fan continues to run at low speed.

The system is designed to run the fan until the fresh food evaporator thermistor reaches 35°F.

Once this temperature is reached, the fan continues to run for an additional 5 minutes. Under normal conditions, the defrost time takes approximately 30 minutes. The maximum time the fan runs in low speed is 60 minutes. If the evaporator thermistor has not reached 35°F after 60 minutes, the control switches to extended defrost #1.

Fresh Food Extended Defrost #1

Occasionally there may be excessive frost on the evaporator coil. This can be attributed to numerous door openings, extremely high humidity, poor door gasket seal, etc. If the normal defrost fan time exceeds 60 minutes, the fan switches to high speed. The control continues to monitor the fresh food evaporator thermistor for 35°F. When 35°F is reached, the fan runs for an additional 5 minutes at high speed. The fan can run up to an additional 30 minutes at high speed, trying to reach 35°F. After 90 total minutes of fan time (60 at low speed and 30 at high speed), if the fresh food evaporator is still below 35°F, the control will switch to extended defrost #2.

Fresh Food Extended Defrost #2

If the fresh food fan has been operating for 90 minutes, the main control searches for a fresh food thermistor temperature above 52°F. If the fresh food thermistor is above 52°F, the main control board assumes there is a problem reading the fresh food evaporator thermistor, ends the defrost cycle, and returns to normal cooling.

If the fresh food thermistor is less than 52°F, the main control board assumes there is refrigerant leaking through the 3-way valve, keeping the fresh food evaporator cold during the defrost process while the freezer evaporator is cooling. The main control board shuts off the compressor and runs the fresh food fan at high speed until 2 conditions are met: the evaporator thermistor reaches 35°F and the fresh food thermistor is 2½°F above the set point. As in the other cycles, the fan continues to run for an additional 5 minutes after the 35°F evaporator temperature is reached.

Fresh Food Forced Defrost

If the main control board senses the fresh food section has been cooling for 45 minutes, it immediately stops the refrigerant flow through the fresh food evaporator. The main control board changes the position of the 3-way valve if cooling is still required in the freezer, or turns the compressor off if the freezer is satisfied. The fresh food fan operates on high speed until the evaporator reaches 35°F, plus an additional 5 minutes after the evaporator reaches 35°F.

To prevent the refrigerator from going into forced defrost when first installed or after a power failure, the control will disregard the 45 minute time limit if the freezer temperature is above 20°F.

Note: If the fresh food evaporator thermistor is either open or shorted and the 35°F cutoff cannot be determined, the main control board defaults to a fixed defrost cycle of 1 hour at high-speed fan.

Freezer Defrost Cycle

The freezer evaporator utilizes a defrost heater to remove frost from the coil. The control board determines the length of time the heater is energized. It does this by monitoring the freezer evaporator thermistor. Once the temperature of the thermistor reaches 75°F, the control cycles the defrost heater off. A bimetal safety thermostat (L140-30) provides a backup in the event the evaporator thermistor fails. The safety thermostat prevents the temperature from exceeding 140°F.

Note:

- During the freezer defrost cycle, the compressor does not operate, even if the fresh food section is above the set point.
- When initiating a freezer defrost cycle, there is a 6-second delay from the time the main board shuts off the power to the compressor and when the defrost heater is energized.

Inverter

The inverter is accessed from the back of the refrigerator and is located on the left side of the compressor behind the water valve. The water valve must be removed to access the inverter.

To remove the Inverter:

1. Disconnect power to the refrigerator and remove the back access panel.
2. Remove the ¼-in. hex-head screw that holds the water valve to the cabinet, then carefully pull the water valve out from the cabinet.
3. Disconnect the 2 wire harnesses to the inverter.
4. Remove the ¼-in. hex-head screw and the inverter ground wire from the cabinet.

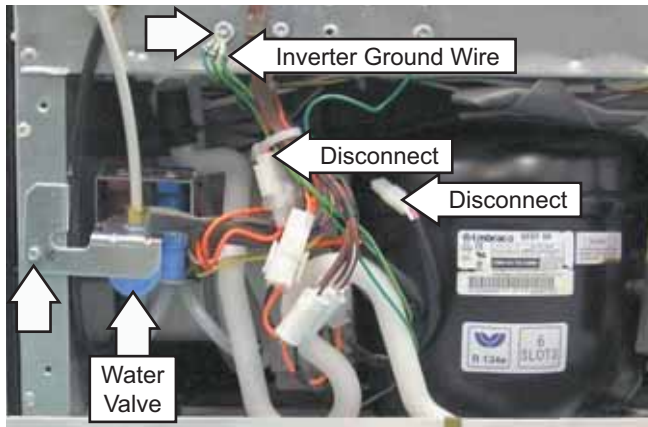

Note:

- The inverter is attached to the compressor by a lip above the compressor terminals, a tab (located at the bottom rear corner), and a Phillips-head screw.
 - Inverter shown with drain tube and selected wiring removed for clearer view.
5. Remove the Phillips-head screw from the inverter.



6. Lift and rotate the inverter counterclockwise.
7. Disconnect the compressor harness from the compressor terminals.

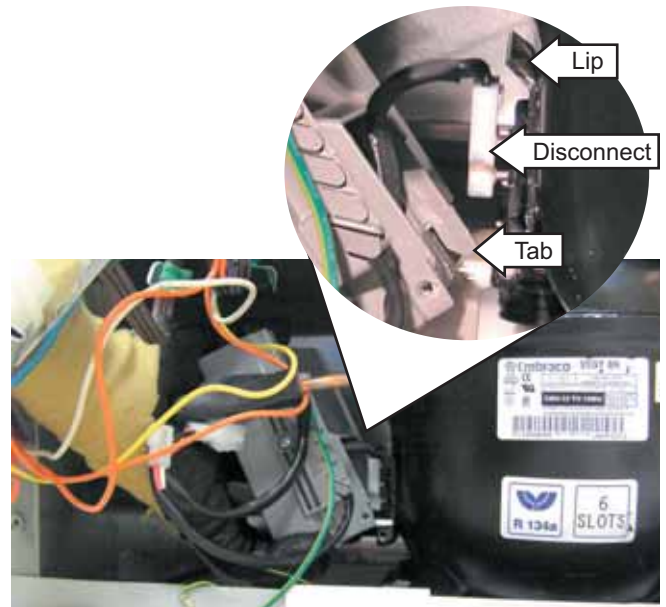

WARNING: When the refrigerator is plugged in, 120 VAC is always present at the inverter.

Note: Certain voltmeters will not be able to read voltage output from the inverter. If no voltage or erratic voltage is measured, it does not necessarily indicate a faulty inverter.

The inverter receives 120-VAC line-in from the power supply (black and orange wires). The inverter converts this single-phase, 60 Hz, 120 VAC into 3-phase, 230 VAC, with frequency variations between 57 Hz and 104 Hz. This voltage is delivered to the compressor through 3 lead wires. Each wire will carry identical voltage and frequency.

Note: The compressor leads must be connected to measure voltage output. If the compressor wires are not connected, or if an open occurs in one of the 3 lead wires or in the compressor, the inverter will stop voltage output.

When checking inverter voltage output, connect the test-meter leads to any 2 of the 3 compressor lead wires at the inverter plug (plug should be connected). The same reading should be measured between any 2 of the 3 wires.

(Continued next page)

The inverter controls compressor speed by frequency variation and by pulse width modulation. Changing frequency and pulse width modulation will cause an effective voltage between 80 and 230 VAC to be received at the compressor.

- Low speed (1710 rpm) - 57 Hz
- Medium speed (2100 rpm) - 70 Hz
- High speed (3120 rpm) - 104 Hz

The inverter receives commands from the main control board (red and white wires). The main control board will send a pulse width modulation run signal from the J15 connector of between 4-6 VDC effective voltage to the inverter (all wires must be connected). The inverter will select compressor speed (voltage output) based on this signal.

The main control board will only send a run signal to the inverter when the compressor should be on.

Note: When measuring signal voltage (from the main control board) at the inverter, a reading of 4-6 VDC will be measured with all wires connected. If the inverter wiring is disconnected, the board output will measure between 10-12 VDC.

The inverter will monitor compressor operation and if the compressor fails to start or excessive current draw (4 amps maximum) is detected, the inverter will briefly stop voltage output. The inverter will then make 12 consecutive compressor start attempts (once every 12 seconds). After 12 attempts, if the compressor has not started, an 8-minute count will initiate. After the 8-minute count, the inverter will attempt to start the compressor again. If the compressor starts, normal operation will resume. If the compressor fails to start, this process will be repeated. Removing power to the unit will reset the inverter count. When power is restored, the inverter will attempt to start the compressor within 8 seconds.

The inverter has a built-in circuit protection to guard against damage from a failed or shorted compressor. However, if a failed compressor is diagnosed, order a new compressor and inverter. If the compressor fails to start after replacement, replace the inverter.

Inverter Compressor

Caution: Do not attempt to direct-start the compressor. The compressor operates on a 3-phase power supply. **Applying 120 VAC to the compressor will permanently damage the unit.** It is not possible to start the compressor without an inverter.

The compressor is a reciprocating, variable speed, 4-pole type. It operates on 3-phase, 80 to 230 VAC within a range of 57 to 104 Hz.

Note: Certain voltmeters will not be able to read voltage output or frequency from the inverter.

Compressor wattages at various speeds are:

- LOW - 65 watts
- MED - 100 watts
- HIGH - 150 watts

The compressor is controlled by the inverter, which receives its signal from the main control board. Varying the frequency to the inverter changes the compressor speed.

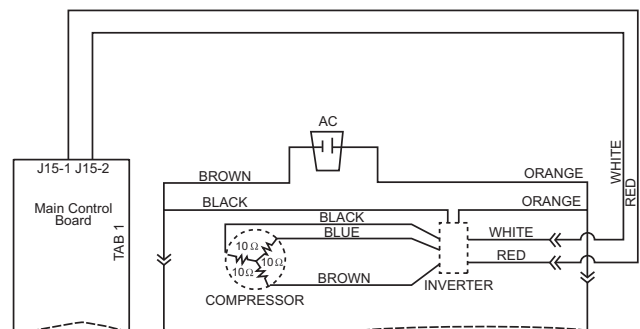

Compressor speed is based on the temperature set point in conjunction with the specific cabinet temperature. Speeds are selected according to the following cabinet temperatures, with freezer temperature being the primary:

- 7°F to 19.5°F above freezer set point = high speed.
- 4.5°F to 6.5°F above freezer set point = medium speed.
- 1°F to 4°F above freezer set point = low speed.
- 1°F to 2.5°F above refrigerator set point = low speed.

(Continued next page)

- 3°F to 5°F above refrigerator set point - medium speed.
- 5.5°F to 7°F above refrigerator set point - high speed.

Note: The compressor will run at medium speed if the freezer temperature is 20°F or more above the setpoint.

The use of 3-phase power eliminates the need for the relay, capacitor, and individual start and run windings; therefore, the start, run, and common pins found on conventional compressors are not applicable on this 3-phase model. Compressor pin functions are identical and compressor lead wire configuration is of no importance. A resistance of 9Ω to 11Ω should be read between any 2 of the 3 pins. Should an open occur in the compressor winding or should one of the compressor lead wires become open or disconnected, the inverter will stop voltage output to the compressor.

High compressor torque enables the compressor to start against high pressure in the sealed system. When power has been disconnected from an operating unit, the high torque will enable the compressor to start immediately upon power restoration.

Compressor operation is extremely smooth and cool. The compressor exterior may be slightly higher than room temperature while operating; therefore, it may be difficult to detect a running unit.

To verify that the compressor is running:

Disconnect power from the unit and place a hand on the compressor. Reconnect power and feel for a vibration when the compressor tries to start. It may take up to 8 seconds before the compressor attempts to start.

Note:

- When ordering a replacement compressor, order both the compressor and inverter. Replace the compressor first. If, after compressor installation, the compressor fails to start, replace the inverter.
- When servicing the compressor, it is important to dress the wiring to keep low voltage DC wiring and 120 VAC wiring separate.

Single-Speed Compressor

The compressor is a reciprocating type. Refer to the mini-manual for the BTU/hour rating and the compressor capacity test specification.

To verify that the compressor is running:

WARNING: During normal operation, the temperature of the single-speed compressor may be hot. Use caution to avoid injury and wear Kevlar® gloves or equivalent protection.

Disconnect power from the unit. Wait 3 to 5 minutes for pressure to equalize. Place a hand on the chassis, near the compressor. Reconnect power and feel for a vibration when the compressor tries to start.

Note: The single-speed compressor will start right away if pressure is equal.

A ¼-in. O.D. copper process tube is provided for access to the low-pressure side of the refrigeration system.

Refer to the compressor replacement instructions included with the replacement compressor. Evacuate and recharge the system using currently accepted procedures. (See **Evacuation and Charging Procedure.**)

3-Way Valve

The 3-way valve is located beneath the main control board in the machine compartment and is accessed from the back of the refrigerator. It is composed of a magnetic coil and a valve body. Two ¼-in. hex-head screws mount the valve to the cabinet.

- Make certain that rubber gaskets are installed on mounting bracket to reduce vibration.

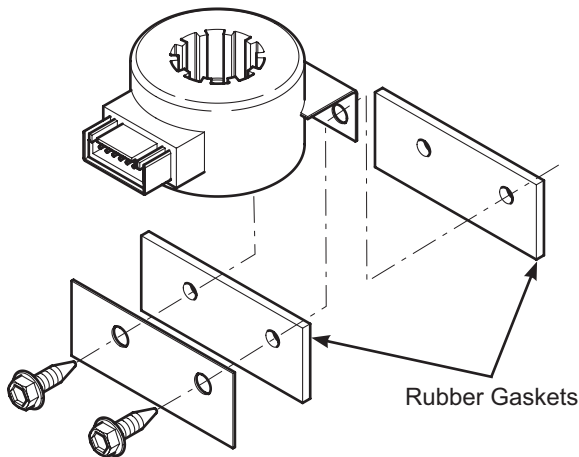

- Three copper tubes connect to the 3-way valve.
- One jumper tube connects from the drier to the inlet on the valve.
- A freezer capillary and a fresh food capillary connect to the other two tubes on the valve.

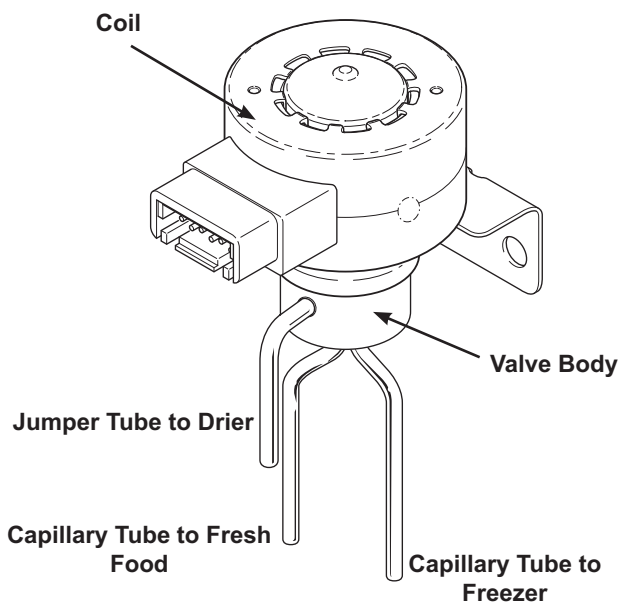

3-Way Valve Coil

The 3-way valve coil receives 12-VDC pulses from the main board to change the position of the valve. The pulses come too quickly to measure with a volt meter.

The 3-way valve coil has a resistance value of approximately 46 ohms that can be measured between the coil pins.

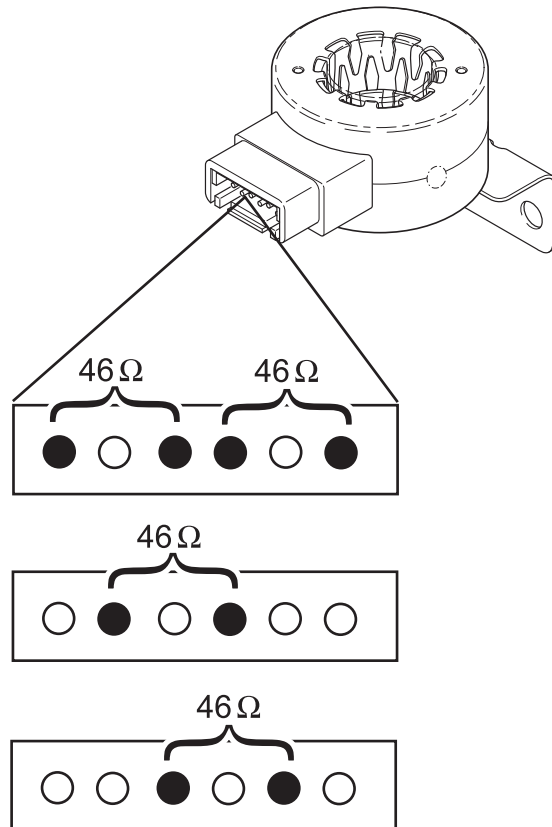

(Continued next page)

3-Way Valve Body

- The valve body contains a cam, rotor, and magnet.
- The rotor and cam are grooved to rotate with the magnet.
- The entire valve body has refrigerant flowing through it when the compressor is operating.
- Use care not to damage the top of the valve body when installing the coil on the valve.
- A locating pin is used to correctly align the valve body in the valve coil.
- Failure to fully seat the valve in the coil or to align it correctly with the pin can cause the system to stop cooling.

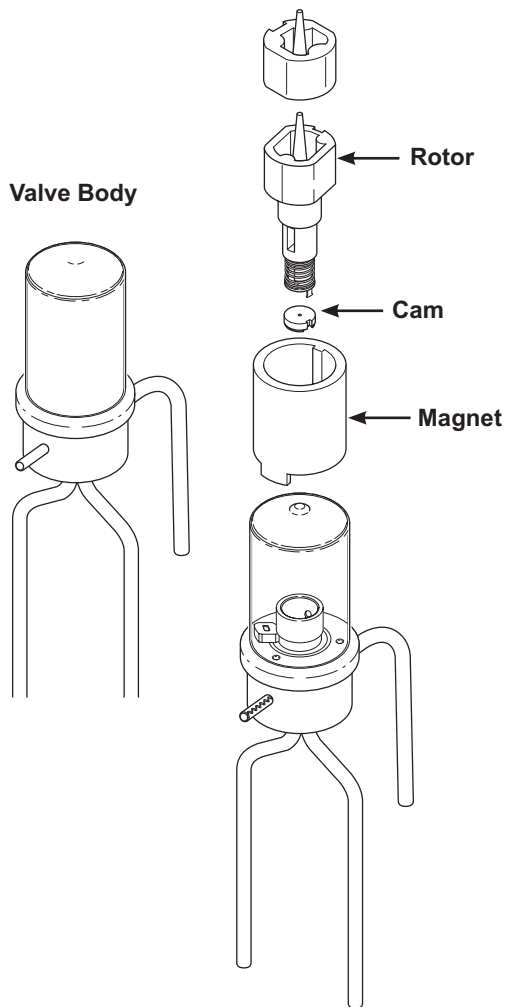

Note: The 3-way valve comes only as a complete assembly. Exploded view is for reference only.

Valve Rotation

- The pulses of the valve coil cause the magnet to rotate inside the valve body.
- As the magnet rotates, it moves the cam at the bottom of the valve.

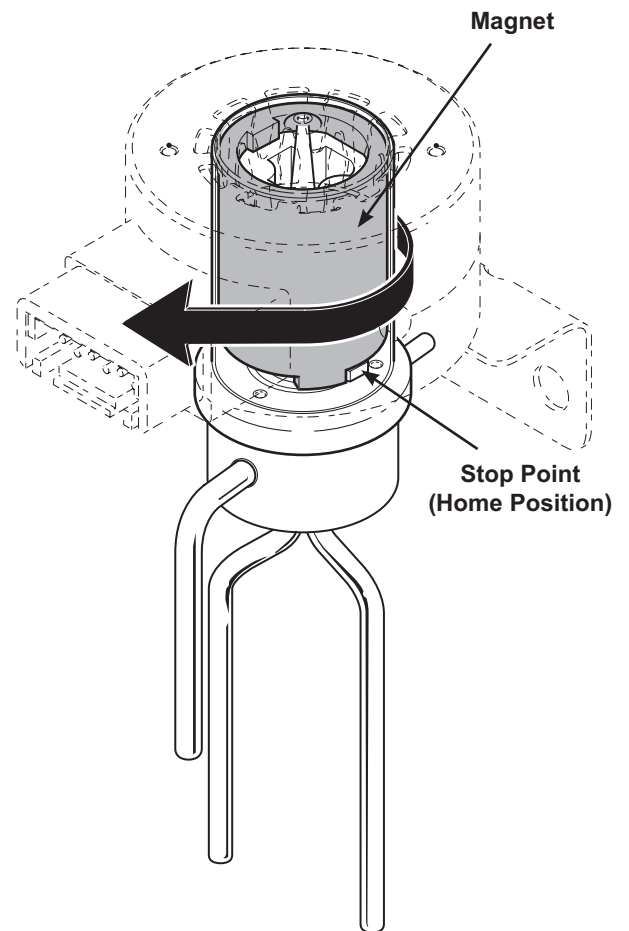

The cam opens or covers the ports to the capillary tubes.

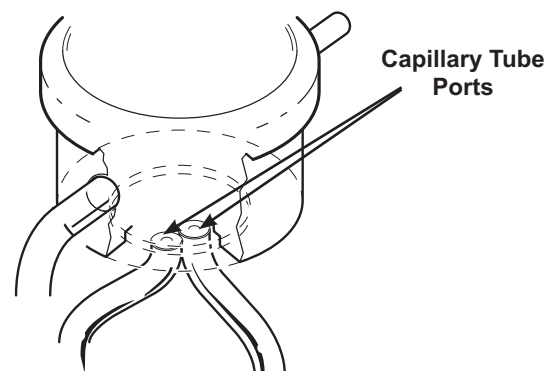

Testing the 3-Way Valve

The valve returns to “home” at the end of every freezer defrost cycle and whenever the refrigerator is reconnected to power.

To test the valve, disconnect the refrigerator from power for at least 10 seconds, place a finger on top of the valve, and reconnect power.

The main control overdrives the valve to the “home” position.

You should be able to feel the valve vibrate as the coil moves the magnet to the home position .

If movement is present, the main board and valve coil are operating correctly.

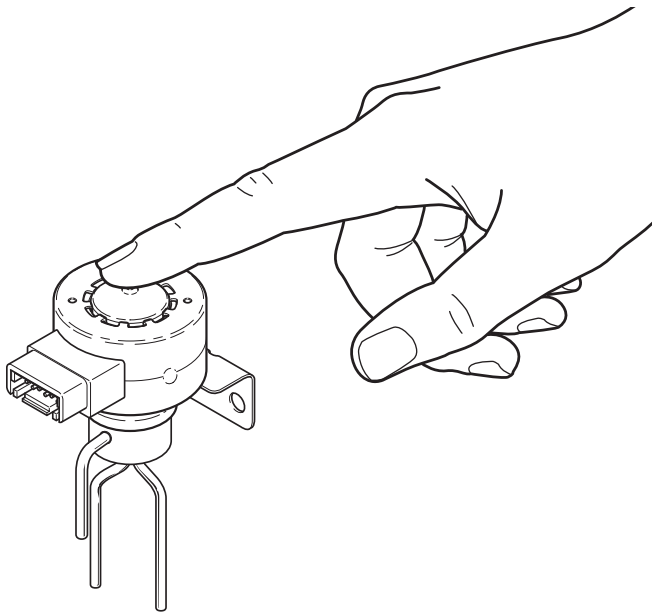

Replacing the 3-Way Valve

Parts Needed:

- 3-Way Valve (part # WR57X10053)
- Thermal Paste (part # WX5X8927)
- Drier Assembly (part # WR86X93)
- Process Valve (part # WJ56X61)

When replacing a 3-way valve, note the black mark on the freezer outlet tube. Make certain to mark the freezer capillary by placing a piece of tape on the capillary, 6-8 inches from the valve. This will aid in installing the capillaries in the correct outlet tubes.

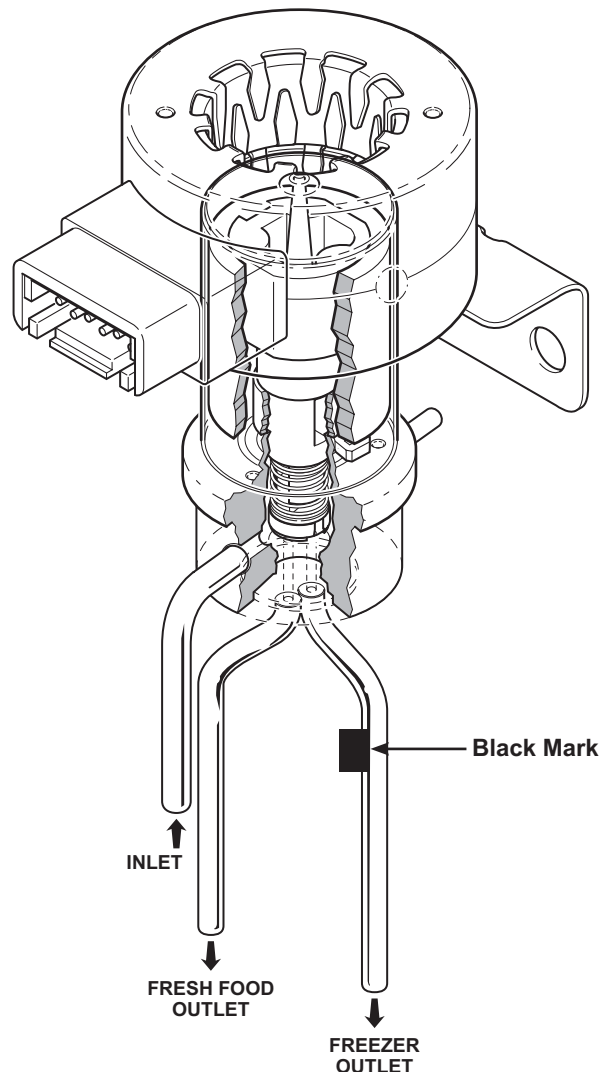

1. Unplug the refrigerator.
2. Remove the rear access cover and evacuate the sealed system. (See **Evacuation and Charging Procedure.**)
3. Remove the valve body from the valve coil by carefully pressing down on top of the valve body.

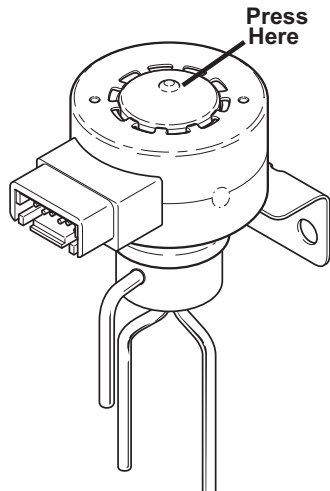

5. Connect the new jumper tube to the inlet tube of the new 3-way valve.
6. Prepare the taped capillary tube, and insert it into the 3-way valve freezer outlet port (identified with black mark or tape).
7. Prepare the remaining capillary tube and insert it into the 3-way valve fresh food outlet port.

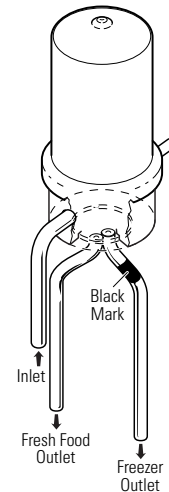

4. Tape the freezer capillary tube 6 inches below the brazing joint. Score and break the two capillary tubes below the brazing joints.

8. Apply a liberal amount of thermal paste to the base of the three tubes on the new valve. Apply a wet cloth to the top of the valve to help keep the valve cool.

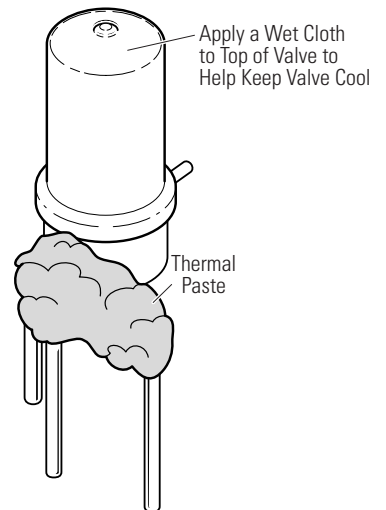
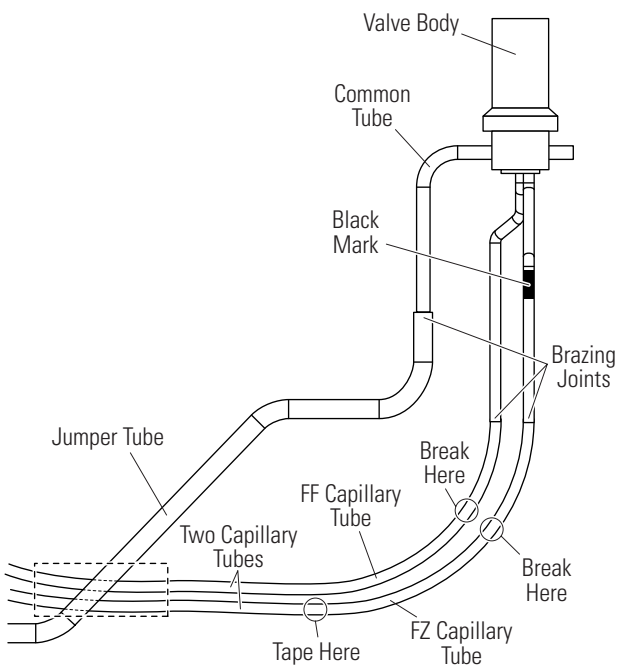

9. Angle the torch so the flame is not directed towards the valve body when brazing the three joints.
10. Remove the thermal paste residue and dry the valve body thoroughly. Install the valve body into the coil.

Note: If necessary, use an adjustable pliers to carefully install the valve body into the coil. DO NOT depress on the top of the valve body. See photo.



11. Remove the old drier by unbrazing or cutting the condenser loop (halo) as close as possible to the drier. Install the new drier assembly (part # WR86X93).

Note: If necessary, use the condenser loop extension tubing (part # WR97X238).

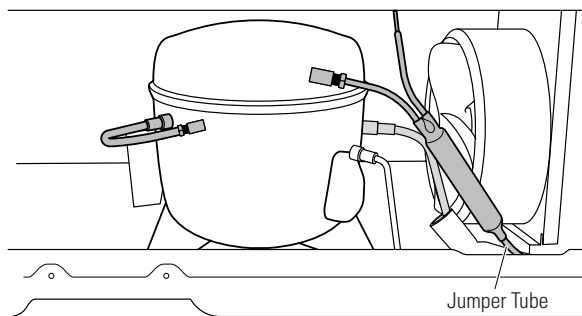

12. Install the process valve (part # WJ56X61). Clean and inspect all joints.
13. Evacuate and charge the system. Use original factory charge quantity of R-134a. (See **Evacuation and Charging Procedure.**)
14. Reinstall the rear access cover.

CustomCool™ Assembly

Note: Refer to Service Guide #31-9075 for complete instruction on servicing CustomCool™ components.

The following components must be removed in the appropriate order to access the CustomCool assembly.

1. Remove the 2 bottom freezer baskets.
2. Remove the recessed Phillips-head screw that attaches the CustomCool inlet. Pull the inlet out of the freezer wall.



3. Access the fresh food evaporator. (See **Fresh Food Evaporator**, follow steps 1 through 6.)
4. Carefully lift and pull the fresh food evaporator forward.
5. Slide the drain trough to the right and remove it from under the evaporator.



Note: When installing the drain trough, insure trough outlet is inserted into the drain funnel.

(Continued next page)

6. Remove the support from under the evaporator tubing.
7. Remove the 3 Phillips-head screws that hold the CustomCool™ unit to the bottom of the refrigerator compartment.

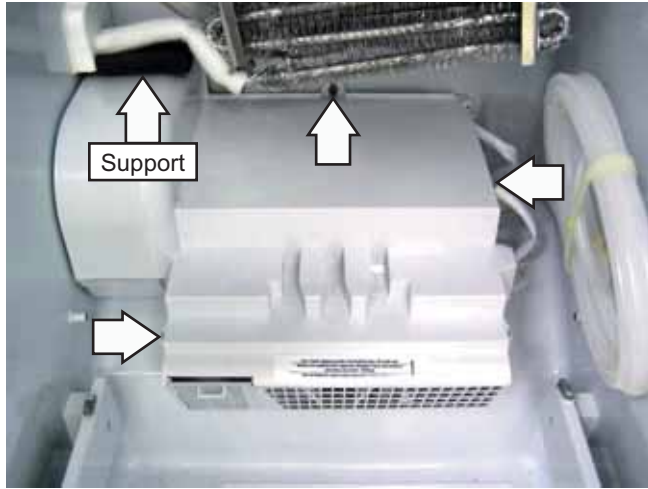

8. Move the unit to the right, then carefully pull the left side towards the front of the refrigerator.



9. Place the unit vertically on its right side.
10. Peel back the foam seal from the left side and the tape from the rear of the unit.



11. Release the 3 tabs and remove the cover.



CustomCool™ Components

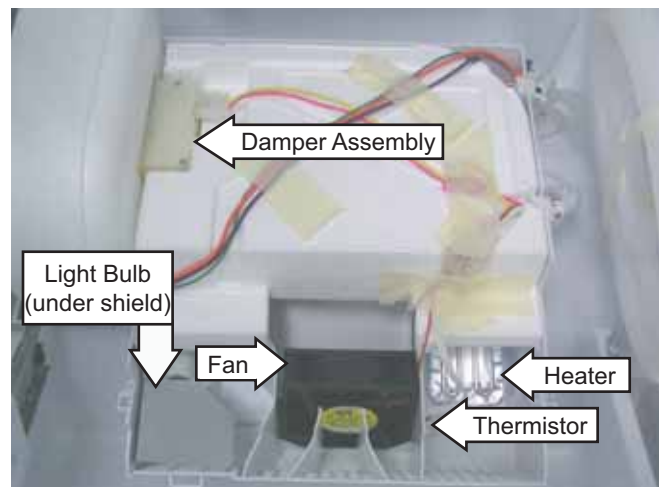

Dispenser Assembly

The dispenser assembly consists of the interface, display board, dispenser shield, and duct door functioning parts. The dispenser interface can be removed to access the display board and the dispenser shield mounting screws. The interface is held in place by 4 tabs that hold it to the dispenser recess. To remove the interface, it is necessary to grasp the bottom lip of the interface on either side and gently pull it towards you. There are 3 wire harnesses connected to the display board.

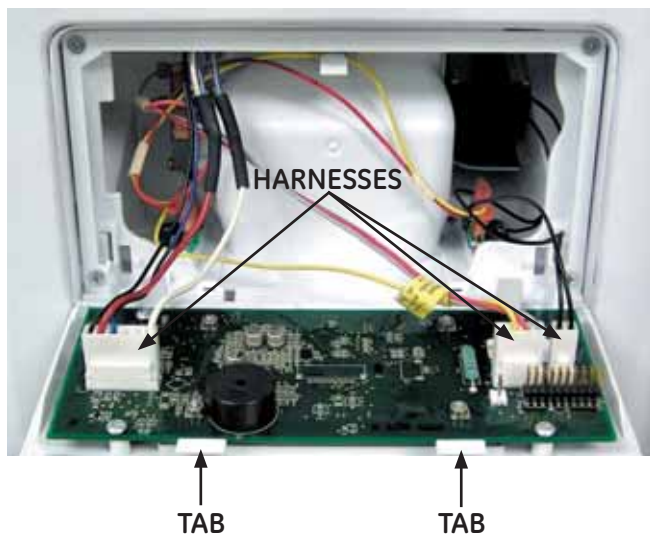
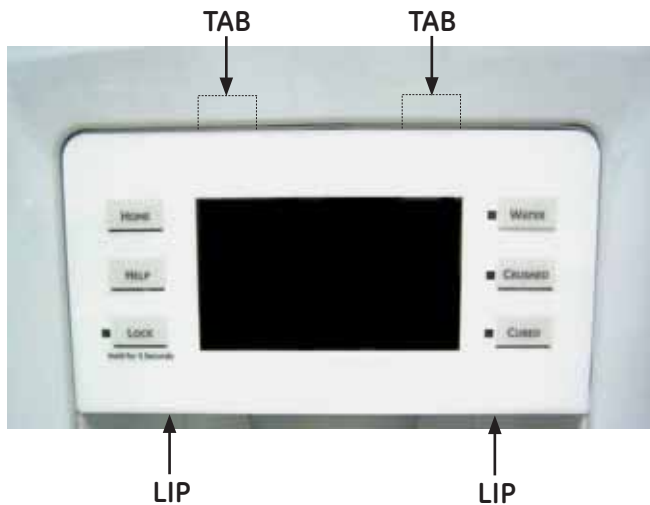

Note: The interface and display board are replaced as a complete assembly.

When assembling, insert top tabs into the top of dispenser recess first, then snap the bottom into place.

The dispenser shield can be removed to access the cradle switch, duct door, duct door solenoid, and dispenser LED lights. The dispenser shield is attached to the dispenser recess with 4 Phillips-head screws.

Note: The dispenser LED lights cannot be replaced individually. The dispenser shield and LED lights are replaced as an assembly. Check model number for correct assembly.

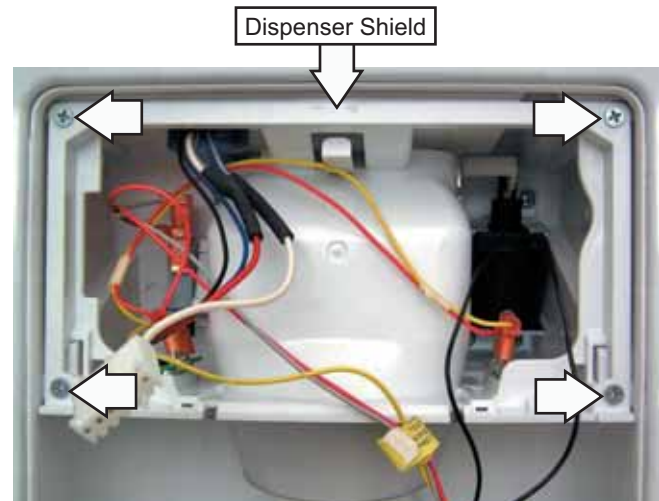

Bottom View of Dispenser Shield



Dispenser Shield Removed



Precise Fill

The Precise Fill mode allows the user to select a specific volume to be dispensed in either cups, ounces, pints, or liters.

Overview

The Precise Fill design places a flowmeter between the water valve and the dispenser to measure water flow through the system. The flowmeter sends a signal to the main control board. The main control interprets the signal, turning the water valve off at the appropriate time. The quantity dispensed is displayed on the dispenser board.

When the dispenser is activated, the flow of water through the meter rotates a paddle. The paddle contains a magnet which passes by a sensor within the flowmeter. The sensor counts the number of revolutions and sends that information to the main control board. For example, 1 Cup = Nr (number of revolutions). The main control board cycles the water valve relay based on the information.

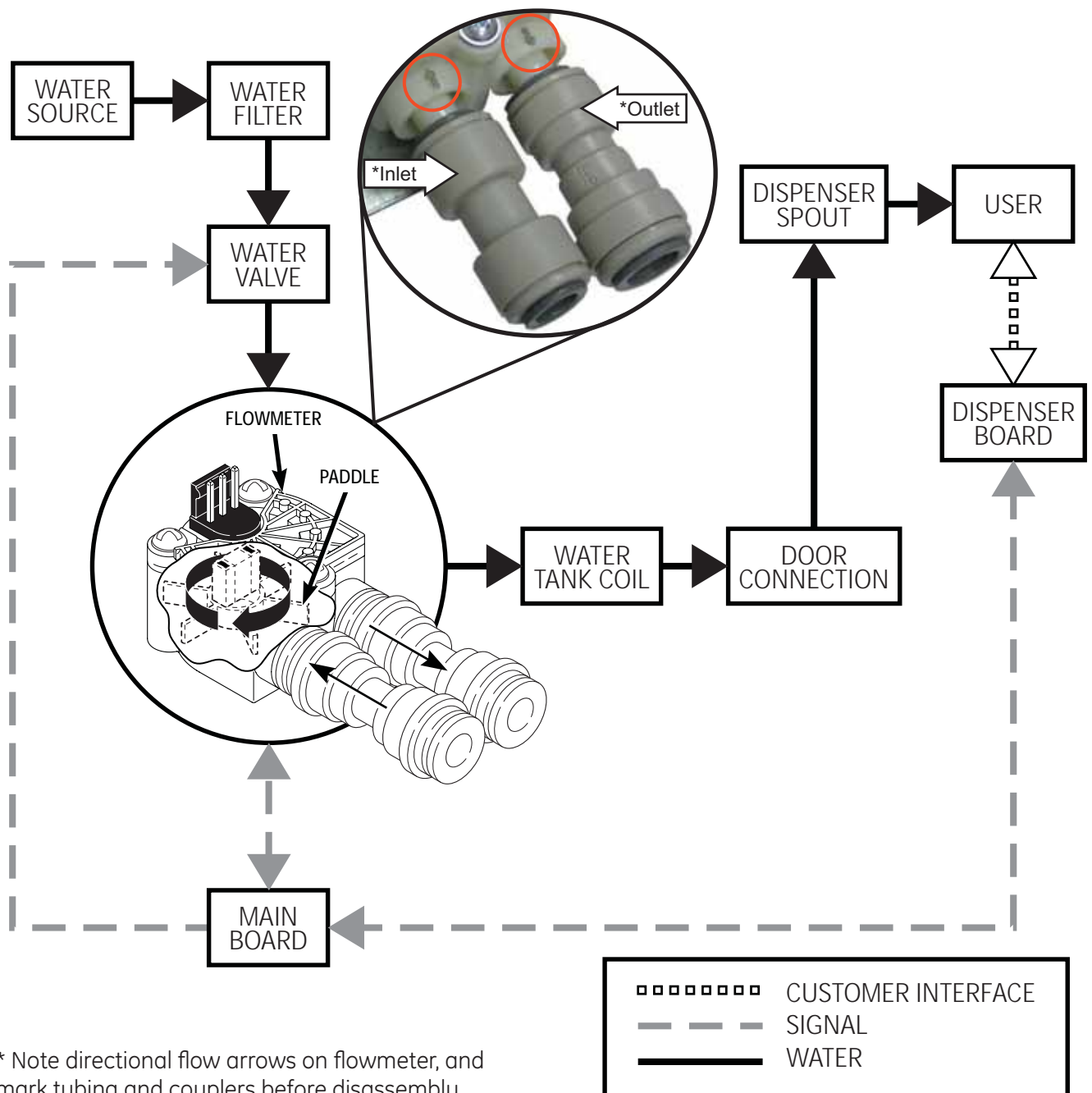

* Note directional flow arrows on flowmeter, and mark tubing and couplers before disassembly.

Flowmeter

The flowmeter is located in the machine compartment behind the water valve. The water valve must be removed to access the flowmeter.

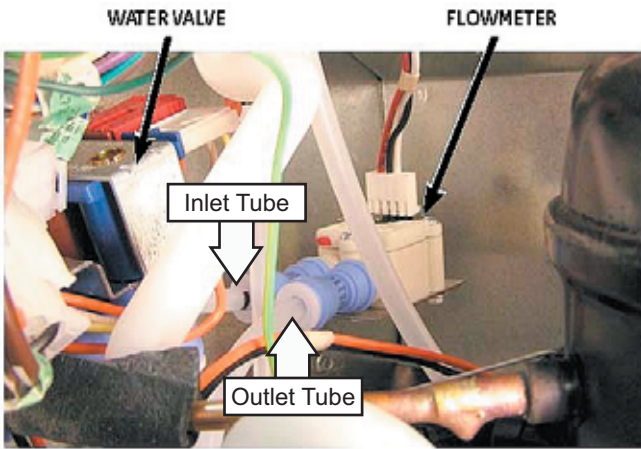

To remove the flowmeter:

Caution: It may be necessary to bend the process tube in order to remove the water valve. If it is necessary to bend the process tube, use extreme caution.

1. Remove the ¼-in. hex-head screw that holds the water valve to the cabinet.
2. Lift and move the valve to the right to disengage the tab at the top of the valve.

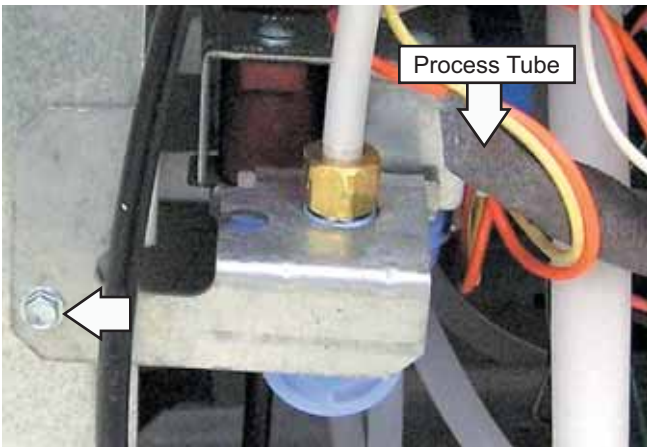

Note: The flowmeter is attached to a mounting bracket that is held to the cabinet with a ¼-in. hex-head screw and 2 tabs.

3. Remove the ¼-in. hex-head screw from the flowmeter bracket.

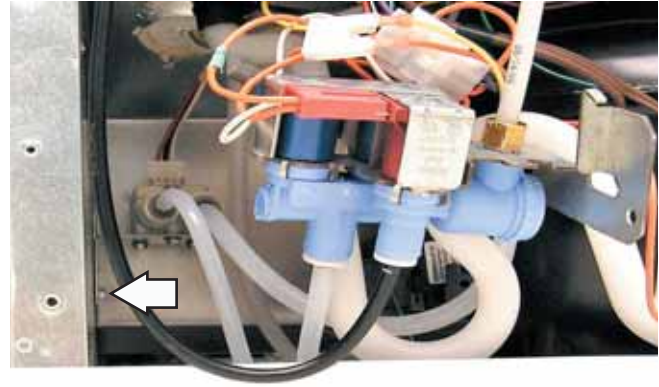

4. Lift and rotate the flowmeter bracket counterclockwise to disengage the 2 tabs at the top of the bracket.
5. Carefully pull out the bracket and flowmeter.
6. Disconnect the water lines from the flowmeter.
7. Disconnect the wire harness from the flowmeter.
8. Remove three ¼-in. hex-head screws from the mounting bracket.

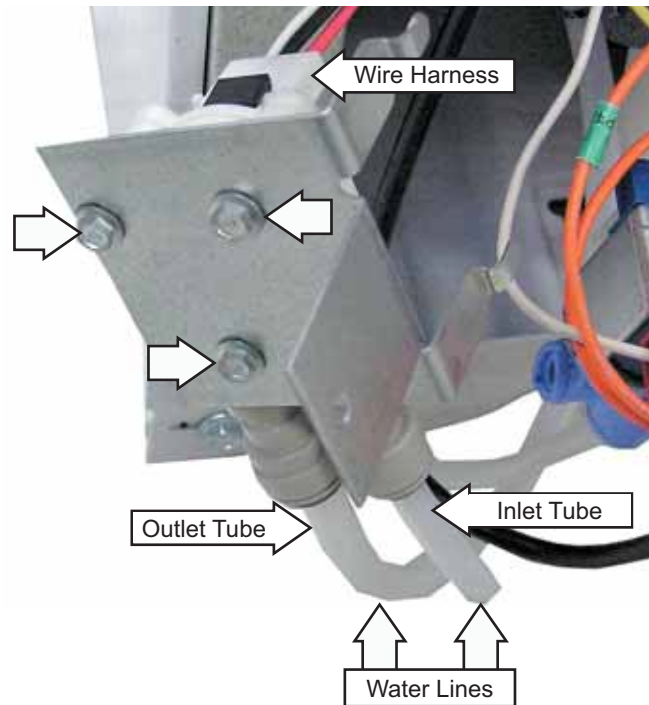

Note:

- When replacing or repairing the water line tubing, ensure the end of the tubing is cut square and fully inserted into the water valve and flowmeter.
- Do not discard mounting bracket. The mounting bracket is not available as a replacement part.

Troubleshooting

Control Diagnostics Using LCD Screen

The LCD screen has a self-diagnosis mode that can be accessed and will assist the technician to test certain functions of the LCD screen, dispenser, and interior fans. This mode can aid the service technician in quickly identifying failed or improper operation of certain components and systems.

Control diagnostics using the LCD screen do not use error codes to identify problems. Instead, the LCD screen displays a list of components or systems to be checked if a problem is detected.

To enter the self-diagnosis mode, press and hold in the **HOME**, **CRUSHED**, and **WATER** pads. The **SELF DIAGNOSIS** screen will appear. Press **SOFTWARE VERSION**, **FACTORY TEST**, or **HMI TEST**. Select **EXIT** to exit the self diagnosis mode.



Self Diagnosis	Description
SOFTWARE VERSION	Verifies using latest main and HMi board software. Test EEprom status.
FACTORY TEST	All Fans - turns on ALL interior fans (fresh food, freezer, beverage center, and QuickFreeze™ fans). Calibrate - calibrates the touch screen assembly of LCD screen Scan Screen - Starts LCD screen quality scan. Operates the water, crushed, cube, and lock LEDs. Opens and closes dispenser duct door and turns dispenser light LEDs on and off. Back - Returns to Self Diagnosis screen.
HMI TEST	Operates all pad LEDs, light LEDs, and screen LCD. Opens dispenser duct door. Press any pad or the glass cradle to check switch contact.
EXIT	Returns refrigerator back to normal mode.

Diagnostics Aid Kit

The diagnostic aid kit may assist the technician to functionally test individual components.

A diagnostic aid kit can be assembled and consists of a key pad temperature control assembly and wire harness. The parts required are WR55X10390 and WX05X14999.

Using the kit, diagnostics can be performed by removing the base grill and plugging into the diagnostic aid wire harness located on the left side. Diagnostics can also be performed by accessing the main board on the back of the refrigerator and plugging into the harness extended from the board.

Note: After plugging in the diagnostic aid kit, if the display is blank, press and release any of the temperature pads. The display will show actual temperatures.

Diagnostic Aid - Front Access



Diagnostic Aid - Main Board Access



Enter the diagnostic mode by pressing both the freezer temperature (COLDER and WARMER) pads and the refrigerator temperature (COLDER and WARMER) pads simultaneously. All four pads must be held for approximately 3 seconds. Blinking "0"s in both displays indicate the refrigerator has entered the test mode. Remove fingers within 5 seconds and press any middle pad to lock-in the test mode. The blinking "0"s will change over to solid (non-blinking) "0"s when the test mode is locked in. You can now test specific components using the chart.

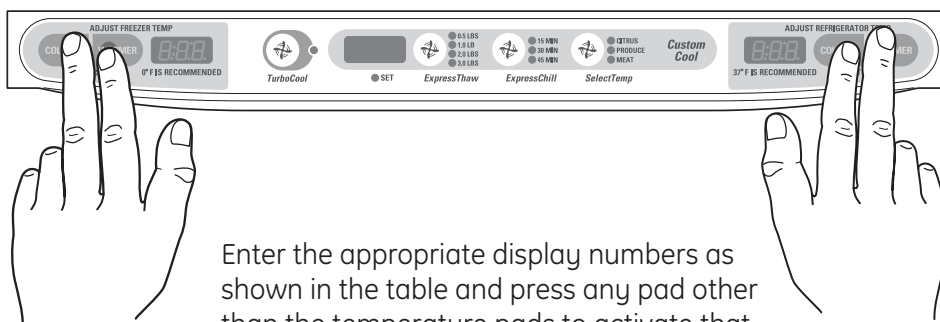

(Continued next page)

Freezer Display	Fresh Food Display	Diagnostics	Results	Comments
0	7	Control and Sensor System Test	Checks each thermistor in order.	See Note 1.
1	0	Dampers Test	Custom Cool™ damper will open, close after 10 seconds, pause briefly, then single damper will open for 10 seconds.	Test will not start for approximately 20 seconds after pad is depressed.
1	1	Fan Test	Cycles through each fan for 5 seconds.	
1	2	100% Run Time	Sealed system on 100% of the time. Times out after 1 hour.	
1	3	Prechill Test	Starts prechill mode. Unit returns to normal on its own.	
1	4	Defrost Test	Toggles on the defrost cycle. See Note 2.	Must press again to turn heater off. See Note 2.
1	5	Main Control Reset/Test Exit	Causes a system reset and exits test mode.	

Note 1: Display order is #1 = Fresh Food Evaporator Thermistor, #2 = Fresh Food Thermistor, #3 = CustomCool™ Thermistor, #4 = Freezer Evaporator Thermistor, #5 = Freezer Thermistor.

Thermistor test results are: P = Pass, 0 = Fail, S = Short to 5 VDC, B = Defective board (replace main control).

Note 2: You **must** enter the defrost test again to toggle the defrost heater off at the end of the test. The heater will not come on if the evaporator thermistor is above 70°F (21°C).

Control Board Connector Locator

Main Control Board

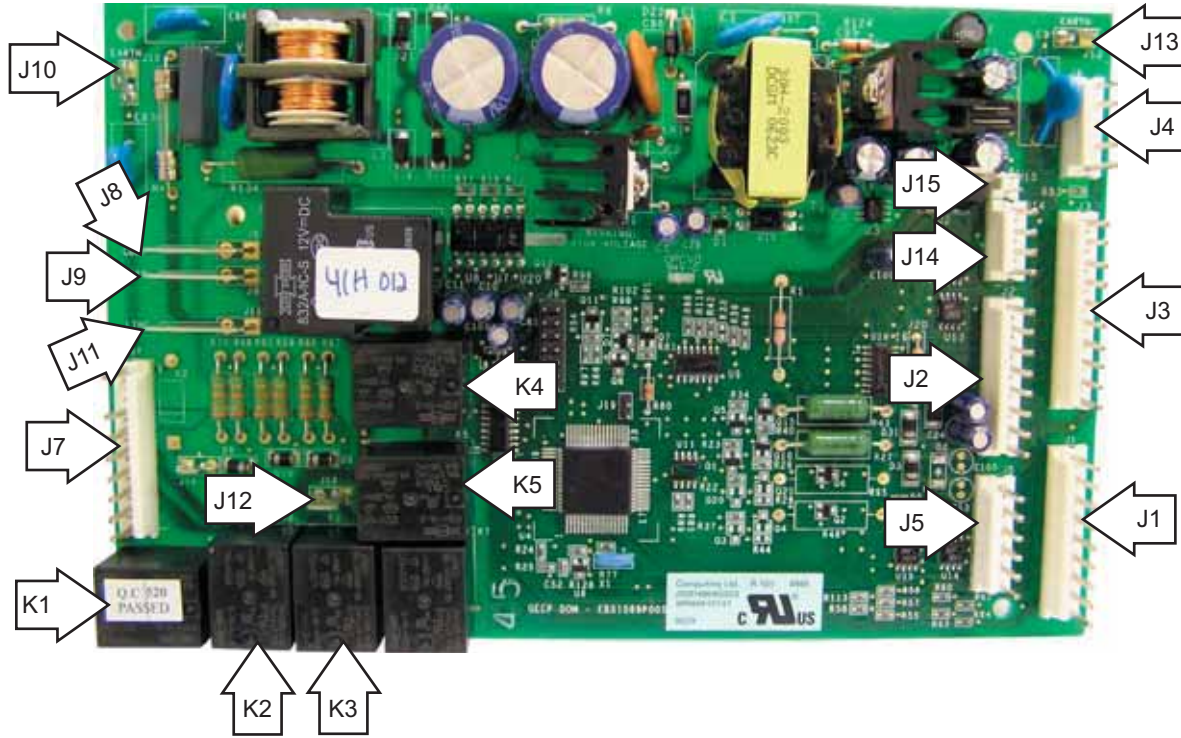

J10 and J13 - Earth (Ground)

J8 - Line (L1) to AC Compressor*

J9 - Defrost Heater

J11 - Line (L1)

J7 - Neutral, Door Switches, CustomCool™ Heater, Water Valve, Cube Solenoid, Auger Motor

J12 - Duct Heater

K1 - Auger

K2 - Crusher

K3 - Water

K4 - Defrost

K5 - CustomCool™

J4 - LCD Board

J3 - QuickFreeze™ Fan, Beverage Center Fan, 3-way Valve

J1 - Fresh Food Thermistor, Freezer Thermistor, Fresh Food Evaporator Thermistor, Freezer Evaporator Thermistor, Model Selector

J14 - Flow Meter

J15 - Inverter**

J2 - Fan Common, Evaporator Fan, Condenser Fan, Fresh Food Fan, CustomCool™ Fan, Model Selector

J5 - CustomCool™ Damper(s), CustomCool™ Thermistor

* Single-speed compressors only

** 3-speed compressors only

Some of the low-voltage DC connector labeling on this model may differ from other models. The function and diagnostics for these connectors are identical for all models.

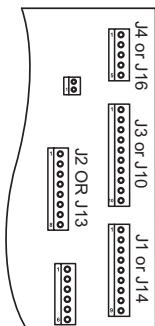

(Continued next page)

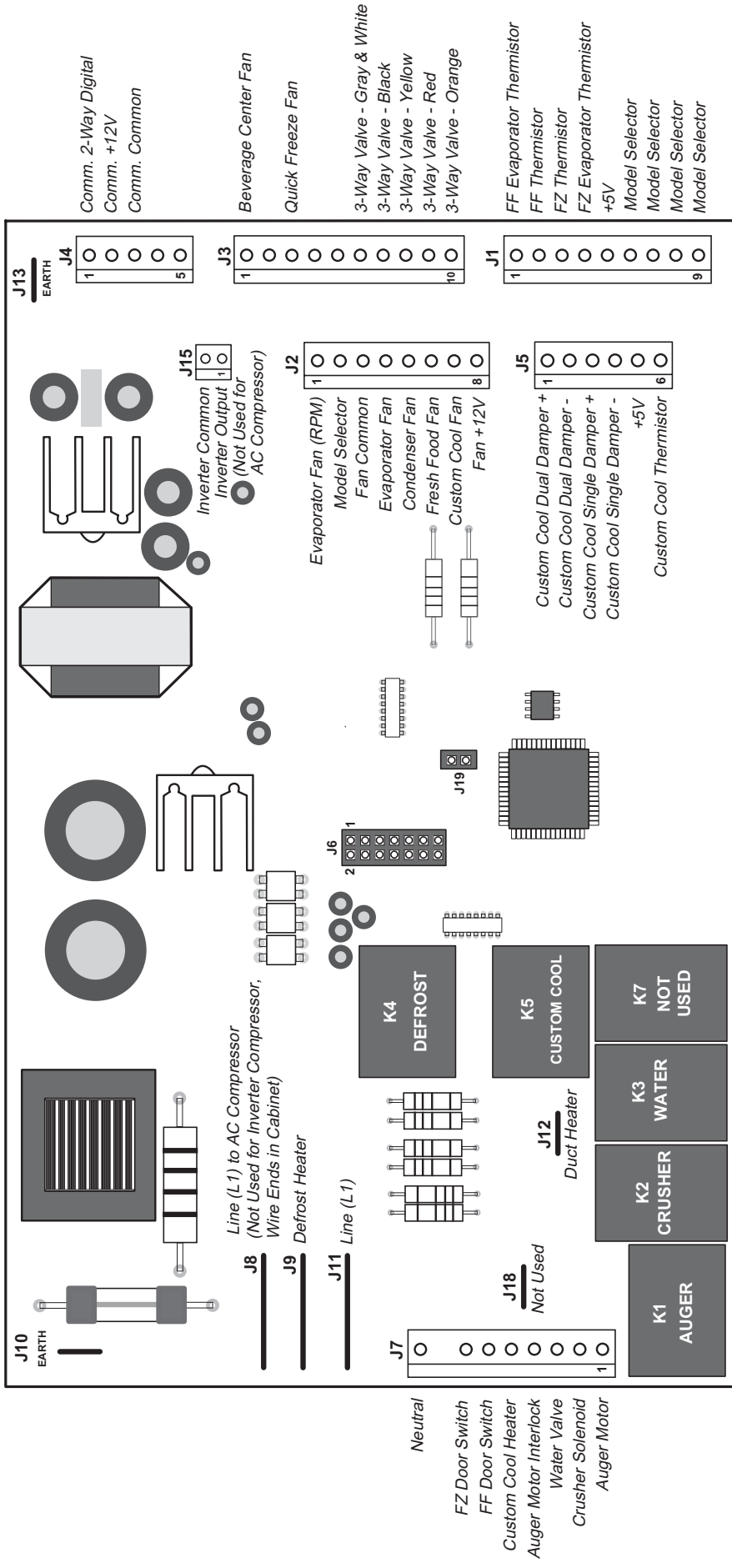

MAIN CONTROL BOARD TROUBLESHOOTING

The main control board is located at the back of the refrigerator, above the machine compartment on the right-hand side. (See *Control Board Connector Locator*.)

CONTROL BOARD PIN DEFINITIONS				
CONNECTOR	PIN	INPUT	OUTPUT	FUNCTION
J1	1	VDC		Feedback of fresh food evaporator thermistor value. Thermistor value is NTC (when temperature drops, resistance value increases), causing return voltage reduction. This value is used to cycle fresh food evaporator fan, compressor, and condenser fan. Feedback is filtered to respond to 8 degrees of change per minute.
J1	2	VDC		Feedback of fresh food thermistor value. Thermistor value is NTC (when temperature drops, resistance value increases), causing return voltage reduction. This value is used to cycle fresh food evaporator fan, compressor, and condenser fan. Feedback is filtered to respond to 8 degrees of change per minute.
J1	3	VDC		Feedback of freezer thermistor value. Thermistor value is NTC (when temperature drops, resistance value increases), causing return voltage reduction. This value is used to cycle freezer evaporator fan, compressor, and condenser fan, and will not cycle fresh food fan. Feedback is filtered to respond to 8 degrees of change per minute.
J1	4	VDC		Feedback of freezer evaporator thermistor value. Thermistor value is NTC (when temperature drops, resistance value increases), causing return voltage reduction. This thermistor value is used to cycle the defrost heater on during defrost when temperature is below defrost value and off when the temperature is above defrost value. This value is also read during power-up to determine if refrigerator goes into pulldown mode or cycle continuation. Feedback is unfiltered and responds immediately.
J1	5		VDC	Provides 5 VDC for thermistors.
J1	6		VDC	Model Selector.
J1	7		VDC	Model Selector.
J1	8		VDC	Model Selector.
J1	9		VDC	Model Selector.

(Continued next page)

CONTROL BOARD PIN DEFINITIONS				
CONNECTOR	PIN	INPUT	OUTPUT	FUNCTION
J2	1	Hz		Feedback from evaporator fan. Evaporator fan feedback is not read for this application.
J2	2		VDC	Model pin selection.
J2	3		VDC	Evaporator fan and condenser fan common.
J2	4		VDC	Output to evaporator fan for motor operation. Effective voltage is determined by pulse width modulation.
J2	5		VDC	Output to condenser fan for motor operation. Effective voltage is determined by pulse width modulation.
J2	6		VDC	Common to fresh food fan for motor operation. Switched for pulse width modulation fan speed control. Effective voltage is determined by pulse width modulation.
J2	7		VDC	Switched common to CustomCool™ fan.
J2	8		VDC	Provides 12-VDC supply voltage to all fans, constant voltage.

CONTROL BOARD PIN DEFINITIONS				
CONNECTOR	PIN	INPUT	OUTPUT	FUNCTION
J3	1		VDC	Output to beverage center fan for motor operation. Effective voltage is determined by pulse width modulation.
J3	3		VDC	Output to QuickFreeze™ fan for motor operation. Effective voltage is determined by pulse width modulation.
J3	6		VDC	3-Way valve.
J3	7		VDC	3-Way valve.
J3	8		VDC	3-Way valve.
J3	9		VDC	3-Way valve.
J3	10		VDC	3-Way valve.

CONTROL BOARD PIN DEFINITIONS				
CONNECTOR	PIN	INPUT	OUTPUT	FUNCTION
J4	1	DIGITAL Communication	DIGITAL Communication	2-way communication between main control board and LCD board.
J4	2		VDC	12-VDC supply.
J4	3		VDC	DC common.

CONTROL BOARD PIN DEFINITIONS

CONNECTOR	PIN	INPUT	OUTPUT	FUNCTION
J5	1	VDC	VDC	ExpressChill (CustomCool™) damper.
J5	2	VDC	VDC	ExpressChill (CustomCool™) damper.
J5	3	VDC	VDC	ExpressChill (CustomCool™) damper.
J5	4	VDC	VDC	ExpressChill (CustomCool™) damper.
J5	5		VDC	Provides 5 VDC for ExpressChill (CustomCool™) thermistor.
J5	6	VDC		Feedback of ExpressChill™ (CustomCool™) thermistor. Thermistor is NTC (when temperature drops, resistance value increases), causing return voltage reduction.

CONTROL BOARD PIN DEFINITIONS

CONNECTOR	PIN	INPUT	OUTPUT	FUNCTION
J7	1		VAC	Switched L1 voltage to the auger motor - 120 VAC.
J7	2		VAC	Switched L1 voltage to the cube solenoid - 120 VAC.
J7	3		VAC	Switched L1 voltage to the water valve - 120 VAC.
J7	4	VAC		Receives L1 input from freezer door switch when freezer door is closed.
J7	5		VAC	Switched L1 voltage to the ExpressThaw (CustomCool™) heater - 120 VAC.
J7	6	VAC		Receives L1 input from fresh food door switch when door is open. This input is used for evaporator fan control, liner protection mode calculations, door alarm calculations, and adaptive defrost calculations.
J7	7	VAC		Receives L1 input from freezer door switch when door is open. This input is used for evaporator fan control, liner protection mode calculations, door alarm calculations, adaptive defrost calculations and some door interlock functions. Switch must be closed in door closed position (switch depressed) for dispenser LED light and duct door magnet to energize.
J7	9	VAC		AC neutral in.

CONTROL BOARD PIN DEFINITIONS

CONNECTOR	PIN	INPUT	OUTPUT	FUNCTION
J8	1		VAC	Switched L1 voltage to the compressor - 120 VAC. (Only used on single-speed compressor models.)

(Continued next page)

CONTROL BOARD PIN DEFINITIONS

CONNECTOR	PIN	INPUT	OUTPUT	FUNCTION
J9	1		VAC	Switched L1 voltage to the defrost circuit - 120 VAC. A timer (main control software), counts how long this circuit is energized and uses this information to determine if the next defrost cycle is adaptive or nonadaptive.

CONTROL BOARD PIN DEFINITIONS

CONNECTOR	PIN	INPUT	OUTPUT	FUNCTION
J11	1	VAC		Constant L1 voltage to control board circuits - 120 VAC input potential for switched L1 terminals.

CONTROL BOARD PIN DEFINITIONS

CONNECTOR	PIN	INPUT	OUTPUT	FUNCTION
J12	1	VAC		Switched L1 voltage to the duct heater - 120 VAC.

CONTROL BOARD PIN DEFINITIONS

CONNECTOR	PIN	INPUT	OUTPUT	FUNCTION
J15	1		VDC	Output voltage to the compressor inverter - 4 to 6 VDC from J15 pin 1 to J15 pin 2. (Only used on inverter compressor models.)
J15	2		VDC	

**Main Control Board
J2 Connector (Low-Voltage DC Side)**

Pin	Wire Color	Component Termination	Input/Output	Pin-to-Pin Voltage Reading
1	Blue	Evaporator fan tachometer	Input	Not applicable to this model.
2	Blue/White	Model	Input	J2 pin 2 to pin 3 = 12 VDC
3	White/Silver	Fan Common	Common	J2 pin 3 to pin 8 = 12 VDC
4	Yellow/Black	Evaporator fan	Output	J2 pin 4 to pin 3 = 9.5 VDC (high), 8 VDC (med), 6.5 (low)
5	Yellow	Condenser fan	Output	J2 pin 5 to pin 3 = 10.5 VDC (high), 7.5 VDC (med), 5.5 VDC (low)
6	Black/White	Fresh food fan	Common	J2 pin 6 to pin 8 = 12 VDC (high), 10 VDC (med), 9 VDC (low)
7	Tan	CustomCool™ fan	Common	J2 pin 7 to pin 8 = 12 VDC
8	Red	Fan supply voltage (12 VDC)	Output	J2 pin 8 to pin 3 = 12 VDC

**Main Control Board
J3 Connector (Low-Voltage DC Side)**

Pin	Wire Color	Component Termination	Input/Output	Pin-to-Pin Voltage Reading
1	Red/Yellow	Beverage center fan	Input	J3 pin 1 to J2 pin 8 = 12 VDC
3	Black	QuickFreeze™ fan	Input	J3 pin 3 to J2 pin 8 = 12 VDC
6	White/Gray	3-way valve	The 3-way valve coil receives 12-VDC pulses from the main board to change the position of the valve. The pulses come too quickly to measure with a volt meter. For test procedure see 3-Way Valve .	
7	Black	3-way valve		
8	Yellow	3-way valve		
9	Red	3-way valve		
10	Orange	3-way valve		

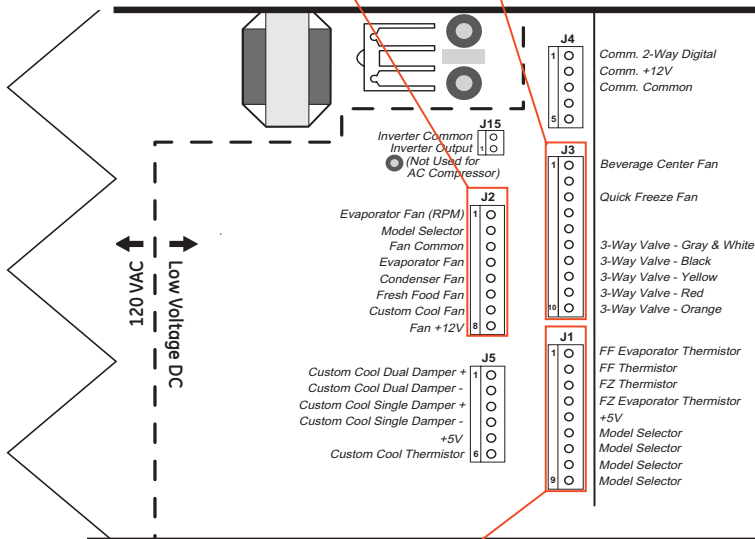

**Main Control Board
J1 Connector (Low-Voltage DC Side)**

Pin	Wire Color	Component Termination	Input/Output	Pin-to-Pin Voltage Reading
1	Red/Blue	Fresh food evaporator thermistor	Input	N/A
2	Yellow	Fresh food thermistor	Input	N/A
3	Red/White	Freezer thermistor	Input	N/A
4	Blue/White	Freezer evaporator thermistor	Input	N/A
5	Blue	Thermistor supply voltage (5 VDC)	Output	J1 pin 5 to J2 pin 3 = 5 VDC

(Continued next page)

Main Control Board J4 Connector (Low-Voltage DC Side)

Pin	Wire Color	Component Termination	Input/Output	Pin-to-Pin Voltage Reading
1	Black	Temperature control	Communication	2-way digital communication
2	Red	Temperature control	Output	J4 pin 2 to pin 3 = 12 VDC
3	Blue	Temperature control	Common	J4 pin 2 to pin 3 = 12 VDC

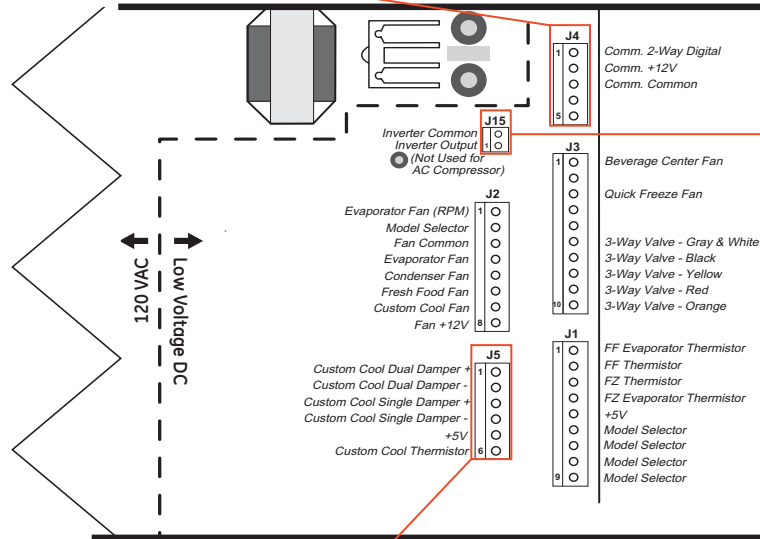

Main Control Board J5 Connector (Low-Voltage DC Side)

Pin	Wire Color	Component Termination	Input/Output	Pin-to-Pin Voltage Reading
1	Pink	ExpressChill™ (CustomCool™) damper	Input/Output	J5 pin 1 to pin 2 = 12 VDC (reversing polarity)
2	Yellow	ExpressChill™ (CustomCool™) damper	Input/Output	J5 pin 2 to pin 1 = 12 VDC (reversing polarity)
3	Brown	ExpressChill™ (CustomCool™) damper	Input/Output	J5 pin 3 to pin 4 = 12 VDC (reversing polarity), if equipped with dual damper
4	Yellow/Black	ExpressChill™ (CustomCool™) damper	Input/Output	J5 pin 4 to pin 3 = 12 VDC (reversing polarity), if equipped with dual dampers
5	White	Thermistor supply voltage (5 VDC)	Output	J5 pin 5 to J2 pin 3 = 5 VDC
6	White	CustomCool™ thermistor	Input	N/A

Main Control Board J15 Connector (Low-Voltage DC Side)

Pin	Wire Color	Component Termination	Input/Output	Pin-to-Pin Voltage Reading
1	Red	Compressor inverter	Output	J 15 pin 1 to J15 pin 2 = 4 to 6 VDC
2	White	Compressor inverter	Output	J 15 pin 2 to J15 pin 1 = 4 to 6 VDC

(Continued next page)

**Main Control Board
J8 Connector (High-Voltage Side)**

Pin	Wire Color	Component Termination	Input/Output	Pin-to-Pin Voltage Reading
J8	Black	Compressor	Output	J8 to J7 pin 9 = 120 VAC

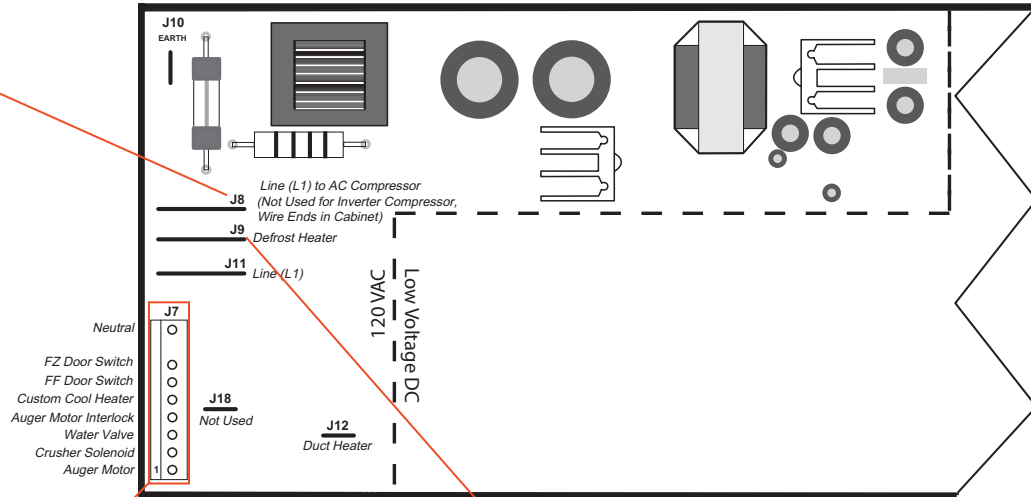

**Main Control Board
J9 Connector (High-Voltage Side)**

Pin	Wire Color	Component Termination	Input/Output	Pin-to-Pin Voltage Reading
J9	Blue	Defrost heater	Output	J9 to J7 pin 9 = 120 VAC

**Main Control Board
J7 Connector (High-Voltage Side)**

Pin	Wire Color	Component Termination	Input/Output	Pin-to-Pin Voltage Reading
1	Beige	Auger	Output	J 7 pin 1 to J7 pin 9 = 120 VAC
2	Silver	Cube solenoid	Output	J 7 pin 2 to J7 pin 9 = 120 VAC
3	Yellow	Dispenser water valve	Output	J 7 pin 3 to J7 pin 9 = 120 VAC
4	Red/White	Freezer door switch	Input	J 7 pin 4 to J7 pin 9 = 120 VAC (Freezer door closed)
5	Blue/White	CustomCool™ heater	Output	J 7 pin 5 to J7 pin 9 = 120 VAC
6	Purple	Fresh food door light switch	Input	J 7 pin 6 to J7 pin 9 = 120 VAC (Fresh food door open)
7	Red	Freezer door light switch	Input	J 7 pin 7 to J7 pin 9 = 120 VAC (Freezer door open)
9	Orange	Neutral	Neutral	Neutral

(Continued next page)

Main Control Board J11 Connector (High-Voltage Side)

Pin	Wire Color	Component Termination	Input/Output	Pin-to-Pin Voltage Reading
J11	Brown	L1 Input	Input	J 11 to J7 pin 9 = 120 VAC

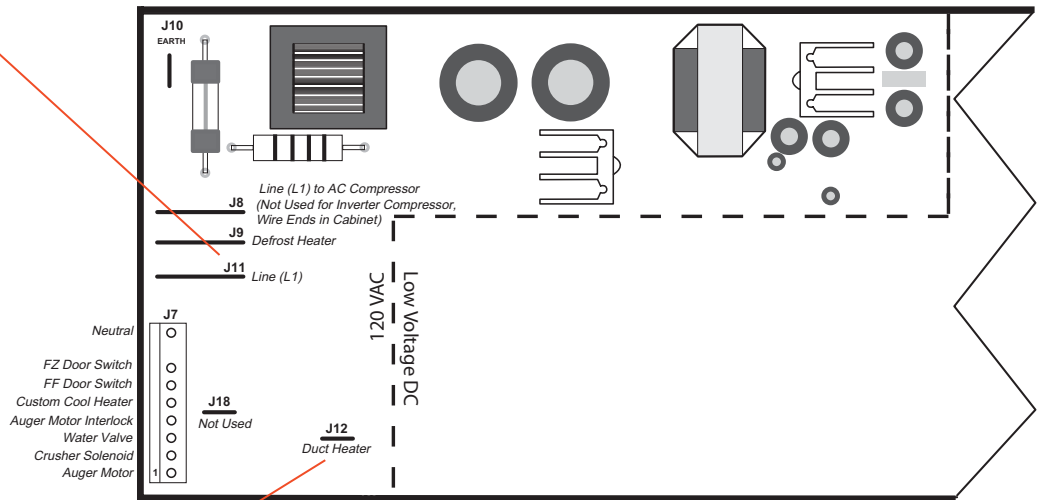

Main Control Board J12 Connector (High-Voltage Side)

Pin	Wire Color	Component Termination	Input/Output	Pin-to-Pin Voltage Reading
J12	Gray	Duct heater	Input	J 12 to J7 pin 9 = 120 VAC

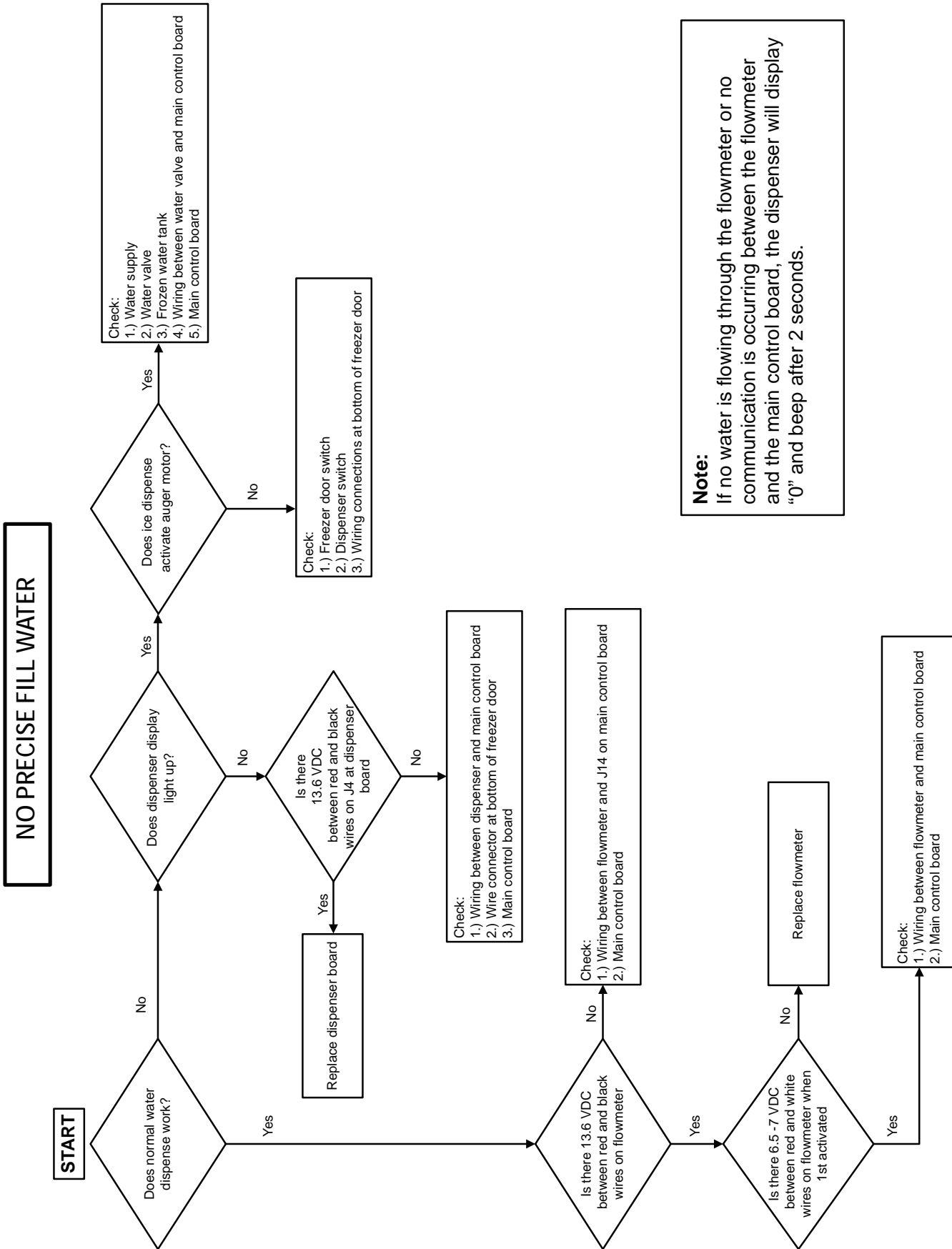

Note:
If no water is flowing through the flowmeter or no communication is occurring between the flowmeter and the main control board, the dispenser will display "0" and beep after 2 seconds.

Icemaker Service Test Mode

The electronic icemaker has a service test mode that can be utilized by the service technician in order to test basic operation of the icemaker. The service test mode consists of a harvest cycle followed immediately by a water fill. The harvest cycle is entered, regardless of icemaker temperature or arm position.

To enter the service test mode:

1. Turn the power switch to the off position and wait 20 seconds. (The green power light will be unlit.)
2. Turn the power switch to the on position. (The green power light will be lit.)
3. Push the feeler arm from the out position to the in position and back again 3 times and only 3 times within 20 seconds.

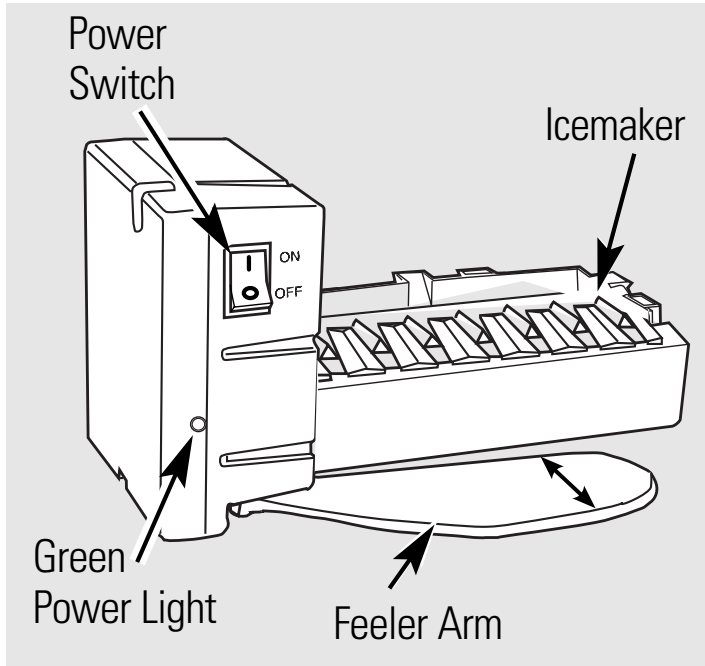

Note: If the icemaker has already started a harvest cycle and the arm is moving, it may be impossible to properly move the arm and enter the service mode without allowing it to reset and powering up again. If the icemaker is allowed to go through its normal harvest cycle, it will take 10-15 minutes after it dumps the ice for water to enter the icemaker.

While in the harvest mode, the heater will remain on for a minimum of 20 seconds. The water fill cycle will initiate the first fill (5.1 seconds) without waiting for the mold to prechill. Only one water fill occurs during the service mode. The icemaker will exit the service test on its own and enter the normal freeze cycle.

Schematic

Single-Speed Compressor Model

Note: This schematic may be different than the one in the Mini-Manual.

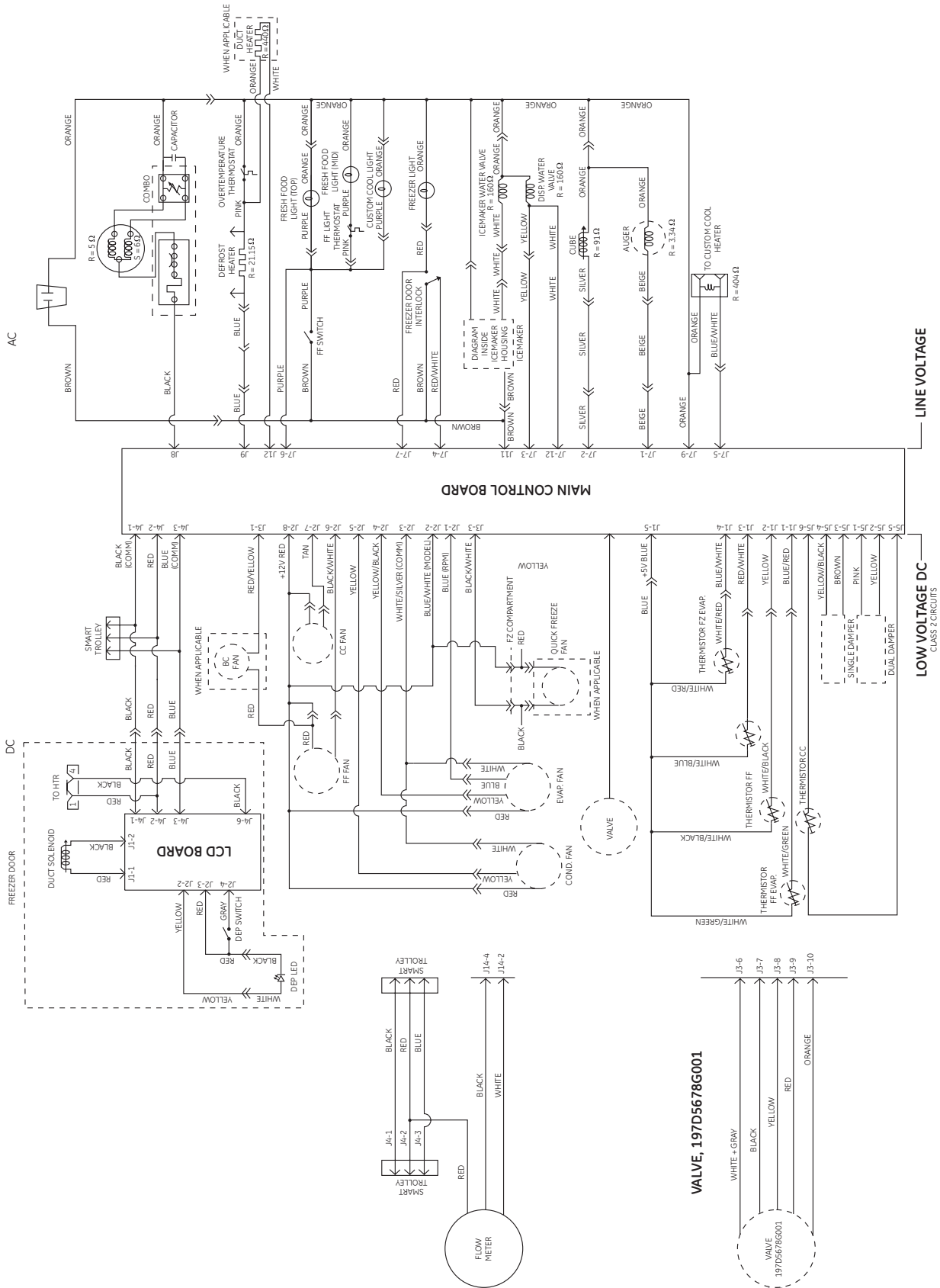

(Continued next page)

Inverter Compressor Model

Note: This schematic may be different than the one in the Mini-Manual.

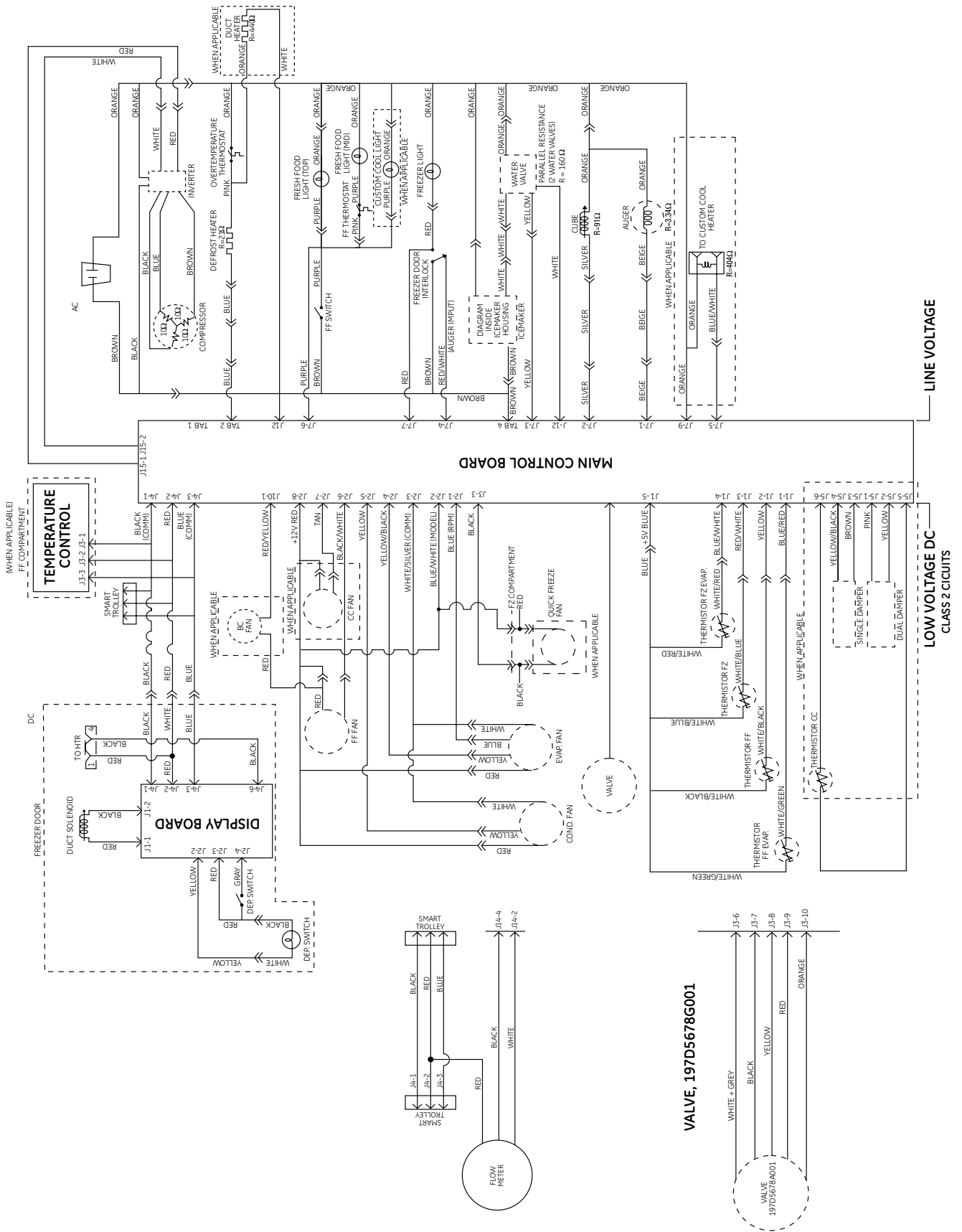

Warranty



All warranty service provided by our Factory Service Centers, or an authorized Customer Care® technician. To schedule service, on-line, 24 hours a day, visit us at ge.com, or call 800.GE.CARES (800.432.2737). Please have serial number and model number available when calling for service.

Staple your receipt here.
Proof of the original purchase date is needed to obtain service under the warranty.

For The Period Of: **GE Will Replace:**

GE and GE PROFILE MODELS:

One Year From the date of the original purchase	Any part of the refrigerator which fails due to a defect in materials or workmanship. During this limited one-year warranty , GE will also provide, free of charge , all labor and related service to replace the defective part.
Thirty Days (Water filter, if included) From the original purchase date of the refrigerator	Any part of the water filter cartridge which fails due to a defect in materials or workmanship. During this limited thirty-day warranty , GE will also provide, free of charge , a replacement water filter cartridge.

GE PROFILE MODELS ONLY:

Five Years (GE Profile models only) From the date of the original purchase	Any part of the sealed refrigerating system (the compressor, condenser, evaporator and all connecting tubing) which fails due to a defect in materials or workmanship. During this limited five-year sealed refrigerating system warranty , GE will also provide, free of charge , all labor and related service to replace the defective part in the sealed refrigerating system.
---	---

What GE Will Not Cover:

- Service trips to your home to teach you how to use the product.
- Improper installation, delivery or maintenance.
- Failure of the product if it is abused, misused, or used for other than the intended purpose or used commercially.
- Loss of food due to spoilage.
- Replacement of house fuses or resetting of circuit breakers.
- Damage caused after delivery.
- Replacement of the water filter cartridge, if included, due to water pressure that is outside the specified operating range or due to excessive sediment in the water supply.
- Replacement of the light bulbs, if included, or water filter cartridge, if included, other than as noted above.
- Damage to the product caused by accident, fire, floods or acts of God.
- Incidental or consequential damage caused by possible defects with this appliance.
- Product not accessible to provide required service.

EXCLUSION OF IMPLIED WARRANTIES—Your sole and exclusive remedy is product repair as provided in this Limited Warranty. Any implied warranties, including the implied warranties of merchantability or fitness for a particular purpose, are limited to one year or the shortest period allowed by law.

This warranty is extended to the original purchaser and any succeeding owner for products purchased for home use within the USA. If the product is located in an area where service by a GE Authorized Servicer is not available, you may be responsible for a trip charge or you may be required to bring the product to an Authorized GE Service location for service. In Alaska, the warranty excludes the cost of shipping or service calls to your home.

Some states do not allow the exclusion or limitation of incidental or consequential damages. This warranty gives you specific legal rights, and you may also have other rights which vary from state to state. To know what your legal rights are, consult your local or state consumer affairs office or your state's Attorney General.

Warrantor: General Electric Company, Louisville, KY 40225