

# Electronic Refrigerator Diagnostics

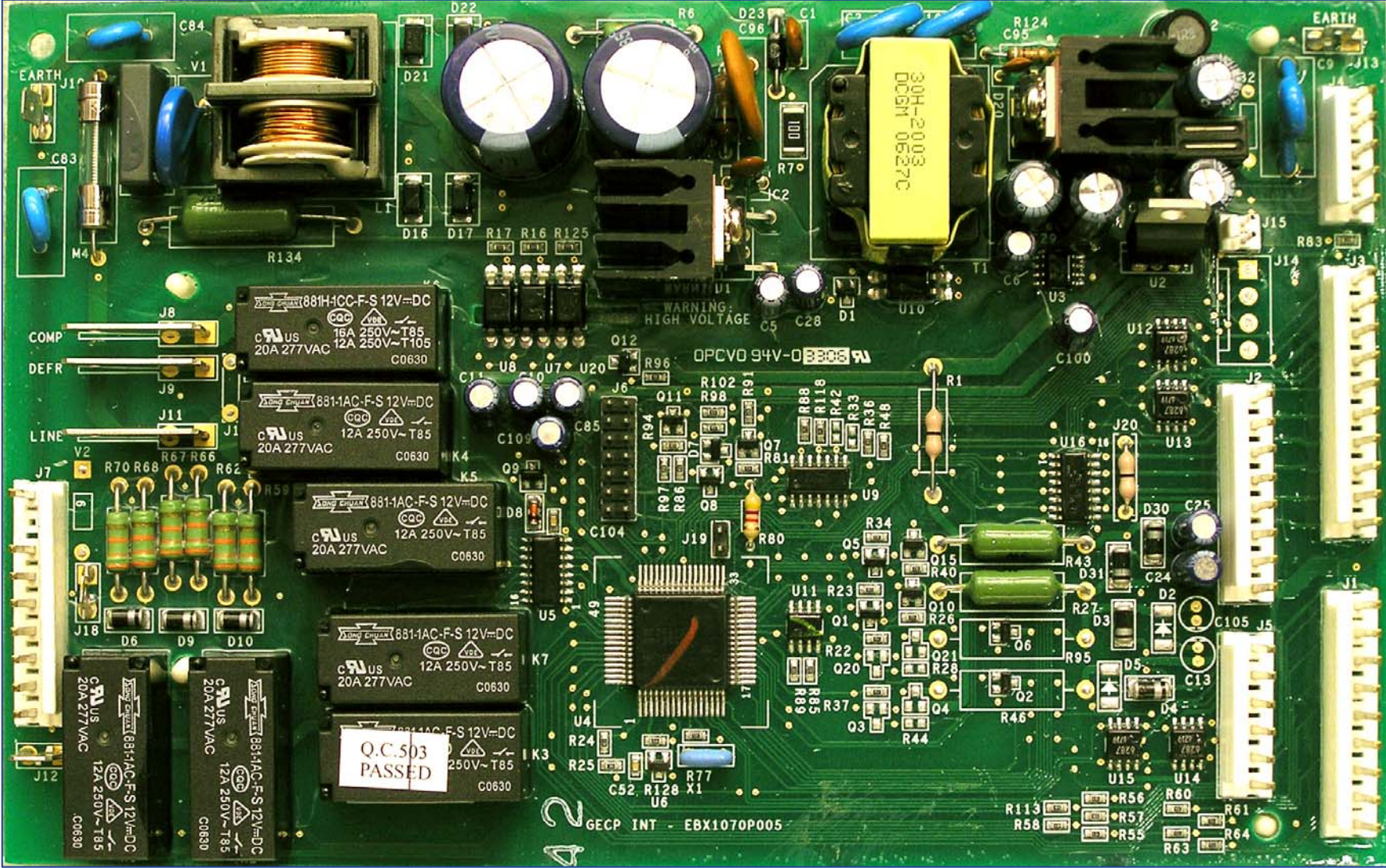

## **IMPORTANT SAFETY NOTICE**

The information in this presentation is intended for use by individuals possessing adequate backgrounds of electrical, electronic, & mechanical experience. Any attempt to repair a major appliance may result in personal injury & property damage. The manufacturer or seller cannot be responsible for the interpretation of this information, nor can it assume any liability in connection with its use.

### **WARNING**

To avoid personal injury, disconnect power before servicing this product. If electrical power is required for diagnosis or test purposes, disconnect the power immediately after performing the necessary checks.

### **RECONNECT ALL GROUNDING DEVICES**

If grounding wires, screws, straps, clips, nuts, or washers used to complete a path to ground are removed for service, they must be returned to their original position & properly fastened.

## Main Electronic Board

**Caution:** When servicing or testing in the main board area, many components and connections are electrically hot to ground. Be sure to use proper service procedures and protective devices.

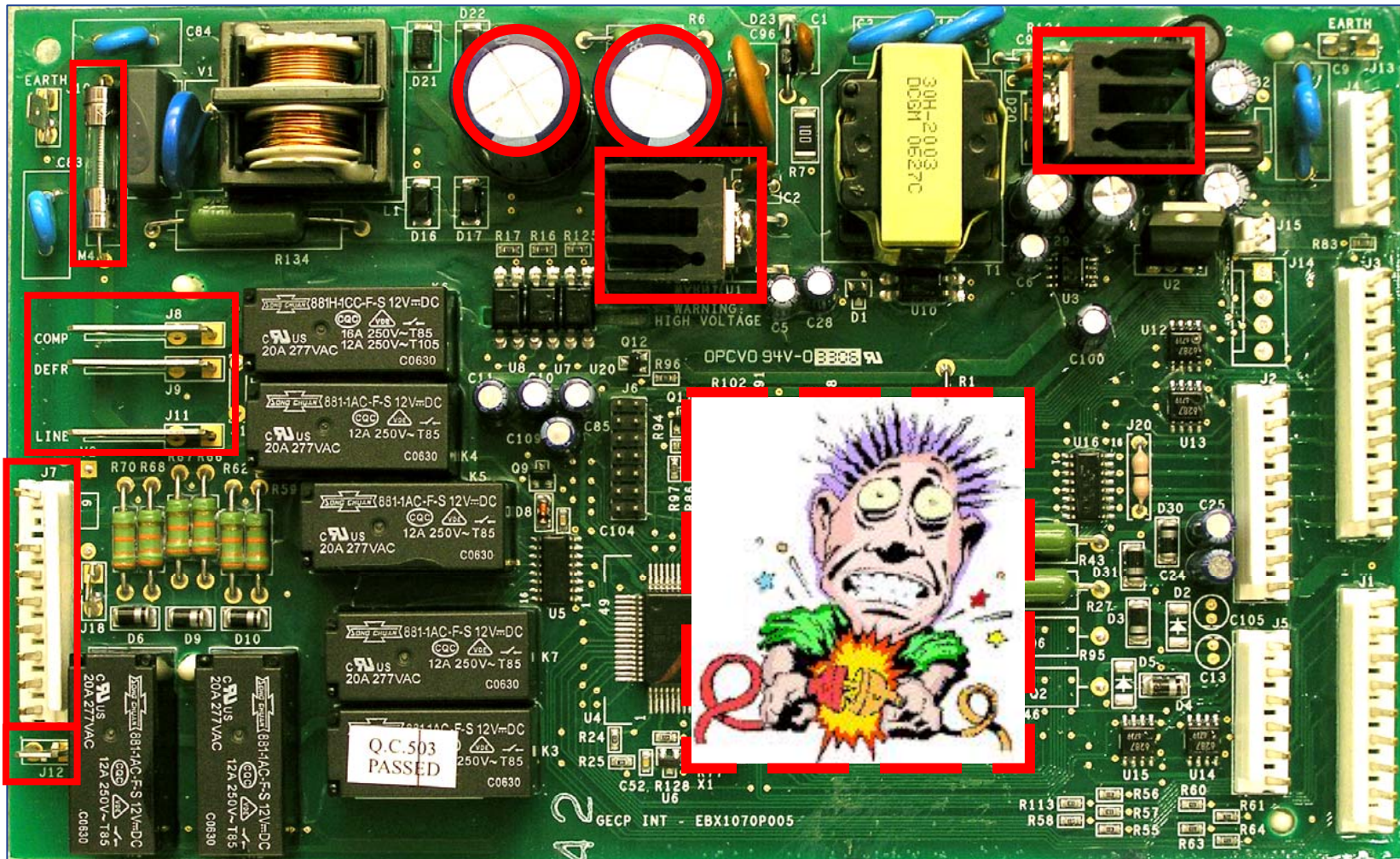

## Electronic Diagnostic Test Mode

All the GE electronic refrigerators have a Diagnostic Mode that is incorporated in the software in each main electronic board. This Diagnostic Mode will test certain components and operate others.

**To activate this diagnostic test feature on an electronic refrigerator, you will need a touch pad control with at least 5 key pads; otherwise you will have to install the additional diagnostic tool.**

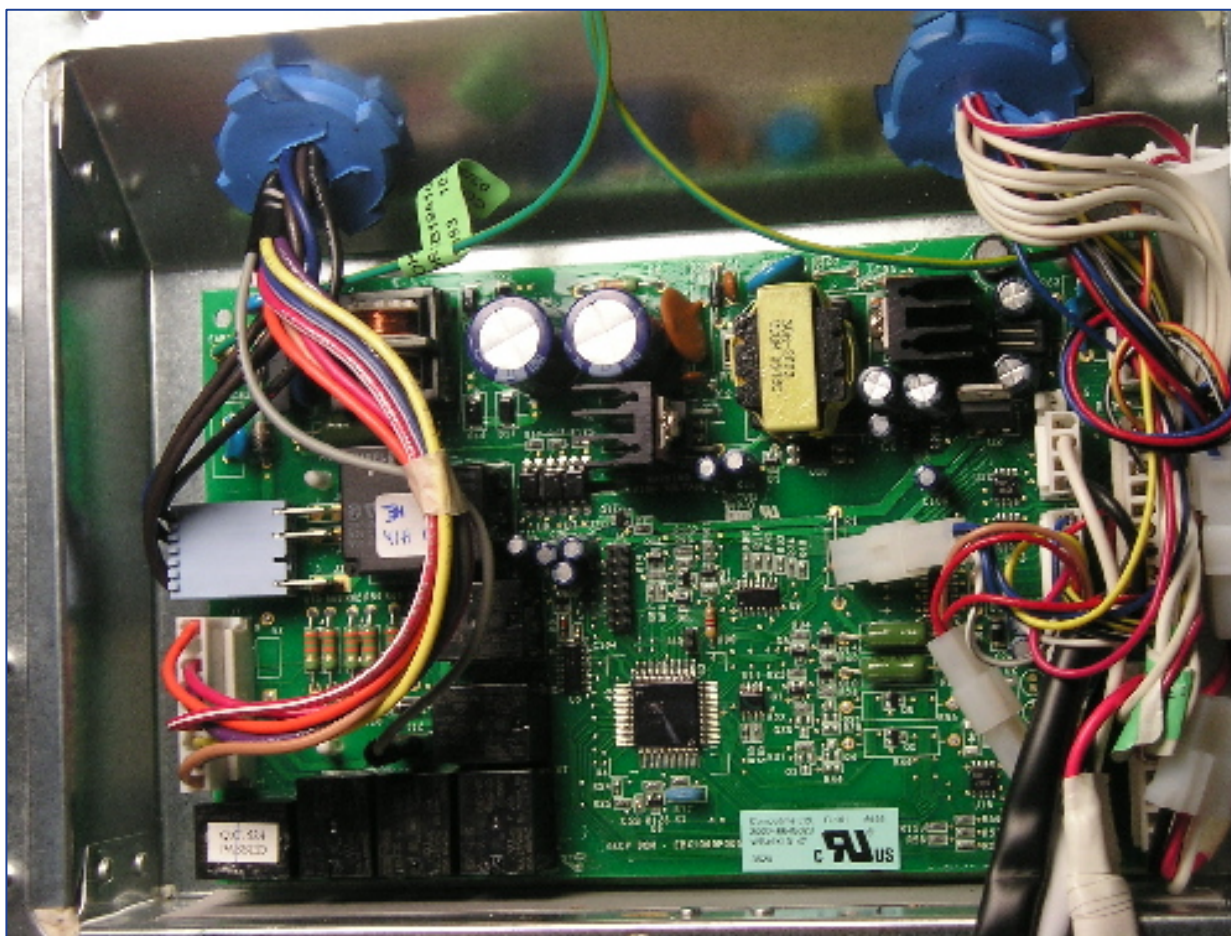

## Diagnostics Aid Kit

The diagnostic aid kit may assist the technician to functionally test individual components.

A diagnostic aid kit can be assembled and consists of a key pad temperature control assembly and wire harness. The parts required are WR55X10390 and WX05X14999.

Using the kit, diagnostics can be performed by removing the base grill and plugging into the diagnostic aid wire harness located on the left side. Diagnostics can also be performed by accessing the main board on the back of the refrigerator and plugging into the harness extended from the board.

**Note:** After plugging in the diagnostic aid kit, if the display is blank, press and release any of the temperature pads. The display will show actual temperatures.

Diagnostic Aid - Front Access



Diagnostic Aid - Main Board Access

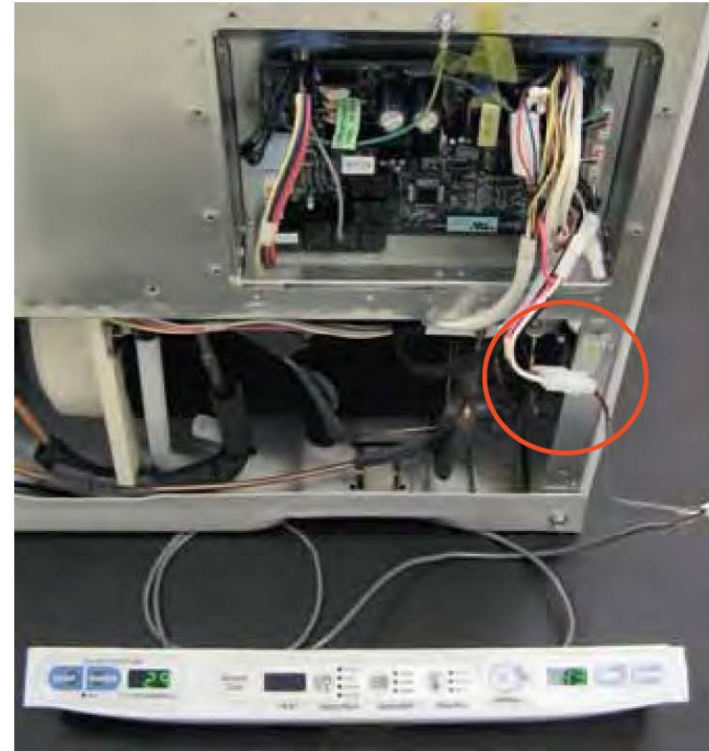

# Electronic Diagnostic Test Mode

## Control Diagnostics

Enter the diagnostic mode by pressing both the freezer temperature (COLDER and WARMER) pads and the refrigerator temperature (COLDER and WARMER) pads simultaneously. All four pads must be held for approximately 3 seconds. Blinking "0"s in both displays indicate the refrigerator has entered the test mode.

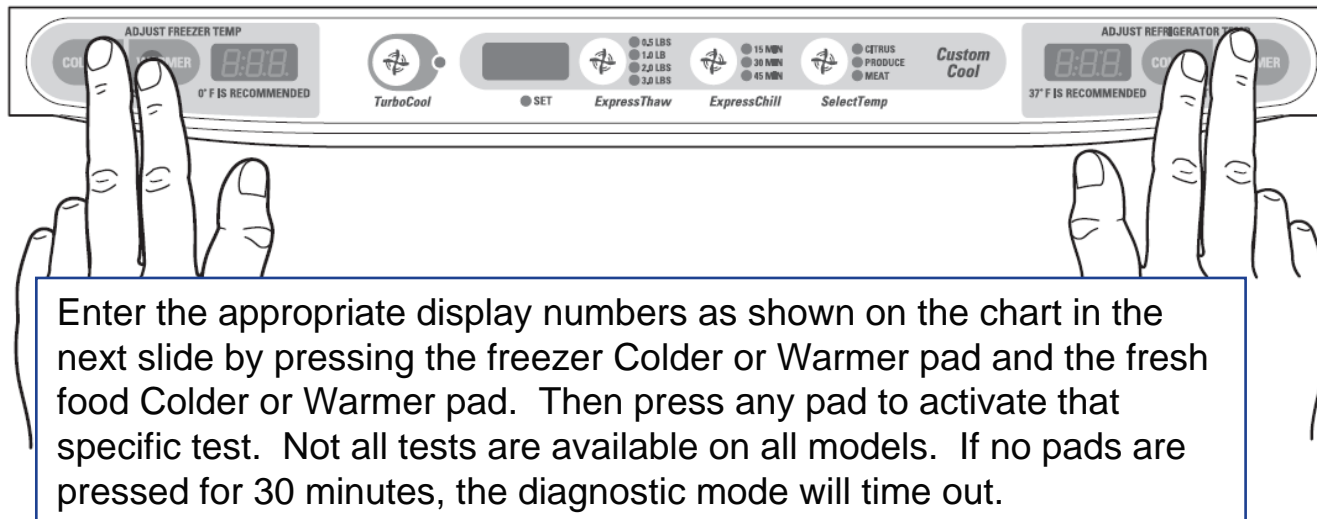

## Electronic Diagnostic Test Mode

Freezer Display	Fresh Food Display	Diagnostics	Results	Comments
0	7	Control and Sensor System Test	Checks each thermistor in order.	See Note 1.
1	0	Dampers Test	Custom Cool™ damper will open, close after 10 seconds, pause briefly, then single damper will open for 10 seconds.	Test will not start for approximately 20 seconds after pad is depressed.
1	1	Fan Test	Cycles through each fan for 5 seconds.	
1	2	100% Run Time	Sealed system on 100% of the time. Times out after 1 hour.	
1	4	Defrost Test	Toggles on the defrost cycle. See Note 2.	Must press again to turn heater off. See Note 2.
1	5	Main Control Reset/Test Exit	Causes a system reset and exits test mode.	

This test will not indicate failure for thermistors out of spec

This test will also cycle the FF damper on single evap models

This test will attempt to turn ON the compressor if it is OFF

**Note 1:** Display order is #1 = Fresh Food Evaporator Thermistor, #2 = Fresh Food Thermistor, #3 = CustomCool™ Thermistor, #4 = Freezer Evaporator Thermistor, #5 = Freezer Thermistor.

Thermistor test results are: P = Pass, 0 = Fail, S = Short to 5 VDC, B = Defective board (replace main control).

**Note 2:** You **must** enter the defrost test again to toggle the defrost heater off at the end of the test. The heater will not come on if the evaporator thermistor is above 70°F (21°C).

# Thermistors





# Main Electronic Board Thermistor Connector J1

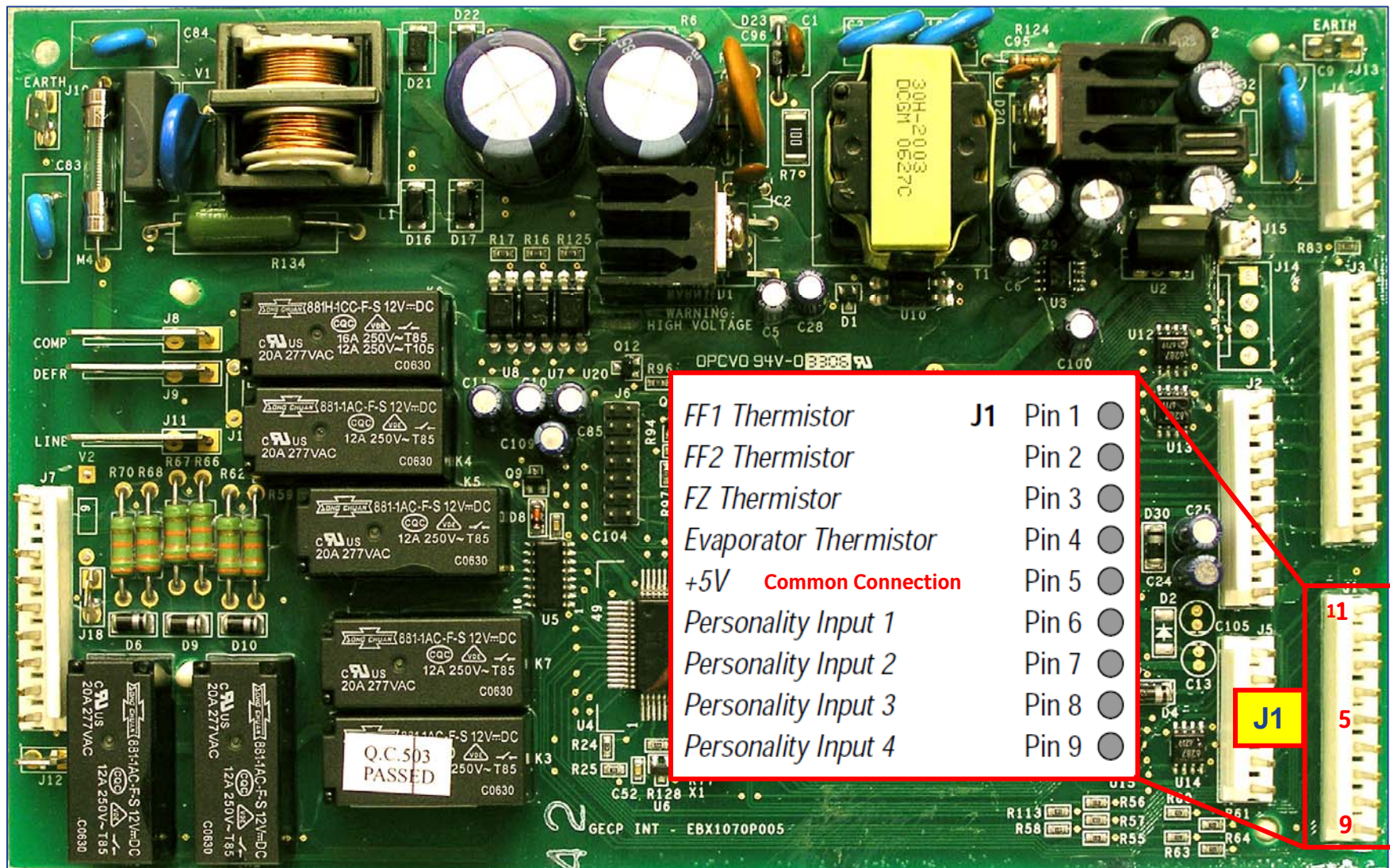

- |                              |                   |
|------------------------------|-------------------|
| <i>FF1 Thermistor</i>        | <b>J1</b> Pin 1 ● |
| <i>FF2 Thermistor</i>        | Pin 2 ●           |
| <i>FZ Thermistor</i>         | Pin 3 ●           |
| <i>Evaporator Thermistor</i> | Pin 4 ●           |
| <b>+5V Common Connection</b> | Pin 5 ●           |
| <i>Personality Input 1</i>   | Pin 6 ●           |
| <i>Personality Input 2</i>   | Pin 7 ●           |
| <i>Personality Input 3</i>   | Pin 8 ●           |
| <i>Personality Input 4</i>   | Pin 9 ●           |

The thermistor connector (J1) is always the 9 pin connector on the edge row connectors regardless of board position.

# Thermistor Operation

A Thermistor is a resistance device designed to react to temperatures. The Thermistors GE uses are called NTC (Negative Temperature Coefficient) type; which means as the temperature decreases, the resistance increases. The main board uses a 5vdc signal to read the Thermistors at the J1 connector.

The main board uses input data from the Thermistors; which are located in the fresh food section, freezer section, and mounted to the freezer evaporator. The main board monitors the Thermistors to determine the temperature in these sections of the refrigerator and determines which components to operate and when to operate them based on this data.



Since there is a separate Thermistor to read the temperature in the fresh food section, freezer section, and to determine the temperature of the evaporator to terminate the defrost cycle; some components work along with a specific Thermistor.

# Thermistor Operation

The components that will operate under normal conditions when the fresh food Thermistor sends data to the main board for a temperature need are the fresh food fan (available on some models), the damper assembly, evaporator fan, the compressor and the condenser fan.

The components that will operate under normal conditions when the freezer Thermistor sends data to the main board for a temperature need are the freezer fan, damper assembly, the compressor, and the condenser fan.

This illustrates that not all components will operate at the same time. It is possible to find the fresh food fan operating all by itself; the damper open, the fresh food fan, and evaporator fan operating without the compressor; or the compressor and condenser fan operating by themselves. It depends on which section of the refrigerator has a temperature need.

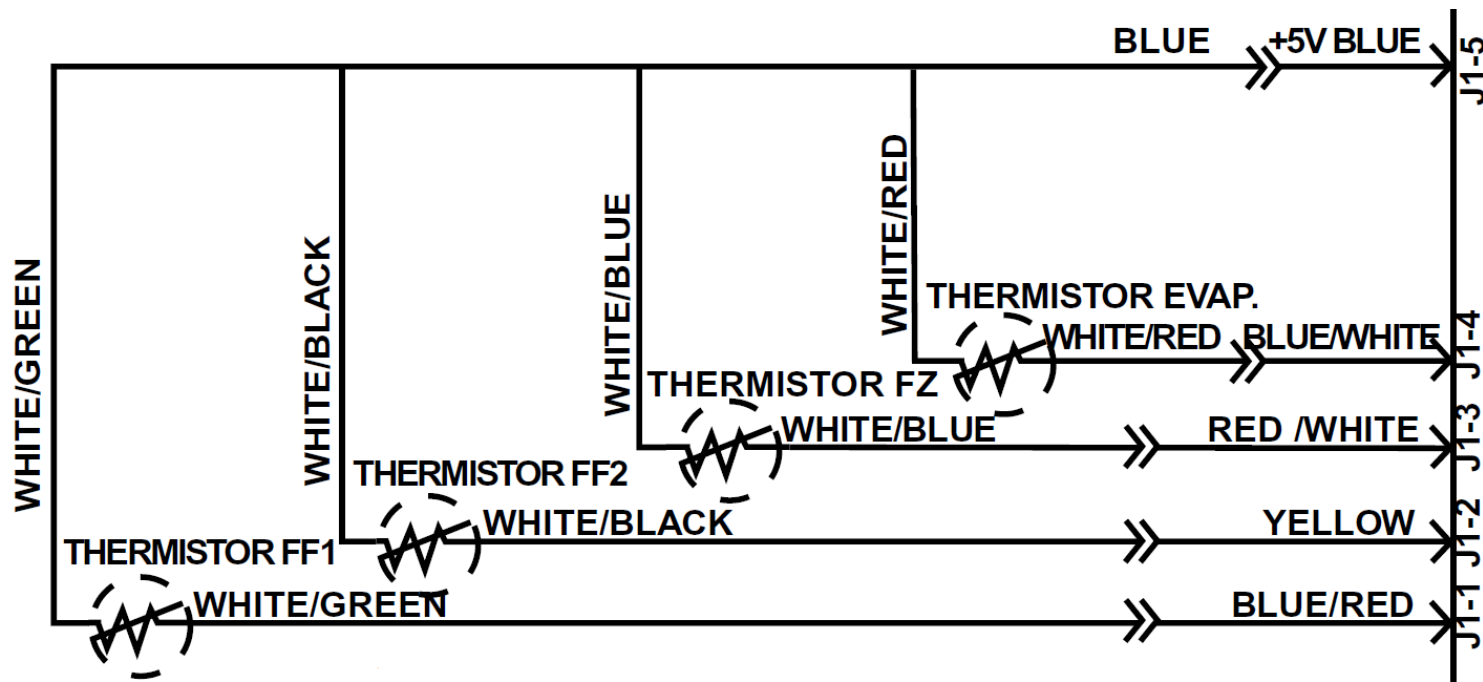

# Thermistor Locations

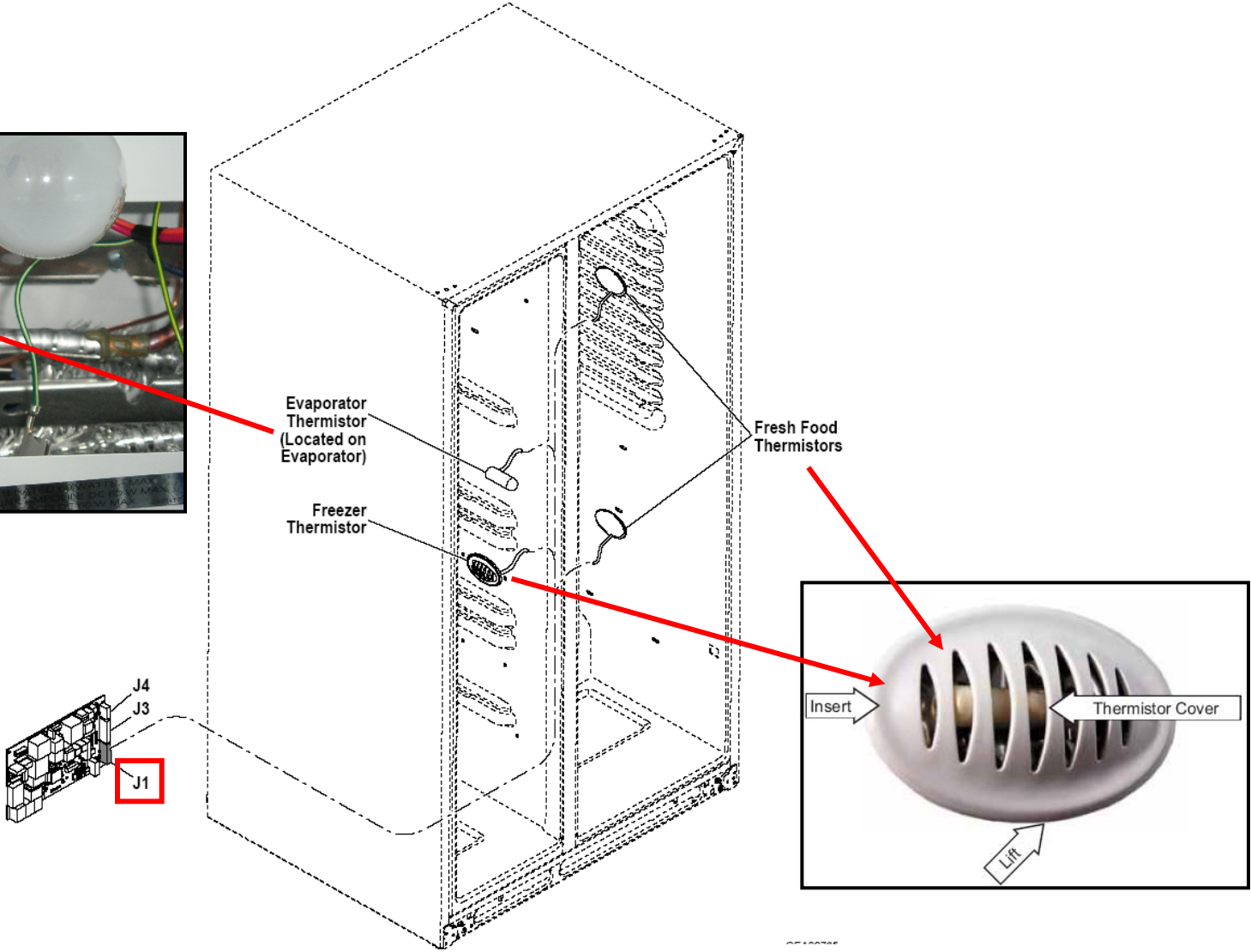
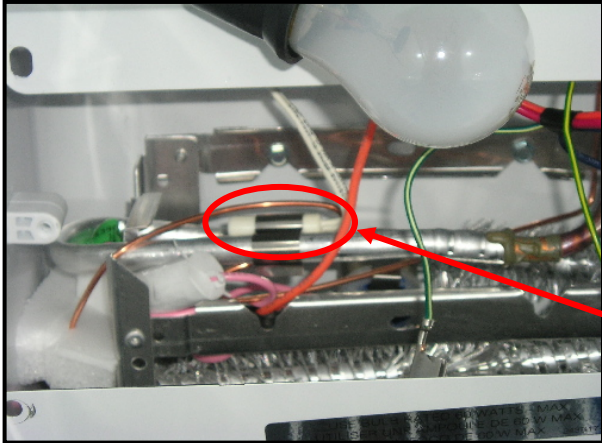

There could be up to 5 Thermistors in a refrigerator, depending on the model.

## Main Electronic Board J1 Connector - Thermistors

The J1 connector provides temperature input from the thermistors to control refrigerator run time and cabinet temperatures. The evaporator thermistor is used only for defrost operation (defrost termination and post dwell.) **J1 pin 5** sends a common 5vdc to all the thermistors and the main board receives the voltage drop back through pins 1 to 4.

To check the 5vdc output from J1-5 read to the J2-3 or J4-3 board common.

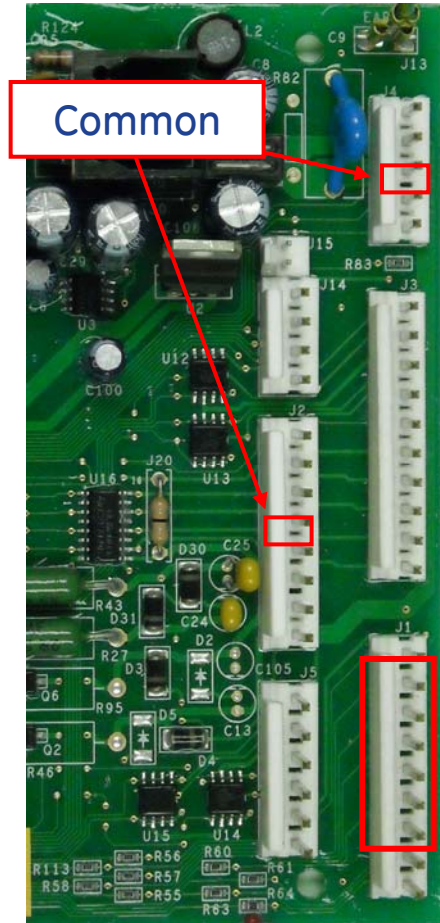
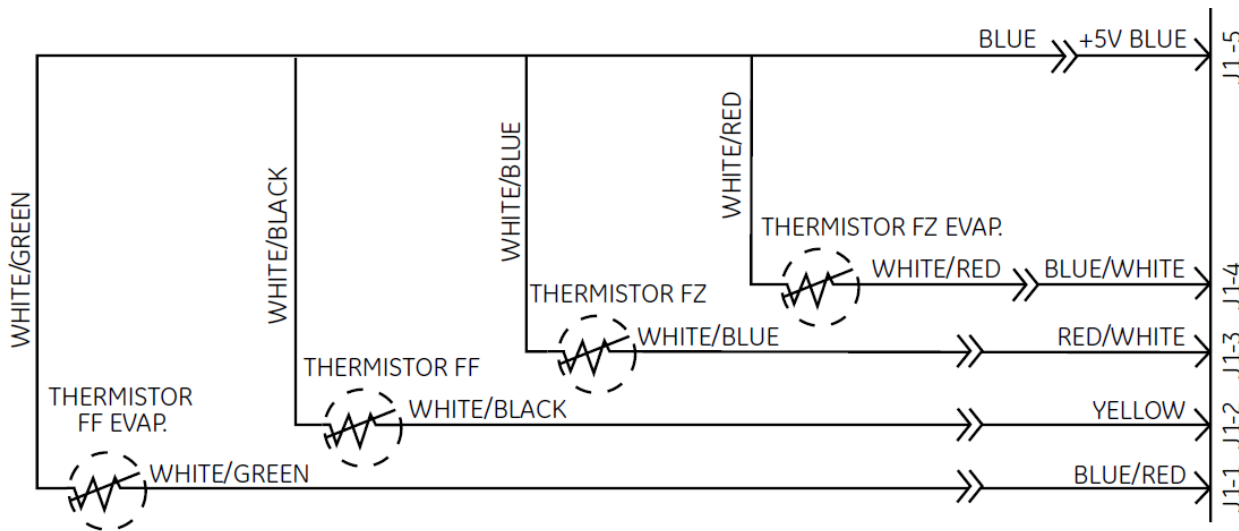

## Main Electronic Board J1 Connector - Thermistors

A quick check of the thermistor operation is to read the voltage drop of the thermistors at the J1 connector. Place one meter probe in J1 pin 5 and check each voltage to J1 pins 1 through 4.

Typical voltage drop is between 1 to 4 dc volts. A thermistor voltage drop of 0vdc indicates a shorted thermistor, 5vdc would indicate an open thermistor. Any voltages below 1vdc or above 4vdc could indicate a suspect thermistor, follow up with a direct test of the thermistor.

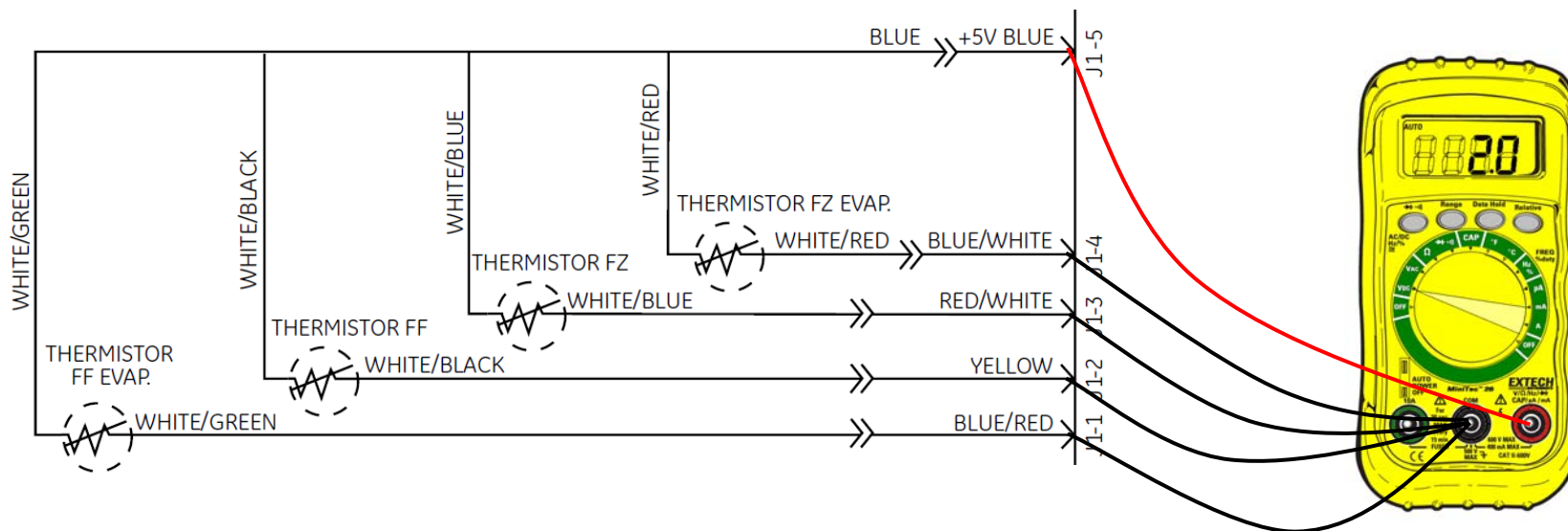

# Thermistor Locations

Some variable speed compressor models utilize the FF2 thermistor input for room temperature.

## Ambient Thermistor

The ambient thermistor is located under the freezer compartment and connected at J1-2 on the main control board. (See **Component Locator Views**.) It assists the main control board in compensating for room ambient that is higher or lower than 60°F.

For example, in ambient below 60°F, the fresh food temperature control will shut down properly. The cooler room ambient assists in keeping fresh food temperatures at the preset temperature. However, the compressor does not get enough run time to bring the freezer down to 0°F.

At lower room temperatures, the ambient thermistor alters the main control board's calculations for the target temperature. The main control board then runs the compressor at higher speeds to get the freezer, as well as the fresh food, to an acceptable temperature.

If the external thermistor is not functioning, the main control board default will assume the ambient temperature is 90°F and there will be no adjustment to the fresh food or freezer set point.

Check the wiring diagram with the unit for specific thermistor usage

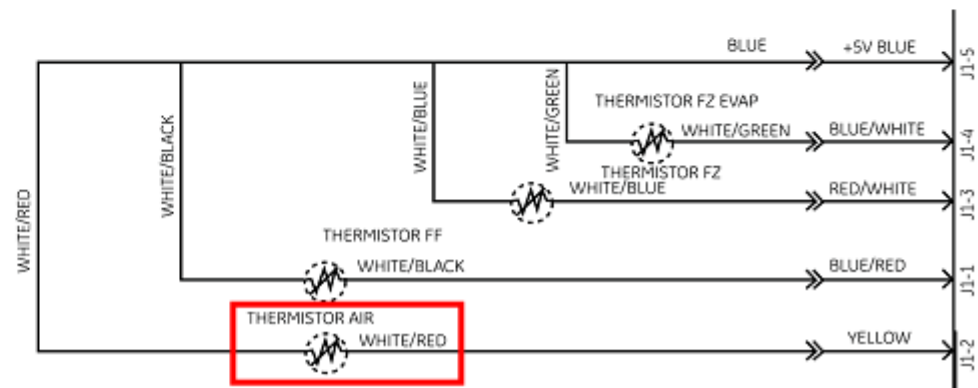

# Testing Thermistors

There are a few ways to test the Thermistors in a refrigerator:

You can test the resistance of a Thermistor by checking the temperature at the thermistor (see the chart below), or you can isolate the Thermistor and use a specific temperature.

To test the resistance of any Thermistor using it's normal temperature (for example the freezer air temperature), first disconnect power to the refrigerator and remove the main board access cover on the back of the refrigerator. Then unplug the J1 connector from the main board, we do this to isolate the Thermistor circuit; so the only value that will be displayed on the meter is for that Thermistor. Use the schematic to find the specific Thermistor you want to check. Place the meter leads into the back of the J1 connector (wire side) at pins 3 and 5 to get the resistance value based on the freezer air temperature.



A complete thermistor/temperature chart can be found on the [customer.net](http://customer.net) support site.

Use keywords thermistor and/or chart in the search.

Thermistor Values		
Temperature Degrees (C)	Temperature Degrees (F)	Resistance in Kilo-ohms
-30	-22	88 kΩ
-20	-4	48.4 kΩ
-10	14	27.6 kΩ
0	32	16.3 kΩ
10	50	10 kΩ
20	68	6.2 kΩ
30	86	4 kΩ
40	104	2.6 kΩ



## Testing Thermistors

Another way to test a Thermistor is to remove the head of the Thermistor from its mounting and insert it into a cup of crushed ice and a small amount of water. The water will cause the ice to be at its melting point of 32°F. Place the meter leads on the J1 connector as previously described.

The Thermistor will read approximately 16KΩ for 32°F.

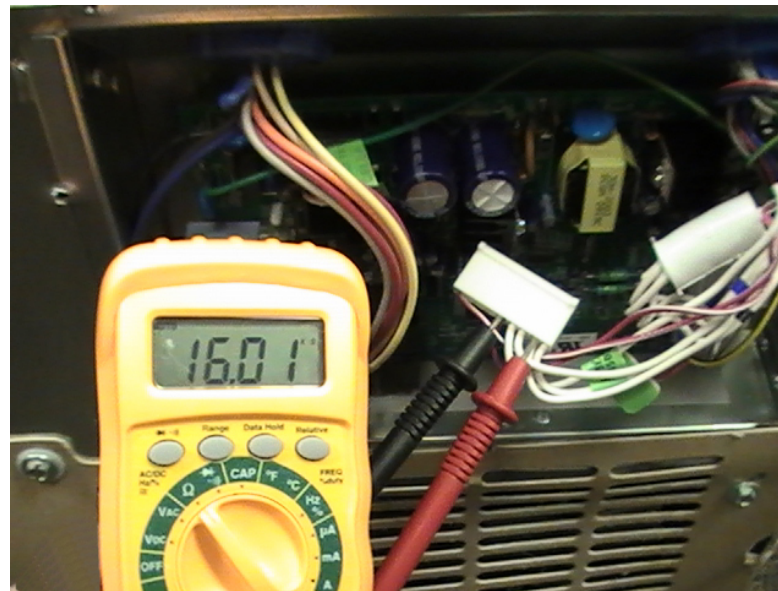

Note: Always test from the wire side of the connector, testing from the board pin side of the connector can cause compression of the pin; creating a poor connection when the connector is installed back on the board.

# Testing Thermistors

You can also test the resistance of a Thermistor by checking the thermistor at room temperature.

At room temperature the thermistor should read around 5 to 6 kohms.

Remember, as temperature decreases the thermistor should increase in resistance.



Thermistor Values		
Temperature Degrees (C)	Temperature Degrees (F)	Resistance in Kilo-ohms
-30	-22	88 kΩ
-20	-4	48.4 kΩ
-10	14	27.6 kΩ
0	32	16.3 kΩ
10	50	10 kΩ
20	68	6.2 kΩ
30	86	4 kΩ
40	104	2.6 kΩ



## Replacement

Should a thermistor require replacement, use plastic bell connectors (part # WR01X10466). Fill each connector with RTV102 silicone, then splice a new thermistor into the harness as shown in the illustration.

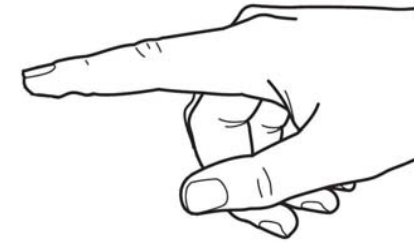
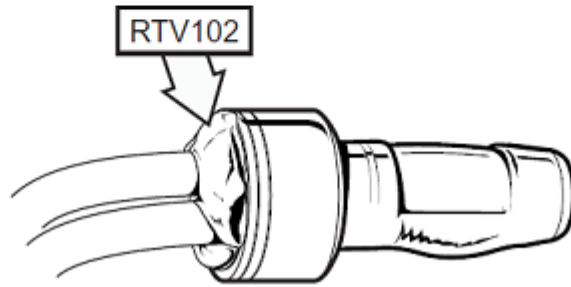

# Sensor Shunt

Many models utilize a foil barrier on the back of the thermistor grille called a “shunt.”

This part is required for proper temperature sensing by the thermistor.

If this part is damaged “torn” or not sticking to the back of the thermistor grille, replace the shunt for proper cabinet temperature control.

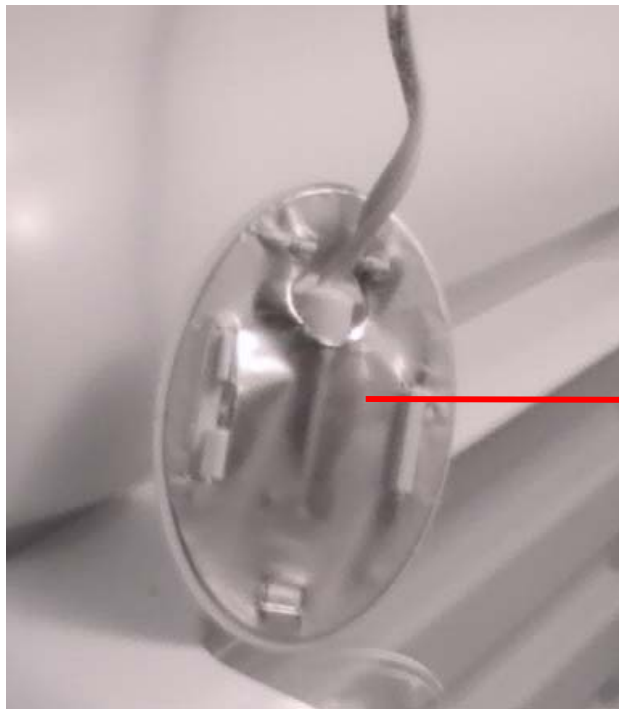

## WR02X10668



## Evaporator thermistor location and drip loop

---

Always reattach the thermistor to its original location to allow for proper temperature sensing.

**Never just leave an evaporator thermistor hanging!**

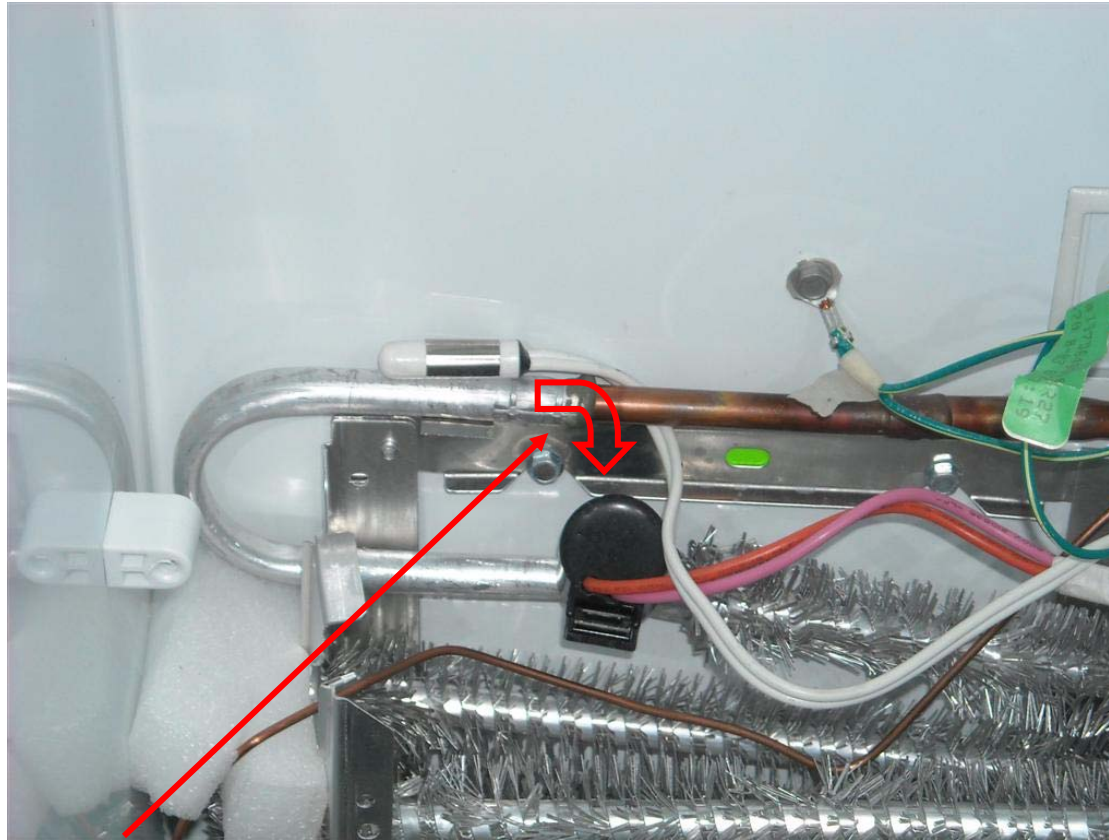

Route the thermistor wiring in a downward angle to create a drip loop. This will minimize the possibility of moisture migrating into the thermistor body over time.

# Defrost problems?

## Check the FZ Evaporator thermistor:

- If it is biased towards a high temperature, it will terminate the defrost cycle before the heater melts the frost. The thermistor is telling the board not to do defrost, so change it and verify that you get a valid temperature.
- If it is biased towards a low temperature, the defrost will run for a long time, and it will time out, and the system will run defrost too often.
- A new installation is set from the factory to defrost the refrigerator after 8 hours of compressor run time.

**Note: On PDS, PFS, GBS and GDS bottom freezer models the evaporator thermistor is mounted to the inlet of the evaporator, check for a short frost pattern if you have cooling or performance issues on these models even though testing shows a low evaporator temperature.**