



THE DCS REFRIGERATOR

SERVICE MANUAL



MODEL:
RF48SS



1 PRECAUTIONS

■ PRECAUTION FOR SAFETY



Warning

- Before operating the appliance, please read this manual thoroughly and retain it for your reference.
- Because these following operating instructions cover various models, the characteristics of your refrigerator may differ slightly from those described in this manual.
- The appliance is not intended for use by children or infirm persons without adult supervision.
- Children should be supervised to ensure that they do not play with the appliance.
- HFC- R134a is used as a refrigerant.

CAUTION/WARNING SYMBOLS USED

	This product operates on rated 240V.
	It indicates that there is possibility of death or serious injury if the instruction is not complied with.
	It indicates that there is possibility of personal injuries or property damage if the instruction is not complied with.

OTHER SYMBOLS USED

	It explains terms to help users to understand how to use the product properly.		It helps users to use the product more efficiently.
	It is a mark indicating that the power plug should be removed from the wall outlet.		It is a mark indicating that it is prohibited to disassemble.
	It is a mark indicating that grounding is required to prevent electric shock.		It is a mark for a reference page.



WARNINGS

Do not plug several appliances into the same multiple receptacle.

- This could cause overheating and the risk of fire.

Make sure that the power plug is not squashed or damaged by the back of the refrigerator .

- A damaged power plug may overheat and cause fire.

Do not bend the power cord excessively or place heavy articles on it .

- This constitutes a fire hazard. If the power cord is damaged, have it replaced immediately by the manufacturer or its service agent.

Do not directly spray water inside or outside the refrigerator.

- There is a risk of fire or electric shock.

Do not spray inflammable gas near the refrigerator.

- There is a risk of explosion or fire.

Do not insert the power plug with wet hands.

- You may receive an electric shock.

Do not put a container filled with water on the refrigerator.

- If spilled, there is a risk of fire or electric shock.

Do not install the refrigerator in a damp place or a place where it may come in contact with water.

- Deteriorated insulation of electrical parts may cause an electric shock or fire.

Do not store volatile or flammable substances in the refrigerator.

- The storage of benzene, thinner, alcohol, ether, LP gas and other such products may cause explosions.



WARNINGS

- Keep ventilation openings in the appliance enclosure or mounting structure clear of obstruction.
- Do not use mechanical devices or any other means to accelerate the defrosting process, other than those recommended by the manufacturer.
- Do not damage the refrigerant circuit.
- Do not use electrical appliances inside the refrigerator/freezer, unless they are of a type recommended by the manufacturer.



WARNINGS

This product has 360° rotating casters.

Take care when moving the fridge on a sloping surface

- The product can tip-over and cause severe injuries.

This product is top heavy. So, there is the possibility of tipping forward when it is not installed correctly. When moving the product, make sure not to tip it over.



CAUTIONS

Do not overfill the refrigerator with food.

- When you opening the door, items may fall out and cause personal injury or material damage.

Do not put bottles or glass containers in the freezer.

- When the contents freeze, the glass may break and cause personal injury.

If the wall socket is loose, do not insert the power plug.

- There is a risk of electric shock or fire.

Do not disconnect the power cord by pulling on it.

- Damage to the cord may cause a short-circuit, fire and/or electric shock.
- If the power cord is damaged, it must be replaced by the manufacturer, a certified service agent or qualified service personnel.

Do not store articles on the top of the appliance.

- When you open or close the door, the articles may fall and cause personal injury and/or material damage.

Do not store pharmaceuticals products, scientific materials or temperature-sensitive products in the refrigerator.

- Products that require strict temperature controls must not be stored in the refrigerator.

Do not let children swing on the door, a serious injury may occur.

If you smell pharmaceutical or smoke, plug immediately and contact your SAMSUNG Electronics service center.

Do not touch the inside walls of the freezer or products stored in the freezer with wet hands.

- This may cause frostbite.

Never put fingers or other objects into the dispenser hole and ice chute. It may cause personal injury or material damage.



CAUTIONS

The refrigerant used in the refrigerator/freezer and the gases in the insulation material require special disposal procedures. Ensure that none of the pipes on the back of the appliance are damaged prior to disposal.

Do not use a wet or damp cloth when cleaning the plug. Remove any foreign matter or dust from the power plug pins.

- Otherwise there is a risk of fire.
- If the refrigerator is disconnected from the power supply, you should wait for at least five minutes before plugging it back.

When there is thunder or lightning or when the product is not used for a long time, flip up the grill panel and set

the power switch to the O (OFF).

- Possibility of electric shock or fire.

Do not store things in the ventilation space.

- It will cause a decrease in cooling performance .

Do not place the equipment directly under the sunlight.

- Never start up an appliance showing any signs of damage. If in doubt, consult your dealer.

■ PRECAUTION FOR SERVICE



CAUTIONS

- The refrigerator only use ice makers which made by SAMSUNG Electronics for the refrigerator.
- The incorporated ice-makers are to be installed only by the manufacturer or its service agent.

Do not disassemble or repair the refrigerator by yourself.

- Fire, malfunctions and/or personal injury may occur.

Do not change the interior halogen lamp by yourself call to service center.

- There is a risk of electric shock

If you wish to dispose of the refrigerator / freezer, remove the doors and seals first.

- Do so in a way, that is not possible for a child to be trapped inside.

Do not insert your hands into the bottom area under the appliance.

- Any sharp edges may cause personal injury.

Turn off the power s/w before changing or fixing of electro-control system.

- There is a risk of electric shock.

Use the genuine parts during changing of electro-control system.

- Check the model name, regular electricity and display of temp etc.



Remove the dust or foreign body from Housing, Assembly and connect during fixing.

- Prevention of fire in case of TRACKING, SHORT
Check for moisture in electro-control system.
- If you find moisture in electro-control system, change the part or clean and insulate.

Check the assembly condition of parts after repairs.



CAUTIONS

Your power socket should have a ground(earth) pin.

- You must ground(earth) the refrigerator to prevent any power leakages or electric shocks caused by current leakage from the refrigerator.

Never use gas pipes, telephone lines or other potential lightening rods as ground.

- Improper use of the ground plug can result in electric shock.

■ PRECAUTION FOR DISPOSAL



CAUTIONS

It must have the following advice.

- Please dispose of the packaging material for this product in an environmentally friendly manner.
- Please contact your local authorities in regard to the environmentally safe disposal of this product.
- This product is intended only for the storage of food in a domestic environment.
- When disposing of a refrigerator, remove the door/ door seals/ door latch so that children or small animals cannot become trapped inside.



PRECAUTIONS BEFORE INSTALLATION

- Select an installation place

Please check the followings before installing the product.

Check if the product can clear the doors on its way to the installation place.

- ▶ If the product is not able to clear the doors, it is not possible to install the product.

Model	A	B	C	D	E	Remark
RF48SS	48"	27.8"	84"	96.8"	88.5"	

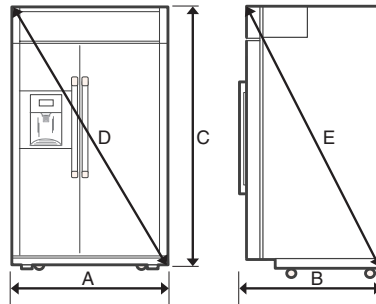

Please check if there is enough space to install the product.

- ▶ If there is not enough space, it is not possible to install the product.

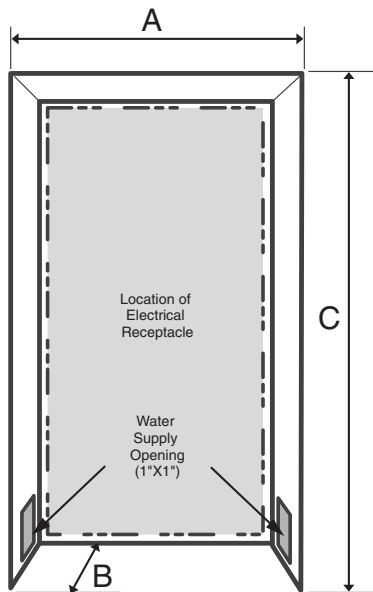

Model	A	B	C	Remark
RF48SS	47.5"	over than 24"	83.5"(Min)	
			84.3"(Max)	



● Select an installation place

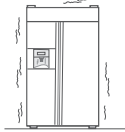

Check if the floor is flat.

- ▶ If the refrigerator is installed on an uneven floor, it will cause vibration and noise.

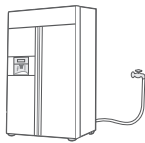

Check if the floor can support the weight of the refrigerator and the food inside (1102lb or 500kg total).

- ▶ It could damage the floor.

Check if the product is placed within the reach of a power point.

If the product is a dispenser model, check that the product is within easy access of water supply and the humidity around the product is low.

- ▶ Please select a place with easy access to water supply for the water & ice dispenser.

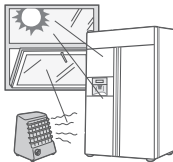

Avoid a place with intense heat or a place that is extremely cold.

- ▶ Install the product with an ambient temperature between 46°F (5°C) and 109°F (43°C).
- ▶ When it is installed at a place with an extremely cold or hot ambient temperature, the products operation can be effected and its cooling capacity will decrease resulting in an increase in power consumption.

● Earth the product

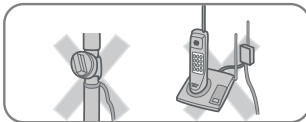

The product must be earthed properly.

Make sure your power outlet has an earth pin.

- ▶ When the product fails to operate properly: Make sure to do earth to prevent electric leakage or an electric shock.
- ▶ When there is no earth with normal products: When touching the handle or surface of the product, a minute amount of electric leakage can be felt. (It can be felt on all products made of electricity conducting materials (metal plate). It is obliged to use a right angle power plug. Also, make sure to earth the product.)

Caution Do not earth it to a gas pipe or a telephone cord. Possibility of explosion, electric shock or fire.

Note

- When the wall outlet is not facilitated with earth There is a risk of electric leakage. At this time, electric leakage can be prevented in some cases when it is plugged in upside down. (But, when it comes to old buildings, the earthed state of the power cord could be unstable even after its cross insertion and it could bring about an electric shock. In this case, the product shall be earthed.)

<When the wall outlet has an earthed terminal>

- ▶ It doesn't need earthing. (But, when the wall outlet has no earthed terminal, make sure to earth the product.)

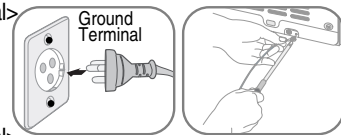

<When the wall outlet has no earthed terminal>

- ▶ When plugging the product into a wall outlet having no earth, connect the earthed wire to the earth-screw on the back of the product and then connect the other end to a metallic water pipe or earth-guide.
- ▶ Never use a wall outlet or an extension cord having no earthed wire. (Without earth, minute electric leakage can be generated.)
- ▶ Please refer to the installation manual for installation details.



2 Product Specifications

● Product Specifications

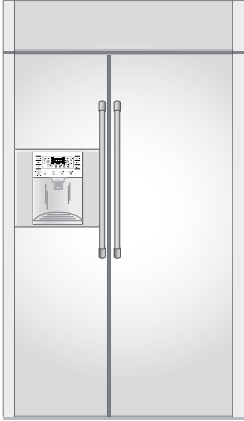
Model Name		RF48SS
		DISPENSER
		
GROSS volume	Tot al	766
	Freezer Room	279
	Fridge Room	487
Storage volume	Tot al	705
	Freezer Room	255
	Fridge Room	450
Dimension	Width(mm)	48"
	Height(mm)	84"
	Depth(mm)	27.8"
Weight		574lb
Rated V/Hz		AC 115V / 60Hz
Motor Power Consumption		155kw
Heater Power Consumption		500W
Refrigerator Type		Indirect Cooling
Refrigerant		HFC-134a
Refrigerant Quantity		0.5lb
Freezer Performance		4 STAR
Power Consumption		730 kw/Y
Star Rate Index		DOE meet



Product Specifications

Model Name			RF48SS	
Cooling Components	Compressor	Model Name	BK190CL2X/EO2	
		Starting Type	Inverter	
		Oil Charge	Freol α-15 (Ester)	
	Evaporator	Refrigerator	Split Fin Type	
		Freezer	Fin Cross Type	
	Step Motor Valve		DC14V/ Unipolar 1-2 Phase Excitation Method	
	Condenser		Forced or Natural Convection	
	Dryer		Molecular Sieve XH-9	
	Capillary Tube	Freezer	ID0.85 X L3300 4.4 Kg/cm ²	
		Refrigerator	ID0.85 X L3000 4.2 Kg/cm ²	
Refrigerator → Freezer		ID3.36 X L1000		
Refrigerant		HFC-134a		
Room Temp Sensor	Freezer	Model Name	Temp Selection	ON(°F)
		Thermistor	MAX	-14°F
		(F-Sensor)	MID	0°F
		PX-41C	MIN	8°F
	Refrigerator	Model Name	Temp Selection	ON(°F)
		Thermistor	MAX	34°F
		(F-Sensor)	MID	38°F
		PX-41C	MIN	46°F
	Fresh	Model Name	Temp Selection	ON(°F)
		Thermistor	Soft Freeze	23°F
		(F-Sensor)	Fresh	30°F
		PX-41C	Cool	38°F
Defrost Related Components	Initial Defrost Cycle (F+R Defrost)		4 Hr ± 10 Min	
	F-Defrost Cycle		10~20Hr (Vary according to the using conditions)	
	R-Defrost Cycle		5~10Hr (Vary according to the using conditions)	
	Idling Time		10 ± 2M in	
	F-Defrost Sensor	Model Name	Thermistor (PX-41C)	
		SPEC	5.0K Ω at 77°F	
	R-Defrost Sensor	Model Name	Thermistor (PX-41C)	
		SPEC	5.0K Ω at 77°F	
	Bimetal		Rated	AC 125V 10A
			On/Off	OFF
Operating Temp			140 ± 41°F	



Model Name			RF48SS
H e a t e r	F- Defrost Heater	On upon F-Defrost	AC 115V 300W(Sheath heater)
	F- Drain Heater		AC 115V 35W(Cord Heater)
	F - SUB Drain Heater		AC 115V 10W(Cord Heater)
	R- Defrost Heater	On upon R-Defrost	AC 115V 110W(Heater Pipe)
	R -Drain Heater		AC 115V 30W(Cord Heater)
Dispenser Heater			AC 115V 7W (Cordheater)
Water Supply Heater			AC 115V 5W (Cordheater)
F-Defrost Heater Overheat Protection Bimetal			AC 125V 10A / AC 250V 5A
R-Defrost Heater Overheat Protection Bimetal			
Noise Filter			AC 250V 10A 50/60 HZ
O v e r l o a d P r o t e c t o r	Model Name		4TM445 PHBYY-82
	On Temp		156°F ± 48°F (69 ± 9°C)
	Off Temp		257°F ± 41°F (125 ± 5°C)
F-Room Cooling Fan Motor			DC12V DREP3030LB / φ67, L237.4, Blower Fan
R-Room Cooling Fan Motor			DC12V DREP3030LB / φ67, L295.5, Blower Fan
Comp Cooling Fan Motor			DC12V DRCP3030LA / φ 170, Shroud Fan
Fresh Island Fan Motor			DC12V G8015S12B-SS / 1800 RPM
Fresh Island DAMPER			DC12V NSBY001TB1 / Unipolar 1-2 Phase Excitation Method
Ice Maker Geared Motor			AC 120V / MVCC18AR19 / 0.3 RPM, 4.5W, 8 POLE
Dispenser Geared Motor			AC 120V / MVCC18AR19 / 18 RPM, 3.5W, 8 POLE
Ice Maker Auger Motor			110~12V, 60Hz/ISG3240SSI/18RPM,102W
Ice Maker			DC 12V NTGN001TA1 / 160 DEG
Dispenser Micro S/W			0.6A / -125VDC / 0.3A-250VDC
F-Room Lamp			Halogen Lamp AC 12V, 35W X 2EA, Reflector 2EA
R-Room Lamp			Halogen Lamp AC12V, 35W X 2EA, Standard30w 1EA
Dispenser Lamp			Incandescent Lamp AC 120V, 15W, Blue color
Convertible			High Brightness LED ※ 5EA
Door S/W			AC 125~250V, 11A
Power Cord			AC 125V 15A, AWG #
Earth Screw			BSBN (Brass Screw)
Trans			AC 250V X 2EA
Main S/W			AC 250V 15A
Water tank Heater			AC 115V 5W



● Product Dimension

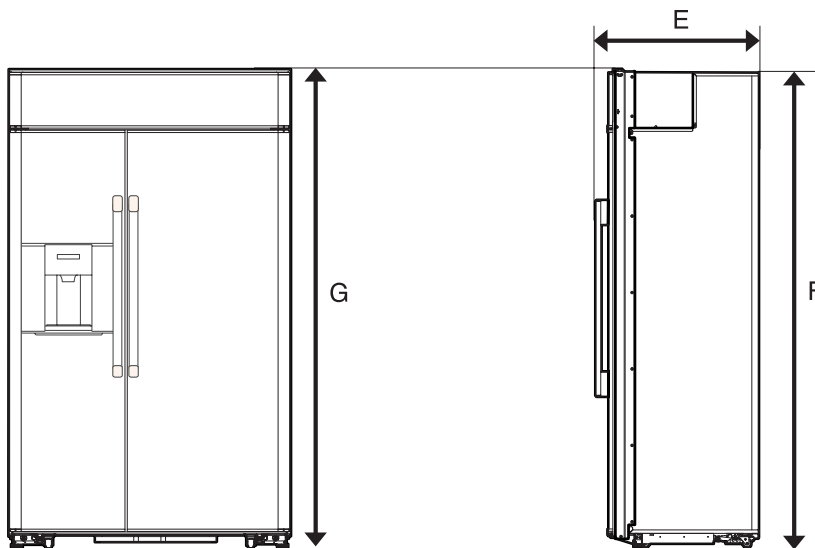
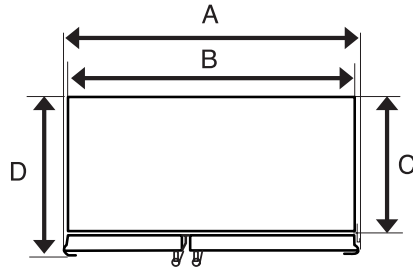

DOOR 90° OPEN

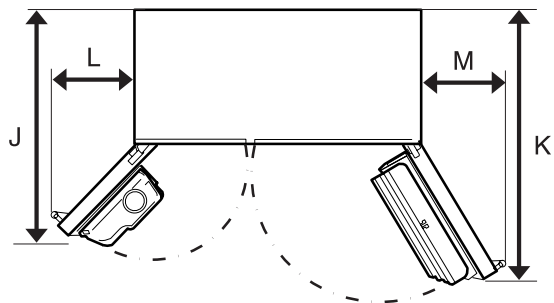
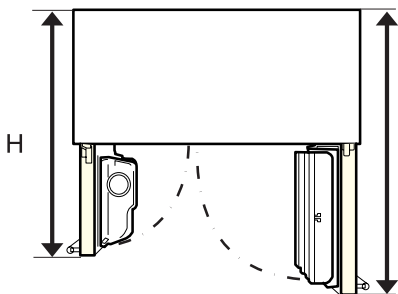

MODEL	A	B	C	D	E	F	G	H	I	J	K	L	M
RF48SS	48"	47"	24.8"	25.6"	27.8"	83.4"min 84.2"max	84"min 84.8"max	44"	52"	40.8"	42.9"	13.6"	20.3"



PART	PART NAME	CODE	REMARKS
	ANTI-TIP BRACKET	DA61-01589A	
	Cap support filter	DA99-00466A	
	Filter	DA29-00003B	
	Water line	DA97-00753A	
	Tapping Screw	6002-000213	
	Clip A	DA65-20110B	
	Sealing Tape	0203-000399	



● Refrigeration Cycle

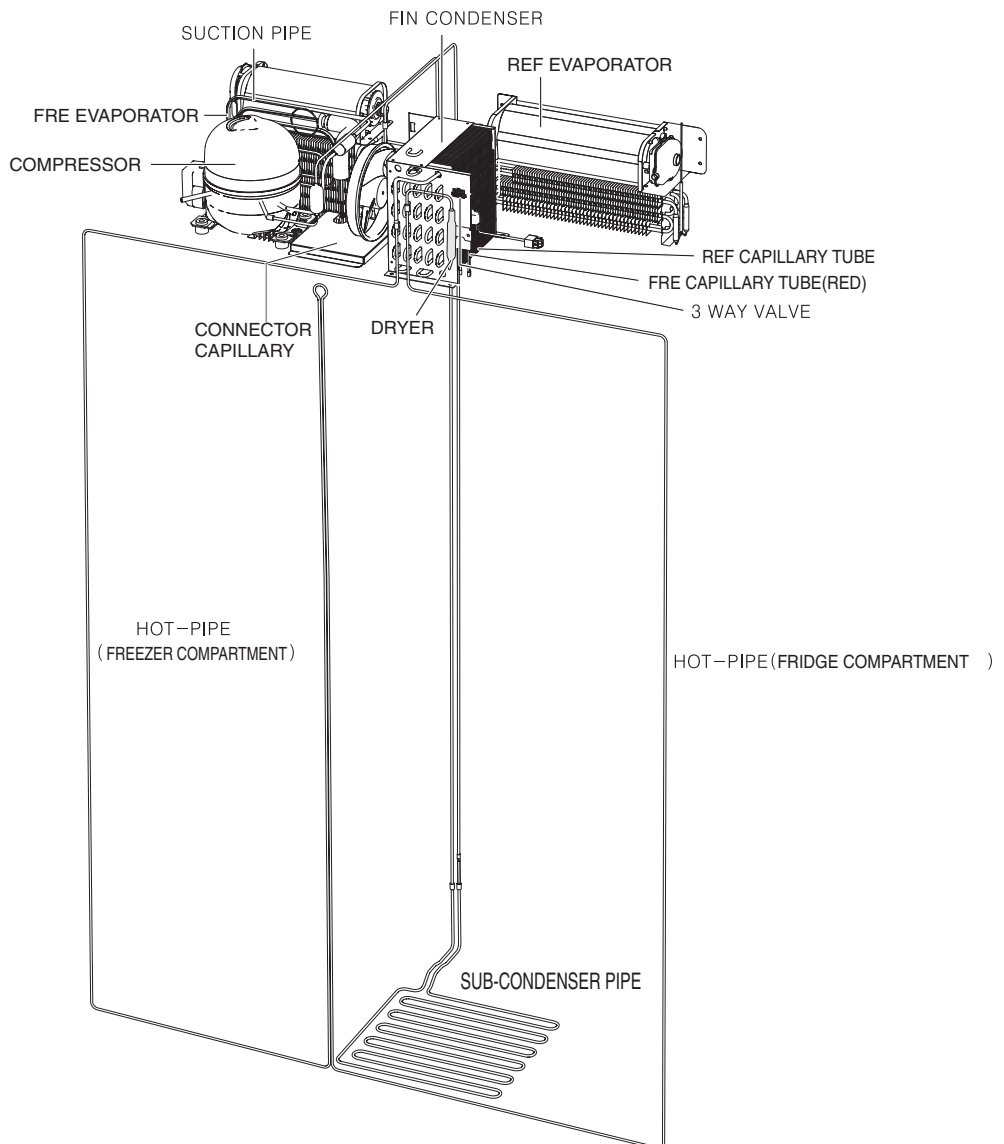
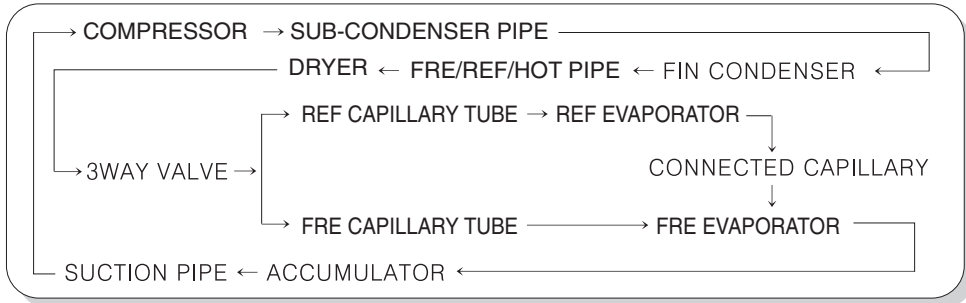



● Cold Air Circulation

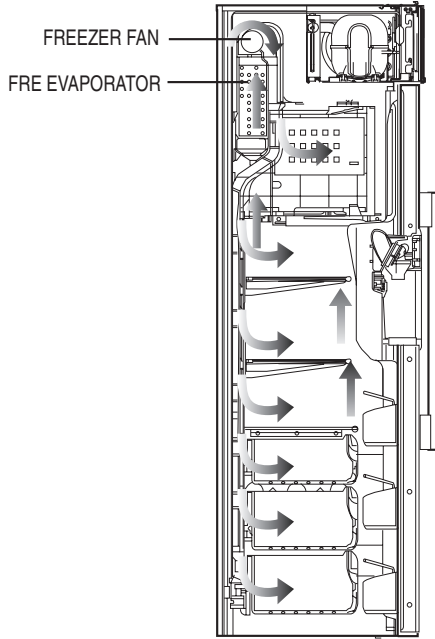

FREEZER COMPARTMENT

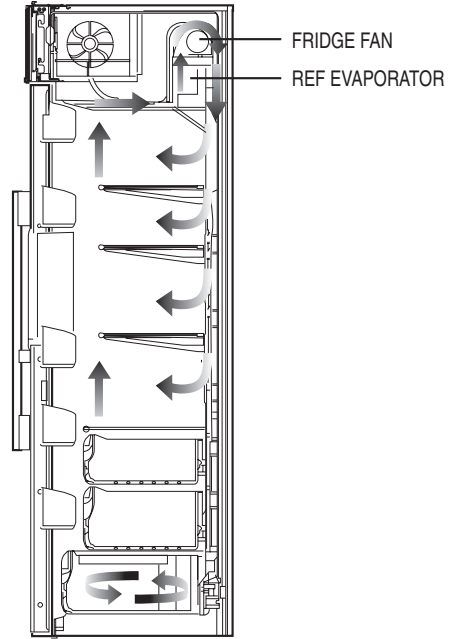

FRIDGE COMPARTMENT

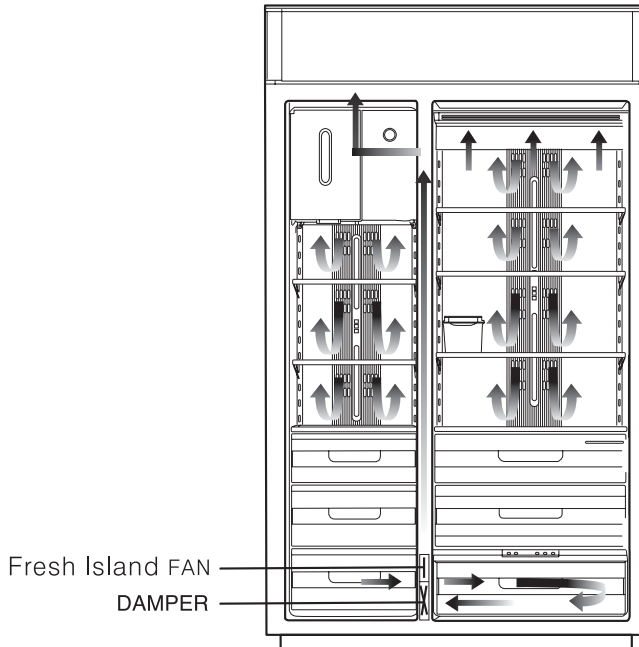

FRONT VIEW



2-1 REFRIGERATION CYCLE

● BASIC REFRIGERATION CYCLE

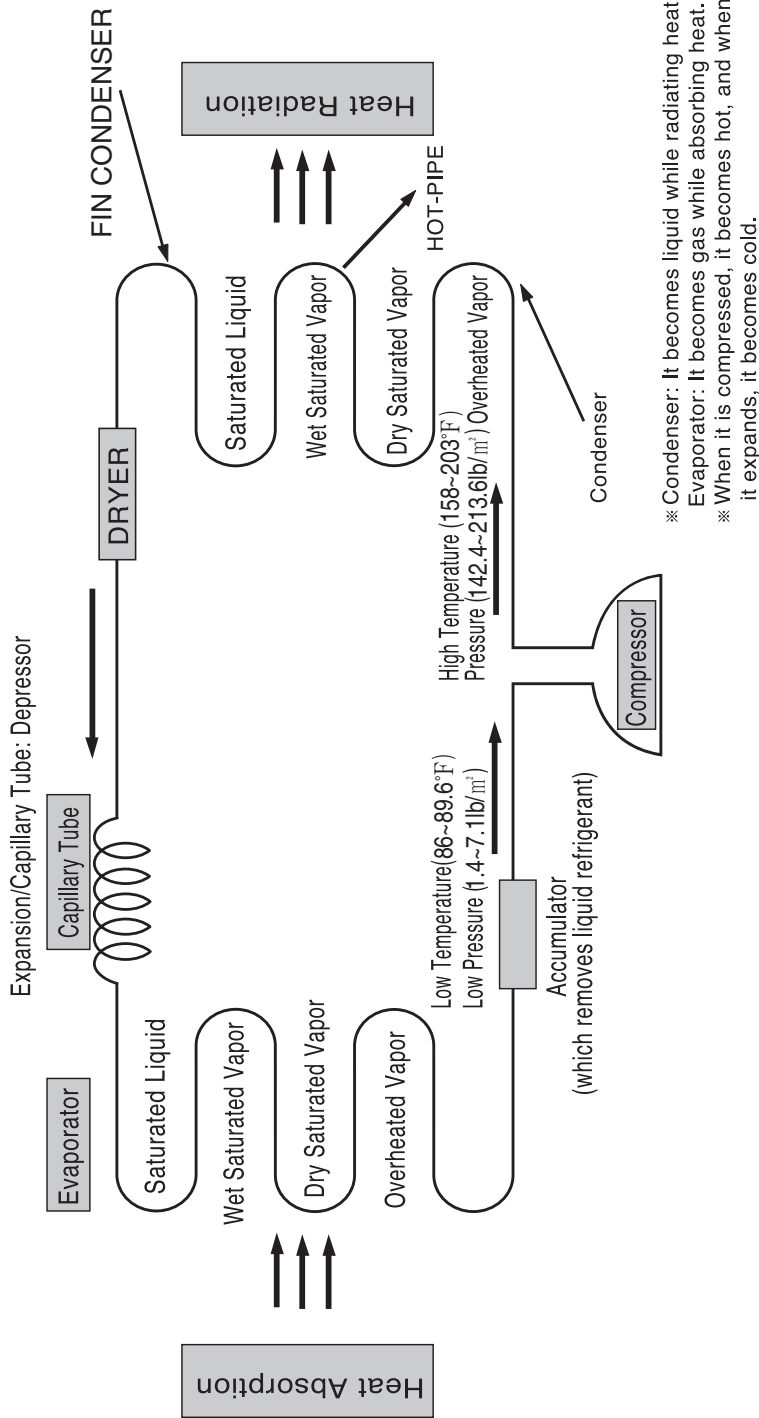

- * Components of the Cycle: Compressor, condenser, capillary tube and evaporator (cooler)
- 4 Steps of the Refrigeration Cycle: Compression → Condensation → Expansion → Evaporation
- * Flowchart Liquid refrigerant evaporates in the evaporator and becomes low pressure, low temp. → Absorb heat from the refrigerator → The compressor absorbs the gas refrigerant → Send the high temp & pressure gas to the condenser → The condenser transfers the heat from the compartments and the heat generated during the compression cycle, and becomes liquid. → It reduces its pressure in the capillary tube. → It goes into the evaporator, repeating the above cycle.



22 Actual Refrigerant Pipe

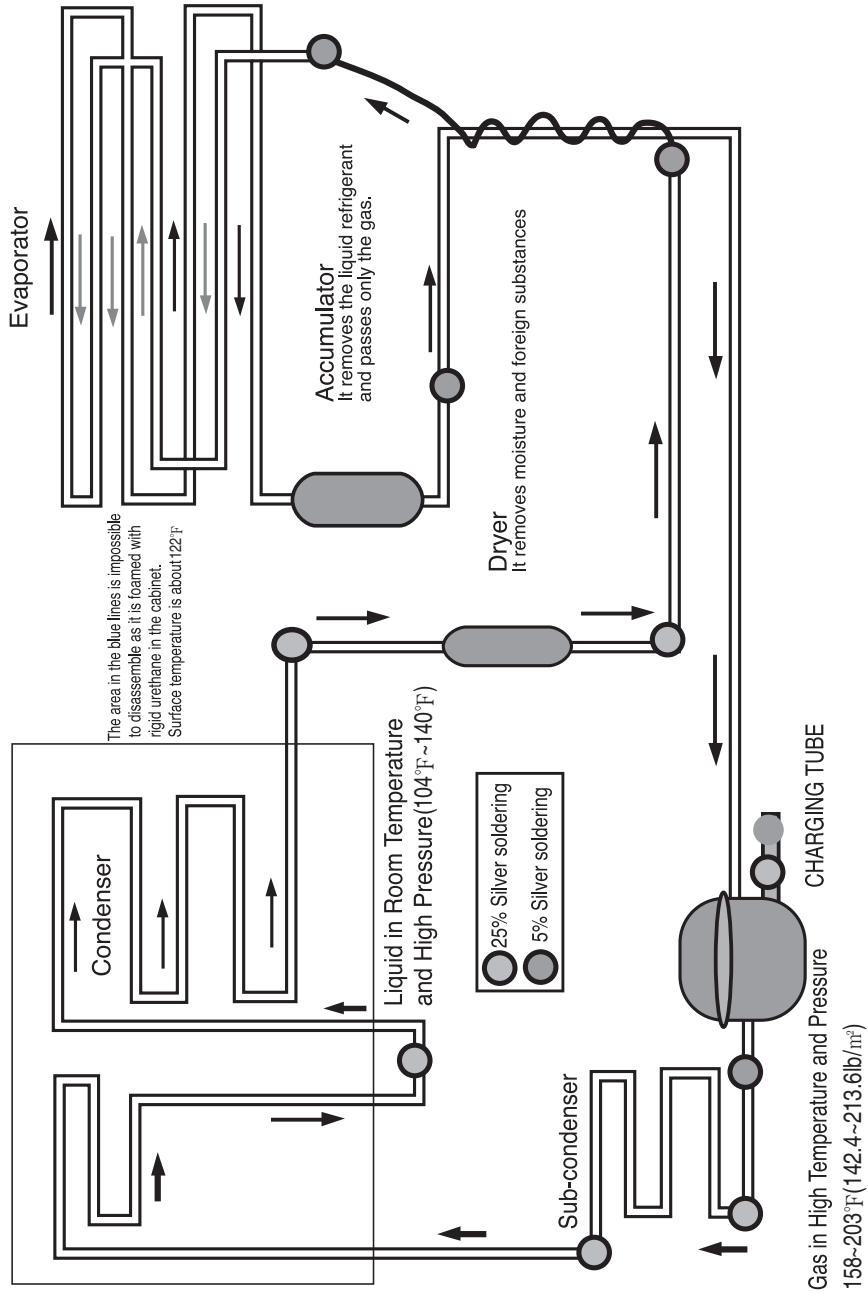



1. Principles of the Cold Cycle

1) Compressed Stroke (Adiabatic Compression)

Low temperature and pressure gas absorbed from the evaporator is compressed rapidly by the piston, the work applied to the gas will be changed into heat and the gas becomes high temperature and pressure. (It is considered as adiabatic compression as the heat doesn't come in or go out in this process.)

2) Condensed Stroke (Isothermal Compression)

High temperature and pressure gas is discharged from the compressor, gets cooled after it enters the condenser. As it emits the residual heat through the condensation until it changes to a liquid state, the temperature doesn't change. Only its state changes. This state is the isothermal compression. This state is called super-cooling the temperature of the gas which is completely liquefied at the end of the condenser drops.

3) Pressure Reducing Stroke (Adiabatic Expansion)

When the liquefied gas in room temperature and high pressure goes through rapid throttling action in the capillary tube, it expands quickly and goes into the evaporator. At this time, its temperature drops, and it is due to its adiabatic expansion, not to take heat away from its surrounding during its throttling action.

4) Evaporating Stroke (Isothermal Expansion)

The gas that came into the evaporator has already get cooled, but its liquefied part keeps evaporating until it gets completely vaporized and takes the residual heat of evaporation away from the surrounding.

2. Roles of the Cold Cycle Components

Compressor: It compresses gas in low temperature and pressure into that of high temperature and pressure and circulates the gas in the cycle.

Condenser: It condenses gas refrigerant in high temperature and pressure into liquid refrigerant in room temperature and high pressure.

Capillary Tube: It decompresses liquid refrigerant in room temperature and high pressure, and expands it into low temperature and pressure.

Evaporator: The liquid refrigerant in low temperature and pressure takes heat away from its surrounding, and changes into gas in low temperature and pressure.

■ Throttling Action

When gas passes the area whose resistance is high, the pressure drops to its flowing direction due to the friction or dispersion of its flow. In other words, the pressure drop at the narrow area is said to be throttling. The extent of the pressure drop depends on the properties, states and speed of gas and on the sizes of the capillary whose passage gets narrow.

3. How the Refrigeration Cycle Components Work

■ Condenser

1) Roles: It emits heat to the outside (water/air) to change gas refrigerant in high temperature and pressure, which is discharged from the compressor, into liquid.

2) Types

A. Air Cooling Type: It condenses air by circulating it naturally or compulsorily.

① Natural Convection Type: It uses a home refrigerator whose condensing capacity is small.

② Forced Convection Type: It circulates air using a fan-motor forcibly (large capacity).

B. Hydro-Cooling Type: It passes water coolants into the pipes of the condenser (large capacity).



※ Location:

- ① Cluster Radiating Type: It releases heat through the pipes in the front right and left inside of the refrigerator to release heat to all over the cabinet, which is good for heat radiation and foamed with rigid urethane,
- ② It is installed outside of the refrigerant (old-type).
- ③ It is gathered in the lower side of the refrigerant, and its heat is radiated forcibly by using the fan.

☞ It releases the residual heat of condensation until it is completely liquefied, and makes the gas change only its state without changing its temperature.

◆ References ◆

※ Thickness of the Pipe

- ① Low Pressure: 0.25" ② High Pressure: 0.19" ③ Capillary Tube: 0.016~0.03" or so

※ Length of the Condenser (300L for a Standard): 86.9'

- ① AUXILIARY: 16.4' ② HOT – PIPE: 21.6' ③ CLUSTER – PIPE: 49.2'

■ Capillary Tube

1. Roles: It decompresses the liquid refrigerant of room temperature and high pressure to make the refrigerant of low temperature and pressure and supplies it to the evaporator.
 - 1) It vaporizes the liquid more at low temperature during its evaporation.
 - 2) Though the compressor stops working, the refrigerant does not flow backward to the condenser but it flows into the evaporator. This makes small the pressure difference between the high pressure side and the low pressure side, and it makes it easy to operate the compressor again.
2. Overview
 - 1) Diameter: 0.016"~0.03 or so
 - 2) Length: It is possible to bring it into low temperature and pressure (50°F, 71.2lb/m³) according to the resistance of 6.56' long and thin wall of the copper pipe.

■ Evaporator

1. Roles: It makes food frozen when the low pressure liquid refrigerant from the capillary tube changes into the low pressure gas refrigerant by absorbing the compartment's heat.
2. Principle: The liquid refrigerant of low temperature, which flows in from the evaporator, keeps evaporating until it is completely gasified, and takes the residual heat of evaporation away from the surrounding.

3. Types

- 1) Roll – Bond Condenser °ÊDirect Cooling One-Door Type

☞ It rolls and bonds two sheets of aluminum to make a passage for refrigerants.

- 2) Pin – Pipe Type °ÊIndirect Cooling Two-Door Type

☞ It attaches small-size aluminum sheets on aluminum pipe to achieve good cooling effect.

■ Compressor

1. Roles: It plays the same role as a pump which draws underwater from the earth. It takes in the gas refrigerant with low temperature and pressure from the evaporator to change it into the liquid refrigerant with high temperature and pressure in the compressor before being sent to the condenser.



2. Types

A. Reciprocal Movement Type: It compresses by shifting the motor rotation to the reciprocal movement of the piston with the shaft and the cylinder.

※ It is used for home refrigerators.

B. Rotary Type: It inhales and compresses the refrigerants in the air gap between the rotator and the cylinder attached in an eccentric way to the rotary axis.

C. Centrifugal Type

■ Drier

1. Roles: It absorbs moisture and removes foreign substance from the refrigerant during the circulation of the refrigeration cycle.

2. Structure: A small amount of moisture can cause the small entrance of the capillary tube to get frozen, which makes it impossible for the refrigerant to circulate. So silica gel or molecular sieve (drying agent) is sealed to absorb the moisture inside it, and a fine net is installed to remove foreign substance at its both ends.



Molecular Sieve

Metal Filter

※ Effect of Moisture

- ① Moisture deposition – Clogged by ice
- ② Responding with coolant
- ③ Life time shortening of oil
- ④ Acceleration of oxidation
- ⑤ Copper coating effect
- ⑥ Gas decomposition through interaction of composite insulators

※ Foreign Substances' Effect

- ① Condensed temperature increases
- ② Vortex temperature increases
- ③ Efficiency of refrigeration decreases
- ④ Its life time shortens due to frictions between oil and foreign substances inside the compressor.



■ Accumulator

1. Roles: It removes the liquid refrigerant from the evaporator completely to send only the pure gas refrigerant to the compressor.

※ A liquid refrigerant to the compressor can cause its overload.

2. Structure:

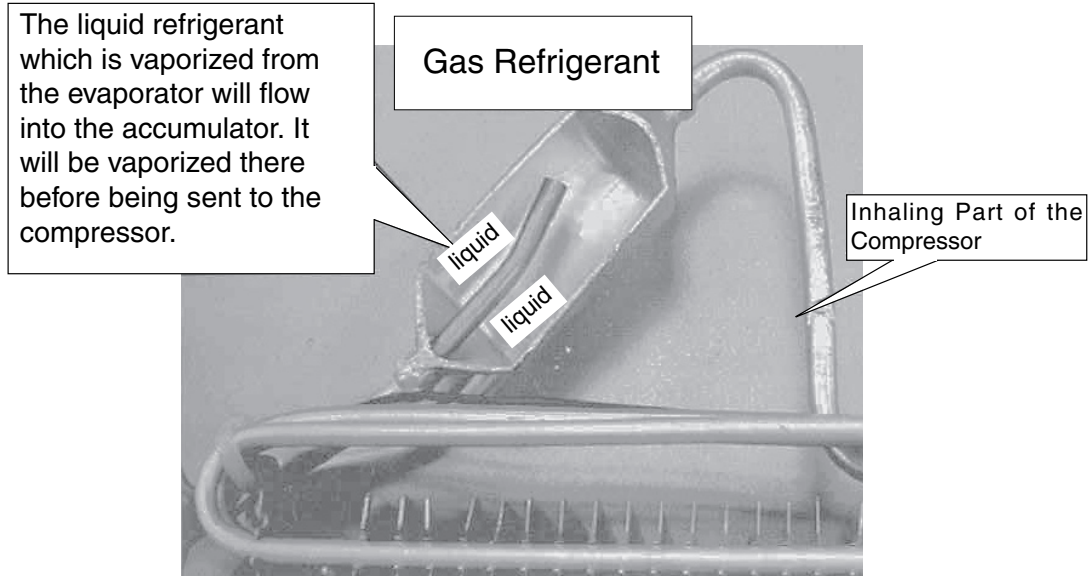



3 PRODUCT FUNCTION



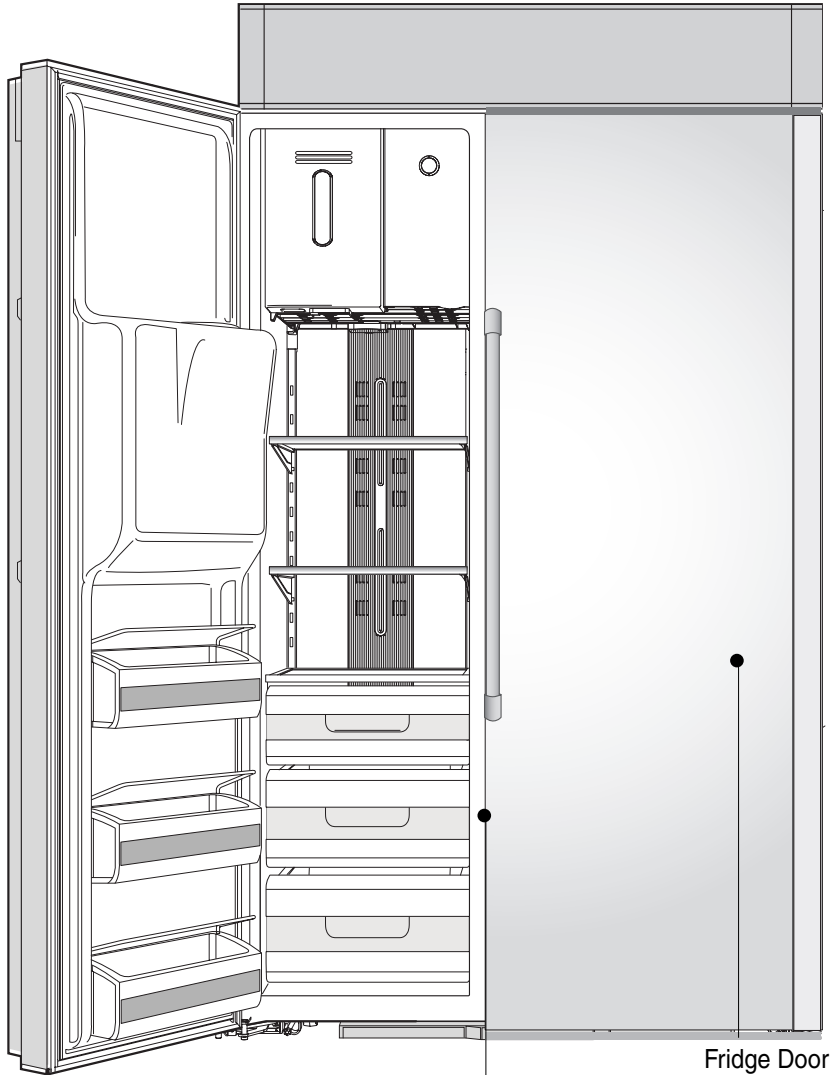

Door Handle

Fridge Door



● HOW TO STORE FOOD

Ice Bin

It stores ice cubes made by the ice maker. Do not store other food except ice cubes.

Winter Closet

You can store frozen pizzas

Freezer Compartment Shelf

You can store various kinds of frozen food such as meat, fish and ice creams.

Freezer Door Bin

You can store small packaged frozen food such as beans. But, do not store ice creams or food for long time storage.

Dried Food & Meat Keeper.

For the purpose of storing for a long time meat and chicken after wrapping with aluminum foil or plastic wrap.

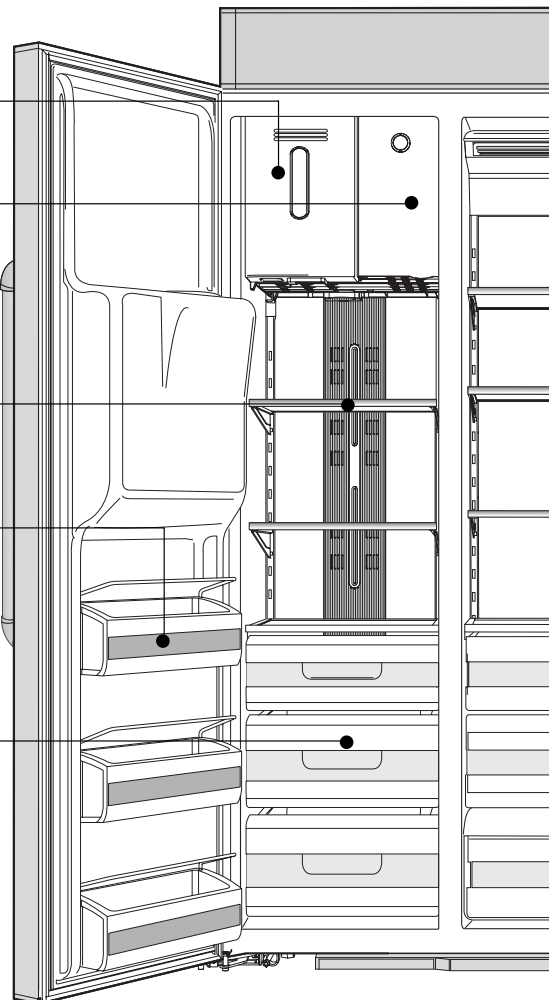

■ Tips on food storage



Store fruits after washing water.

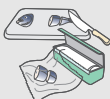

Divide storing food into small sizes and store them.

▶ Power can be saved because food can be cooled-down quickly.

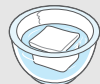

Put food with higher water contents on the front part of the fridge shelf.

▶ When you put it on the inner part of the fridge shelf directly exposed to the cold air, it could become frozen.



Make sure to store food containers with lids or plastic wrap on them..



Do not store hot food, store it after cooling down.

▶ If you cool it down before putting in the refrigerator, the product can perform efficiently and power can be saved.

▶ When hot food is put in the refrigerator, it could cause water condensation or frost inside.



Please store foods with enough space between items.

▶ When excessive amount of food is stored, it could interrupt air circulation resulting in a decreased cooling capability.



Dairy Bin

You can store dairy products such as butter and cheese.

Fridge Compartment Shelf

Please put dishes or refrigerated foods with enough space between items.

Fridge Door Bin

You can store small packaged refrigerated food and beverages such as milk, fruit juice and beer.

Veggie/Fruit Drawer

You can store vegetables and fruits in fresh conditions.

Fresh Island

You can store meat, raw fish and food which needs to be stored at lower temperature than that in the fridge compartment to be used within a week.



Caution

- Do not touch on containers or food in the freezer compartment with wet hands. Possibility of frostbite.
- Do not put food or containers in a place directly exposed to the cold air discharging port. It could be colder than the set temperature resulting in food damage.
- Do not keep medical products or lab materials in the refrigerator. This product is only for food storage.
- Do not put any glass bottles, in the freezer compartment. When the content freeze, it can burst, and causing severe injury.



● HOW TO CONTROL TEMP

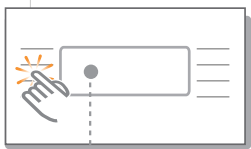
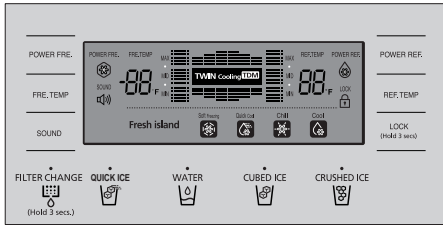

■ How to control freezer temperature

To control the freezer temperature, follow the procedures below.

Press the [FRE. TEMP] button.

- ▶ Freezer temperatures can be adjusted between -8°F and 14°F with an interval of 2°F. At this time, the temperature indication bars will be illuminating, showing the temperature range (MAX, MID or MIN).

When the freezer temperature is set, it will display the set temperature for the first 5 seconds. And then, it will display its current temperature.

- ▶ When the set temperature and the displayed temperature are different from each other, it will be automatically adjusted to the set temperature.
- ▶ The numbers on the display represent the inside temperature of the freezer compartment.



- The freezer temperature could change depends on the number of door opening times, the quantity of stored food and the ambient temperature.
- Each storage section in the freezer compartment may have a different temperature.
- When the temperature in the freezer compartment has increased due to frequent use or the storage of hot food, the temperature display will blink. (In this case, when the temperature reaches the set temperature, it will stop blinking. But, if it keeps on blinking, please contact our service center.)

■ To speed up ice production

Press the [POWER FRE.] button.

- ▶ POWER FRE will illuminate in the display and it will start operating.

Press the [POWER FRE.] button one more time to cancel the POWER FRE function.

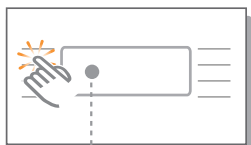

- The POWER FRE function will be automatically turned off after a certain period of time and the freezer temperature will return to the temperature set right before the POWER FRE function is selected.
- When you press the [POWER FRE.] button, the refrigerator will continuously operate for a certain period of time.



■ How to control fridge temperature

To control the fridge temperature, follow the procedures below

Press the [REF. TEMP] button.

- ▶ fridge temperatures can be adjusted between 34°F and 46°F with an interval of 2°F.

At this time, the temperature indication bars will be illuminating, showing the temperature range (MAX, MID or MIN).

When the fridge temperature is set, it will display the set temperature for the first 5 seconds. And then, it will display its current temperature.

- ▶ When the set temperature and the displayed temperature are different from each other, it will be automatically adjusted to the set temperature.
- ▶ The numbers on the display represent the inside temperature of the fridge compartment.

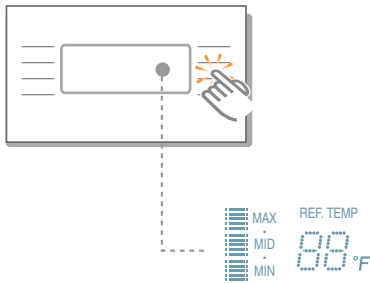

Note

- The fridge temperature could change depends on the number of door opening times, the quantity of stored food and the ambient temperature.
- Each storage section in the fridge compartment may have a different temperature.
- When the temperature in the fridge compartment has increased due to frequent use or the storage of hot food, the temperature display will blink. (In this case, when the temperature reaches the set temperature, it will stop blinking. But, if it keeps on blinking, please contact our service center.)

■ To cool down the fridge compartment faster

Press the [POWER REF.] button.

- ▶ POWER REF will illuminate in the display and it will start operating.

Press the [POWER REF.] button one more time to cancel the POWER REF function.

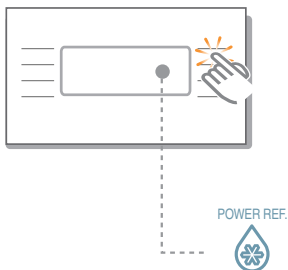

Note

- The POWER REF function will be automatically turned off after a certain period of time and the fresh food temperature will return to the temperature set right before the POWER REF function is selected.
- When you press the [POWER REF.] button, the refrigerator will continuously operate for a certain period of time.



● Fresh Island



■ Function selection

1 When SUB FREEZE is selected

- ▶ When SUB FREEZE is selected, the temperature of the Fresh Island will be set to 23°F and the temperature of the fridge compartment will be maintained at 23°F regardless of its temperature setting.
- ▶ The temperature (23°F) of SUB FREEZE falls into the subfreezing temperature range. Water in meat or fish will not freeze hard it will freeze soft enough that it can be cut easily.

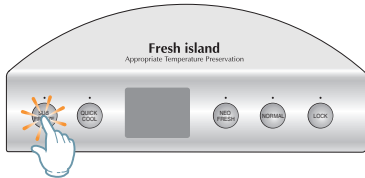

2 When QUICK COOL is selected

- ▶ With this QUICK COOL function, you can cool down up to three bottles of room temperature beer enough to drink within an hour.
- ▶ You can put food in the Fresh Island and press the QUICK COOL button, the refrigerator will operate for an hour continuously.
- ▶ If you use QUICK COOL, take out the food from the Fresh Island and put it in the fridge compartment during its operation. The food could become frozen with the strong air flow.
- ▶ To cancel the QUICK COOL function, press the QUICK COOL button once more. When the QUICK COOL function is completed, it goes back to the previous refrigeration setting.

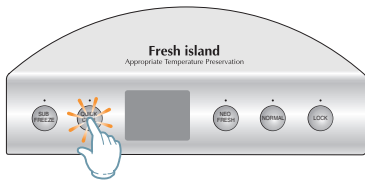



■ Function selection

3 When NEO FRESH is selected



▶ When NEO FRESH is selected, the temperature of the Fresh Island will be set to 30°F and the temperature of the fridge compartment will be maintained at 30°F regardless of its temperature setting.

▶ 30°F is a temperature which water in food is on the verge of freezing. With this temperature, you can freshly keep meat or fish that you are about to cook.

4 When NORMAL is selected

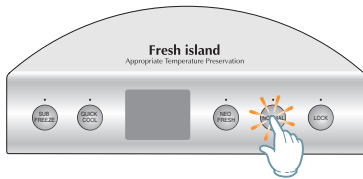

▶ When NORMAL is selected, the Fresh Island panel will display 38°F set at the Fresh Island temperature control, and the Fresh Island will be controlled based on 38°F .

5 When LOCK is selected



▶ The system will be locked with its current setting and all the function buttons can not be changed.

▶ To cancel the LOCK function, press the LOCK button once more .



Note

- Do not put food, vegetables or fruits with high water content in the Fresh Island.

- It can freeze them.
- Water contained in food starts begins to freeze at 30°F or 23°F. So, beverages such as fruit punch and juice, vegetables and fruits could became frozen.

- Different types of beverages and foods may have different cooling times.



4 ARRANGEMENT AND ADJUSTMENT

1) Machine Compartment Fan Motor Delay Function

- This refrigerator is programmed to control its temperature automatically in accordance with the ambient temperature. The Compressor Cooling Fan (Machine Compartment Fan) is controlled according to the ambient temperature.
- ※ Refer to the manual for ambient temp range and cooling fan operation.

	Temperature Range	Load Operation State
Machine Compartment Delay	Above 51.8°F (11°C)	With the COMP on, Fan will be on immediately
	Between 46.4°C (8°C) and 50°C (10°C)	After 5 minutes of the Comp On, Fan will be on
	Below 44.6°F (7°C)	Comp will be on and Fan will be off

2) ICE-MAKER Function

① INITIALIZATION (INITIAL POWER ON)

It is an operation for checking that the ice maker is good after the initial power on.

- 1) When the power is applied for the first time, the ejection arm will be rotated by rotating the ice eject motor clockwise.
- 2) During the ejection arm rotating, supply water for 0.5 seconds.

※ SUMMARY

Power on → Ice maker finds horizontal position → Stand by for 46 minutes → After 46 minutes it will check the ice temp → If ice temp is OK, it will eject the initial ice cubes.

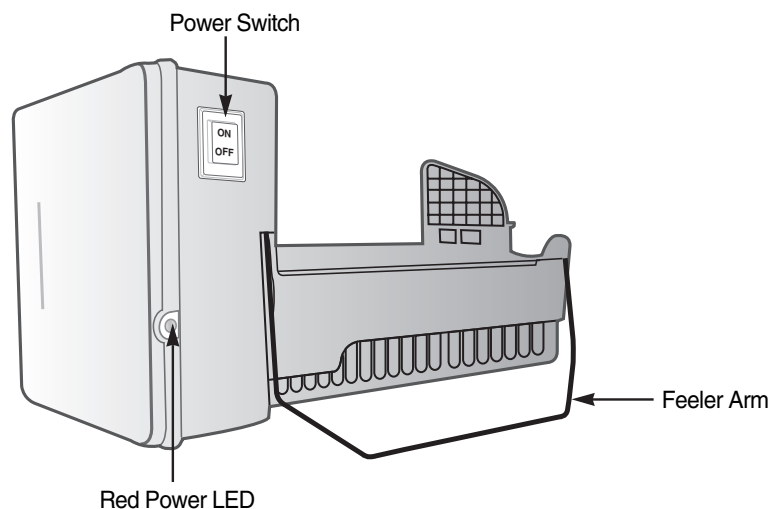



② WATER SUPPLY FUNCTION

- ▶ It is an operation that water is supplied to the ice tray using a solenoid valve connected directly to the water line when ice ejection is completed.
 - 1) When the ejection arm is in the horizontal state and the completion of the ejection operation, operate the water solenoid valve with a Time check function to supply water to the ice tray.
 - 2) Once it is supplied with water, it waits for at least 46 minutes and when the temperature of the ice maker sensor remains below 18.5°F for 41°F seconds, it carries out the normal ejection and supplies water again.
 - 3) Water is to be supplied regardless of the F/R-Door opening.

③ ICE PRODUCTION FUNCTION

- ▶ The water in the ice tray is judged as completely frozen after the completion of water supply operation. Ice making will be terminated by the temperature of the ice maker sensor.
 - 1) When the ice maker sensor is maintained lower than 18.5°F for 5 seconds, it will be evaluated as the completion of ice making.
 - It will not check the ice maker sensor within 46 minutes from the water filling. (Safety function for cold air leak or sensor error)
 - 2) It will check the temperature from the ice maker after the water filling.
 - It will not carry out the ejection even though the temperature goes down below 18.5°F
 - 3) If the temperature of the ice maker sensor is maintained below 18.5°F for more than 5 seconds, it carries out the ice ejection.

④ EJECTION FUNCTION

- ▶ After completion of ice making, the operation of ice separation from the ice tray will be carried out.
 - 1) To separate ice from the ice tray, ejection arm will be rotated by rotating the Eject Motor clockwise.
 - 2) When the ejection arm is restored to the horizontal position the operation of ice separation from the ice tray finishes.
 - 3) If the detection of ice bin is full, the operation of ice separation from the ice tray will not be carried out.

⑤ TEST FUNCTION

- ▶ To operate manually the ice maker, move the feeler arm up and down three times in 16 seconds after initial power on.
 - 1) When moving the feeler arm up and down three times in 16 seconds after initial power on, the Ice eject motor will rotate ejecting ice regardless of the elapsed time of 46 minutes and the ice making temperature. Then it will be restored to the horizontal position and supply water to the ice tray.
 - 2) Operate normally regardless of the F,R-door opening.

⑥ OPERATING ERROR

- ▶ When the ice maker dose not operate properly, the LED blinks continuously.
 - 1) Turn the ice maker power switch on and off.
 - 2) If the ice cubes stuck in ice maker, turn off the ice maker and remove cubes and turn the ice maker back on.

Note Ice Dispenser function stops working when the F-Door is open. If the ice dispenser is operated when the F-Door is open, the ice falls on the floor, the water dispenser operates normally regardless of the door opening.



3) Defrost Function

- 1) F/R-Room Defrost depends on the accumulated comp-on time.
- 2) With the initial power on, defrost starts at the both rooms after 4 hour accumulated comp-on time.
- 3) Defrost cycle is changed automatically from MIN 5 hours to MAX 10 hours.
- 4) The defrost cycle depends on the ambient temperature, the frequency of F/R- Door open, and the duration of F/R-Door Open.
- 5) The Defrost Heater Off temperatures are compared using the temperature values of R-Defrost Sensor and F-Defrost Sensor and they are as follows:

Category	Fridge	Freezer	Remarks
	All cases	All cases	
General Defrost Condition	63°F (Refer to options)	54°F (Refer to options)	For A/S
Forced Defrost Function			

4) ALARM Function

① Button Touch Tone

- 1) When selecting each button on the Control Panel, the Button Touch Sound is heard.
- 2) In the case of pressing more than two buttons at the same time or pressing a wrong button, the sound will not be heard.

② DOOR-OPEN Alarm

- 1) After 2 minutes of the F/R-Room is open, the alarm goes off.
- 2) If the door continues to be open after that, the alarm will be heard every 2 minutes cycle.
- 3) The alarm stops immediately when both of the F/R-Doors are closed.



5) Load Status Display Function

- 1) When pressing the POWER FRE. and the POWER REF. buttons simultaneously for about 6 seconds during normal operation, the F/R-Room temperature LCD blink for 2 seconds at an interval of 0.5 sec on/off..
At this point, when taking your finger off the POWER FRE. and the POWER REF. buttons and pressing the REF. TEMP temp button, it goes into the Load Status Display.
- 2) The Load Status Display shows the load in operation in real time. (what is operating at the time)
However, it is not related to the actual operation status of load. It only shows the load operation command from MICOM.
- 3) The LCDs for only the loads in operation blink repeatedly. (segments of the display will blink)
- 4) The Load Status Display continues for 30 seconds and then is restored to the normal display.

Press them simultaneously for 6 seconds and then the R-Room ①

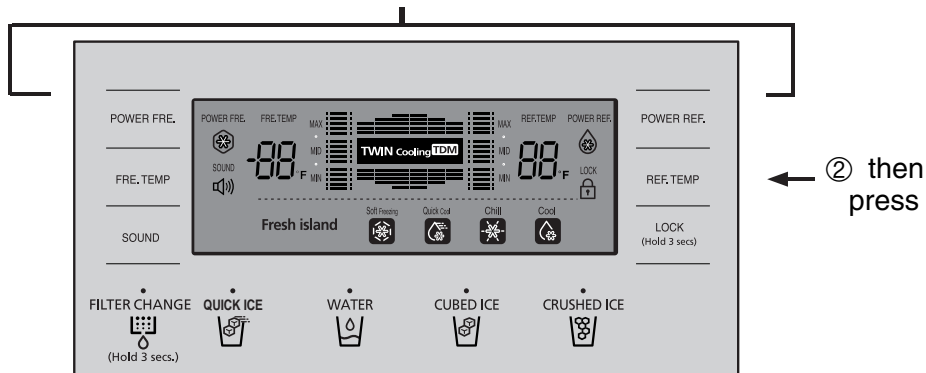

6) Restoration of Operation Conditions during Power Failure

- 1) Power failure or initialization of the Panel Display can cause the customer to call for service.
To avoid this, if the power on, it determines the temperature of the F-Room to decide whether to go into initialization or to restore the previous operation conditions.
- 2) With the initial power is on, it determines the temperature of the F-Room. If it is below 41 °F, it considers it as power failure and restores previous functions (POWER. FRE, POWER. REF F- and R-Room Settings, ICE Types, etc.) related to the PANEL DISPLAY.
- 3) With the power is on, it determines the temperature of the F-Room. If it is over 41 °F, it considers it as extended power failure and starts to initialize the PANEL DISPLAY (Automatic setting as the F-Room at 0°F and the R-Room at 38°F and ICE CRUSHED).



● Details of Load Status Light Display by Position

No	Items	DISPLAY LED	Trouble shooting
1	R-FAN HIGH	FRIDGE SEGMENT 	The relevant segment LED comes on when the R- FAN HIGH operates.
2	R-FAN LOW	FRIDGE SEGMENT 	The relevant segment LED comes on when the R- FAN LOW operates.
3	R-Defrost Heater	FRIDGE SEGMENT 	The relevant segment LED comes on when the R- Defrost Heater operates.
4	START MODE	FRIDGE SEGMENT 	The relevant segment LED comes on when the refrigerator is provided with initial power.
5	Condition under Overload	FRIDGE SEGMENT 	The relevant segment LED comes on when the peripheral temperature is over 95°F.
6	Condition under Low Temperature	FRIDGE SEGMENT 	The relevant segment LED comes on when the peripheral temperature is over 63°F.
7	Exhibition Mode	FRIDGE SEGMENT 	The relevant LED comes on in the Exhibition Mode.
8	Damper	FRIDGE SEGMENT 	During Damper Open LED segment ON
9	R-Valve Open	FRIDGE SEGMENT 	During R-Valve Open LED segment ON
10	COMP	FRIDGE SEGMENT 	The relevant segment LED comes on when the COMP operates.
11	F-FAN HIGH	FREEZER SEGMENT 	The relevant segment LED comes on when the F- FAN HIGH operates.
12	F-FAN LOW	FREEZER SEGMENT 	The relevant segment LED comes on when the F- FAN LOW operates.
13	F-Defrost Heater	FREEZER SEGMENT 	The relevant segment LED comes on when the F-Defrost Heater operates.
14	C-FAN HIGH	FREEZER SEGMENT 	The relevant segment LED comes on when the C-FAN HIGH operates.
15	C-FAN LOW	FREEZER SEGMENT 	The relevant segment LED comes on when the C-FAN LOW operates.
16	Dispenser Heater	FREEZER SEGMENT 	The relevant segment LED comes on when the Dispenser Heater operates.
17	F-Valve Open	FREEZER SEGMENT 	During F-Valve Open LED segment ON
18	Dispenser Heater	FREEZER SEGMENT 	When the peripheral temperature is 64°F ~ 93°F, both "E,F"LED in the last digit in R-Room is off.



7) Test Function (Forced Operation/Forced Defrost)

- When pressing the REF. TEMP Temp Control button and the POWER FRE button on PANEL P.C.B at the same time for more than 8 seconds, all LEDs on the display go out and it goes into the Test function. You can use any of F/R-Room buttons, POWER FRE button and POWER REF button as a Test button.
- If press TEST KEY, the Test function will be selected in the order of forced operation 1 (FF 1)→forced operation 2 (FF 2)→forced operation 3 (FF 3)→forced R, F defrost(fd) Cancellation (steady operation)→forced operation 1 (FF 1)
If you want to cancel the function during TEST function achievement, power ON after OFF is the most desirable method.

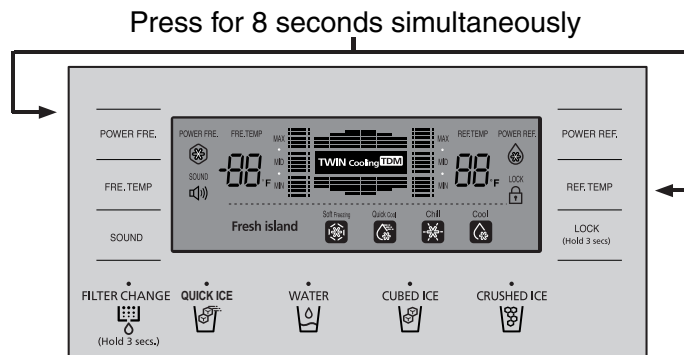

① Forced Operation Function

- 1) If press Test Key 1 times in Test Mode, Display is registered by FF1 and means forced operation 1. This time, Buzzer achieves warning at Beep sound.
- 2) FF3 is displayed if press FF 2, 1 times more if press Lock key 1 times more in forced operation 1 and each means forced operation 2,3 and each moves differing each Comp's RPM.
- 3) When the Forced Operation is selected, the Comp operates immediately without a 5-minute delay. This time, defrost has to be discontinued immediately if it is doing defrost.
- 4) When the Forced Operation is selected, the F & R-Room temps will be automatically selected to -13°F and 34°F respectively. But, when the Forced Defrost or Test cancellation is selected after 1 minute elapsed while Forced Operation, the temperatures do not change they will be maintained at "-13°F" and "34°F", and when the forced defrost or Test operation is cancelled within a minute or the Forced Operation selection, the temperatures change to the previously selected temperatures.
- 5) Upon completion of the Forced Operation (24 hours), both compartments perform a Defrost regardless of their previous operating conditions.
- 6) After the above, Defrost operates under normal defrost conditions according to the setting controlling the R-Defrost.
- 7) When the Forced Operation is cancelled before it is completed (changing to the cancellation function), the comp-on time during the Forced Operation will be added in the defrost cycle.
- 8) During the Forced Operation, the POWER FRE. does not work. (All the buttons work normally). When the POWER FRE. function is selected, the relevant LED lights up and it goes off in about 10 seconds.

② Forced Defrost Function

- 1) If press Lock key more 1 times in forced operation 3 (FF 3) Display is registered Fd forced operation immediately canceled, defrost of F and R achieve at same time.
- 2) This time, Beep alarm sound produces while achieve forced F, R defrost operation at 0.75 seconds ON/0.25 seconds OFF sound after ring for 3 seconds from injection visual point.

Note If the Heater turns on during the Forced R-Defrost and the simultaneous Forced F/R-Defrost is selected, before the Defrost completes, it won't turn off the R-Heater but compare its temperature with that of R-Eva.

③ Test Cancellation Mode

- 1) When converting the Display Panel into the Test mode and pressing a Test button once more during the simultaneous Forced F/R-Defrost, the Forced operation will be cancelled simultaneously and restored to its normal operation. In addition, if the power is turned off and on all the Test functions are cancelled.



8) Self-Diagnosis Function

Press for 8 seconds simultaneously

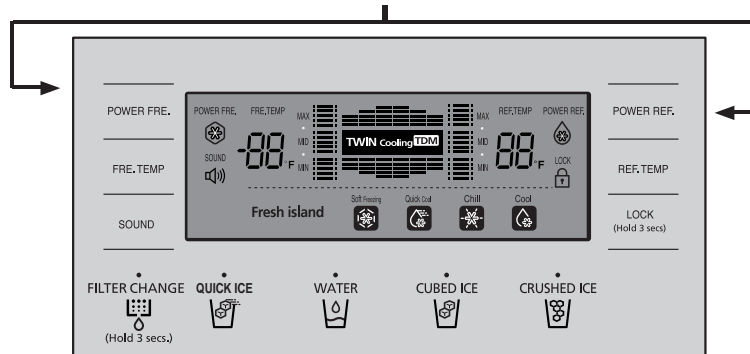

① Self-Diagnosis with Initial Power On

- 1) With power on, MICOM checks the temperature sensors for errors in a second.
- 2) A defective sensor is found by self-diagnosis, relevant display LED segments will flash on and off at intervals of 0.5 sec. there will be no beep sound. Even though sensor has a defect, the system will operate emergency mode.
- 3) When display LED segments are blinking with defective sensors found, it only recognizes the self-diagnosis button (Press POWER REF. and POWER REF. buttons for 8 sec.) normal temp control will be on hold.
- 4) After self-diagnosis error, when the faulty sensor is repaired or when the POWER FRE. and the POWER REF. buttons are pressed for 8 sec, the initial self diagnosis will be canceled.

② Self-Diagnosis during normal operation

- 1) When pressing the POWER FRE. button and the POWER REF. simultaneously for 6 sec during normal operation, the entire temperature setting display will blink for 2sec at the interval of 0.5 sec then when pressing the POWER FRE. button and the POWER REF. button simultaneously for 8 sec including 2 sec blinking, self-diagnosis will be selected.
- 2) At this point, the sound goes off and the refrigerator goes into the self-diagnosis.
- 3) When the self-diagnosis starts, the entire LEDs turn off and the error related LED segments blink indicating errors. (See the Self-Diagnosis Checklist below)
- 4) When an error occurs, it will be displayed for 30 seconds and then restored to the normal status regardless of its fault.
- 5) During the self-diagnosis, button selections will not be recognized.

③ MICOM Communication Error

- 1) If any communication error between door Panel ↔ Main MICOM is maintained for 10 seconds with the power on, the refrigerator is converted to Communication Error Display mode.
- 2) Then, the entire display panel blinks at the interval of 0.5 sec on and 0.5 sec off until the error is corrected.
- 3) When a communication error occurs between Main ↔ Load after normal operation, the communication between door Panel ↔ Main MICOM with the initial power on, Main MICOM immediately sends the error message between Main ↔ Load to the door Panel, and the Panel MICOM immediately goes into the Main ↔ Load Communication Display mode.
- 4) Then, the entire display panel blinks at the interval of 0.5 sec on and 0.5 sec off until the error is corrected.

Category	Communication Error between door Panel ↔ Main	Communication Error between Main ↔ Load
Display Options	0.5 sec all on/0.5 sec all off	0.5 sec all on/0.5 sec all off
Button Recognition	None	
Display Range	Proceed until the communication error is corrected.	
Display Priority	"Communication Error between door Panel ↔ Main" has priority over "Communication Error between Main ↔ Load."	



● Details of Self-Diagnosis Light Display by Position

No	Items	DISPLAY LED	Trouble shooting	Remarks
1	R-SENSOR	FRIDGE SEGMENT 88	Sensor Housing slip-out from the R-Room, Contact Failure, Wire Cut, Wire Short, Defective R-Sensor.	Displaying a defect when the R-Sensor temp is over 149°F (65°C) or below -58°F (-50°C).
2	R-DEFROST SENSOR	FRIDGE SEGMENT 88	Defrost Sensor Housing slip-out from the evaporator of R-Room, Contact Failure, Wire Cut, Wire Short, Defective Sensor.	Displaying a defect when the R-Defrost Sensor temp is over 149°F (65°C) or below -58°F (-50°C).
3	R-FAN ERROR	FRIDGE SEGMENT 88	Errors in operation of R-FAN Motor, Contact failure of feedback signal wire, no motor wire.	Displaying a defect when F.G signals generated during operation of FAN-Motor are not input.
4	FRESH-SENSOR	FRIDGE SEGMENT 88	Fresh-Sensor Housing slip-out, Contact Failure, Wire Cut, Wire Short, Defective Fresh-Sensor.	Displaying a defect when the Fresh-Sensor temp is over 149°F (65°C) or below -58°F (-50°C).
5	R-DEFROST ERROR	FRIDGE SEGMENT 88	R-Heater Housing slip-out, Contact Failure, Wire Cut, Wire Short, Defective R-Heater, Defective Defrost Temp Fuse.	Displaying a defect when the R-Defrost completes automatically in 50 minutes.
6	AMBIENT TEMPERATURE SENSOR	FREEZER SEGMENT 88	Ambient Temperature Sensor Housing slip-out, Contact Failure, Wire Cut, Wire Short, Defective Ambient Temperature Sensor.	Displaying a defect when the Ambient Temperature Sensor temp is over 149°F (65°C) or below -58°F (-50°C).
7	F-SENSOR	FREEZER SEGMENT 88	Sensor Housing slip-out from the F-Room, Contact Failure, Wire Cut, Wire Short, Defective F-Sensor.	Displaying a defect when the F-Sensor temp is over 149°F (65°C) or below -58°F (-50°C).
8	F-DEFROST SENSOR	FREEZER SEGMENT 88	F-Defrost Sensor slip-out from the evaporator of the F-Room, Contact Failure, Wire Cut, Wire Short, Defective Sensor.	Displaying a defect when the temp sensing of the F-Defrost Sensor is over 149°F (65°C) or below -58°F (-50°C).
9	F-FAN ERROR	FREEZER SEGMENT 88	Errors in operation of F-FAN Motor, Contact failure of feedback signal line, no motor wire, etc.	Displaying a defect when the F.G signals generated during operation of FAN-Motor are not input.
10	C-FAN ERROR	FREEZER SEGMENT 88	Errors in operation of C-FAN Motor, Contact failure of feedback signal line, no motor wire.	Displaying a defect when the F.G signals generated during operation of FAN-Motor are not input.
11	F-DEFROST ERROR	FREEZER SEGMENT 88	F-Heater Housing slip-out, contact failure, wire cut, wire short, Defective F-Heater, Defective Defrost Temp Fuse.	Displaying a defect when F-Defrost completes automatically in 50 minutes.
12	MAIN_LOAD ERROR	FREEZER SEGMENT 88	Defective Main PCB Pattern and MICOM	Displaying a defect when errors occur between main MICOM and load MICOM
13	MAIN_PANEL ERROR	FREEZER SEGMENT 88	Defective PCB, Housing slip-out, Contact Failure, Wire Cut, Wire Short, Defective MICOM.	Displaying a defect when errors occur between main MICOM and panel MICOM
14	DAMPER HEATER ERROR	FRIDGE SEGMENT 88	Defective PCB, Housing slip-out, Contact Failure, Wire Cut, Wire Short, Defective MICOM.	Displaying a defect when errors occur between main MICOM and panel MICOM



9) Option Setting Function

- When pressing the FRE. TEMP and the POWER REF. buttons simultaneously for 12 seconds, the Display is converted to the Option Setting mode.

Press simultaneously for 12 seconds

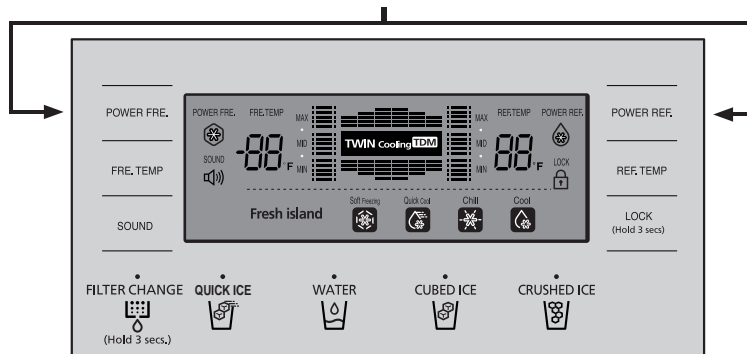

- ① For example, if you want to shift the standard temperature of the Freezer by -3°F , follow the procedure.
 This function is to change the standard temperature. If the F-Room is set to 0°F , and you lower it by -3°F extra using this option, it will be controlled within -2°F , when you lower the standard temperature by -3°F , the F-Room will be -3°F lower than the temperature shown on the display.

- 1) Press the FRE. TEMP and the POWER REF. buttons simultaneously for 12 seconds as shown in the figure.
 All the Display goes off except the FRE. TEMP and the REF. TEMP temp LEDs.
- 2) Now it changed to the Option mode, "0" for FRIDGE and "0" for FREEZER will light up on the display.
 (It is set to "0" for FRIDGE and "0" for FREEZER but can be changed for the purpose of quality improvement.)
 - If "0" on FRIDGE lights up, the Freezer temperature option item can be set and the current temperature setting of the Freezer will be shown on the FREEZER.
- 3) After setting "0" to the FREEZER and selecting "6" as shown in the Freezer option chart next page, the standard Freezer temperature will be lowered by -3°F . (See the figure on the temperature changes of the F-Room). In 20 seconds after the temperature is adjusted, MICOM stores this set value in EEPROM and restores the normal Display and exits the Option Setting mode.
- 4) It is possible to control the Fridge temperature, the Water Supply, the Ice-Maker Sensor temperature, the Fresh Island temperature in the same way as shown above.
- 5) Since the option is already set in the EEPROM at the factory, do not change it randomly except for special conditions the option setting completes when it restores the normal Display in 20 seconds, do not turn it off before the normal display is restored.



Note All the data for the Option is cleared before leaving the factory.
 All the setting values are "0" However, some units can have different setting values for the purpose of quality improvement during mass production. Please make sure to check the Quality Information.

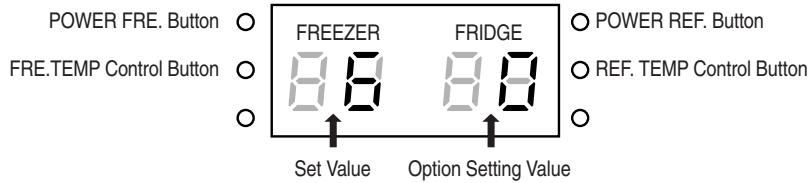

Example) To increase the standard temperature of the FRIDGE by 34.7°F (1.5°C).

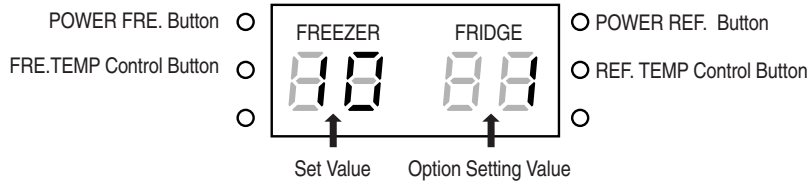

4-16) Option Table

Note By pressing the FRE. TEMP button and the POWER REF. button, various options including the above functions can be set. They are items related to controlling the refrigerator and having no relevance to A/S. So, (Do not set options except those in A/S Manual above.)

① Table for changing temperature in the F-Room

Set Item	FREEZER TEMP SHIFT
MODEL	QUEEN -PJT
DISPLAY	Position:FRIDGE 7-SEG
	0

Set Item	Common	Set Item	Common
FREEZER 7-SEG		FREEZER 7-SEG	
0	32°F	8	33°F
1	31°F	9	34°F
2	30°F	10	35°F
3	29°F	11	35.6°F
4	28.4°F	12	36.5°F
5	27.5°F	13	37.4°F
6	26.6°F	14	38°F
7	26°F	15	39°F

① Table for changing temperature in the R-Room

Set Item	FRIDGE TEMP SHIFT
MODEL	QUEEN-PJT
DISPLAY	Position:FREEZER 7-SEG
	1

Set Item	Common	Set Item	Common
FREEZER 7-SEG		FREEZER 7-SEG	
0	32°F	8	33°F
1	31°F	9	34°F
2	30°F	10	35°F
3	29°F	11	35.6°F
4	28.4°F	12	36.5°F
5	27.5°F	13	37.4°F
6	26.6°F	14	38°F
7	26°F	15	39°F



■ The following options are applied only to the models with Ice Maker (Dispenser-model).

③ This is the option controlling the quantity of the automatic water supply with the Flow Sensor controlling water quantity to Ice Maker.

Set Item	FRIDGE Display
Automatic water supply control to Ice Maker	2

Automatic water supply	FREEZER Display
85cc	0
90cc	1

④ This is the option operating when the Flow Sensor controlling water quantity to Ice Maker has error.
(Same as DIP button of ZIPEL Refrigerator)

Set Item	FRIDGE Display
Water supply control of Ice Maker	3

Automatic water supply	FREEZER Display
5 sec.	0
4 sec.	1
3 sec.	2
6 sec.	3
7 sec.	4
8 sec.	5
9 sec.	6
10 sec.	7
12 sec.	8
13 sec.	9
15 sec.	10
17 sec.	11
19 sec.	12
21 sec.	13
23 sec.	14
25 sec.	15

⑤ This is the option to change the standard temperature of Ice Maker Sensor.

Set Item	FRIDGE Display
Standard Temp Control of Ice Maker Sensor	4

Temperature detected by Ice Maker Sensor	FREEZER Display
22°F	0
20°F	1
18°F	2
16°F	3
14°F	4
12°F	5
10°F	6
8°F	7

⑥ Fresh Island Temp Shift Function This is the option to change the standard temperature controlled for the Fresh Island.

Set Item	FRIDGE Display
Fresh Island Temp Shift (Change the standard temp.)	20

Ice Maker Sensor Temp	FREEZER Display
32°F	0
31°F	1
30°F	2
29°F	3
33°F	4
34°F	5
35°F	6
35.6°F	7



5 How to Disassemble Each Component for A/S

 Make sure to turn the refrigerator off before disassembling the components as shown below.

1) The descriptions of external parts are illustrated in the figure below, and the methods of disassembling the parts are indicated in order for you to refer to the relevant page, assigned to each number below.

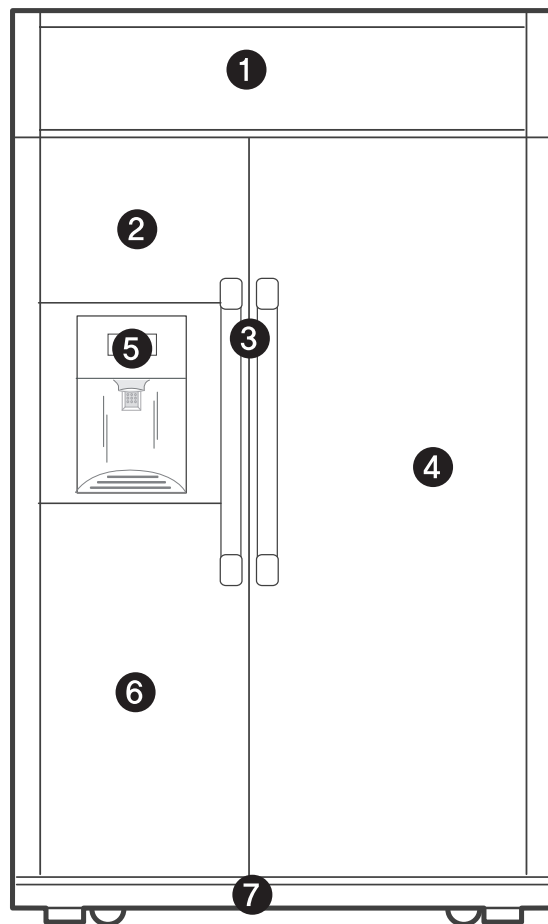

NO	Description	Page
❶	Machine Compartment Cover	45
❷	Upper Custom Panel of F-Room	45
❸	Door Handle	45
❹	Custom Panel of R-Room	45
❺	Dispenser	44

NO	Description	Page
❻	Lower Custom Panel of F-Room	45
❼	Leg Cover	45



⚠ Make sure to turn it off before disassembly. Risk of electric shock.

PART NAME	DESCRIPTION	FIGURE
DISPENSER-COVER	① Disassemble circled Tray Dispenser, disassemble the Cover turning the two screw counter-clockwise, Dispenser pushing and lifting up. ② Disassemble the connector like figure 2.	
DISPENSER-DISPLAY	① Disassemble dispenser cover, unscrew 4 screws and remove Lamp cover. ② Disassemble the LCD Assy connector like figure. ③ Unscrew three screws from the LCD.	
DISPENSER-SUPPORT MICRO SWITCH	① Disassemble Dispenser cover, disassemble the circled 4 screws from the assembly. ② Disassemble the connector like figure 2. ③ Pull the circled ribs like figure and then pull out the Micro S/W	
DISPENSER-Ass'y COVER ICE ROUTE	① Disassemble Dispenser cover(refer to...), pull out the Guide Ice Dispenser to the front. ② Push the Ass'y Cover Ice Route to the left using a tool like screw driver and pull out.	
DISPENSER-CAM GEAR MOTOR	① Disassemble Dispenser cover(referred to...), disassemble the circled 2 screws from the assembly. ② Disassemble the Cam from the Motor like figure 2. ③ Disassemble the circled 2 screws and then pull Motor out.	
DISPENSER-PUSH LEVER MICRO SWITCH	① Disassembling Dispenser cover(referred to...), push a tool like 'scREW' driver into the gap and pull out. ② Push out the rib like figure and then pull out Micro Switch.	



⚠ Make sure to turn it off before disassembly. Risk of electric shock.

PART NAME	DESCRIPTION	FIGURE
DISPENSER-BULB	① Disassemble Turning the two screw counter-clockwise, Lamp Cover like figure, ② now it is possible to change Bulb.	
HANDLE	① Disassemble the 7screws at the side. ② Disassemble circled 1 screw at the upper section. ③ Disassemble the circled 1 screw at the bottom section.	
ASSY-COVER COMP	① After opening the Assy Grill, disassemble 6 screws and pull out the Cover.	
DECORATION PANEL : FREEZER UPPER PART	① Disassemble the Handle. ② Pull the panel out to the Handle side like figure 2. ※ Refer to the this method to disassemble the Freezer lower part and Fridge part.	
FREEZER DOOR	① Disassemble grill cover, disassemble the fixing Clamp and Earthing wire. ② Untie the plastic packing for protecting water and then disassemble the 2 housings of wire. ③ Disassemble the circled 3 blots (ø 10mm). ④ Pull out Cap Link B after disassembling a bolt using open wrench (ø 8mm) ⑤ Pull out Cap Link A from the Hinge. ⑥ Disassemble the circled 2 screws to disassemble Leg Front.	



⚠ Make sure to turn it off before disassembly. Risk of electric shock.

PART NAME	DESCRIPTION	FIGURE
<p>FREEZER DOOR</p>	<p>⑦ Disassemble the circled fixing screw for Water Line.</p> <p>⑧ Push the inner coupling using one hand and pull out Water Line from the coupling using the other hand.</p> <p>⑨ Disassemble clamp and pipe for protecting Water Line after disassembling circled 2 screws, push the upper Hinge in figure 10 to pull out wires.</p> <p>⑩ At least 2 people need to disassemble the Freezer Door because there is a risk tipped-over so, one man pull to out the door by lifting up and the other man push the Water Line through lower Hinge.</p> <p>※ Be careful not to hurt wires and Water Line.</p>	
<p>DOOR UPPER CHASSIS AT FREEZER</p>	<p>① Disassemble the circled 8 screws and pull out.</p> <p>※ Freezer lower Chassis : Disassemble 5 screws same as Upper Chassis.</p>	
<p>FRIDGE DOOR</p>	<p>① Disassemble Cover Grill, disassemble the fixing Clamp and Grounding wire.</p> <p>② Disassemble the circled 3 blots (∅ 10mm).</p> <p>※ Refer to the FREEZER DOOR disassembly</p>	



⚠ Make sure to turn it off before disassembly. Risk of electric shock.

6-2-2. Interior Overview

The descriptions of internal parts are illustrated in the photo below and refer to the pages below for disassembling each part. For the parts not illustrated in the photo, refer to the exploded view.

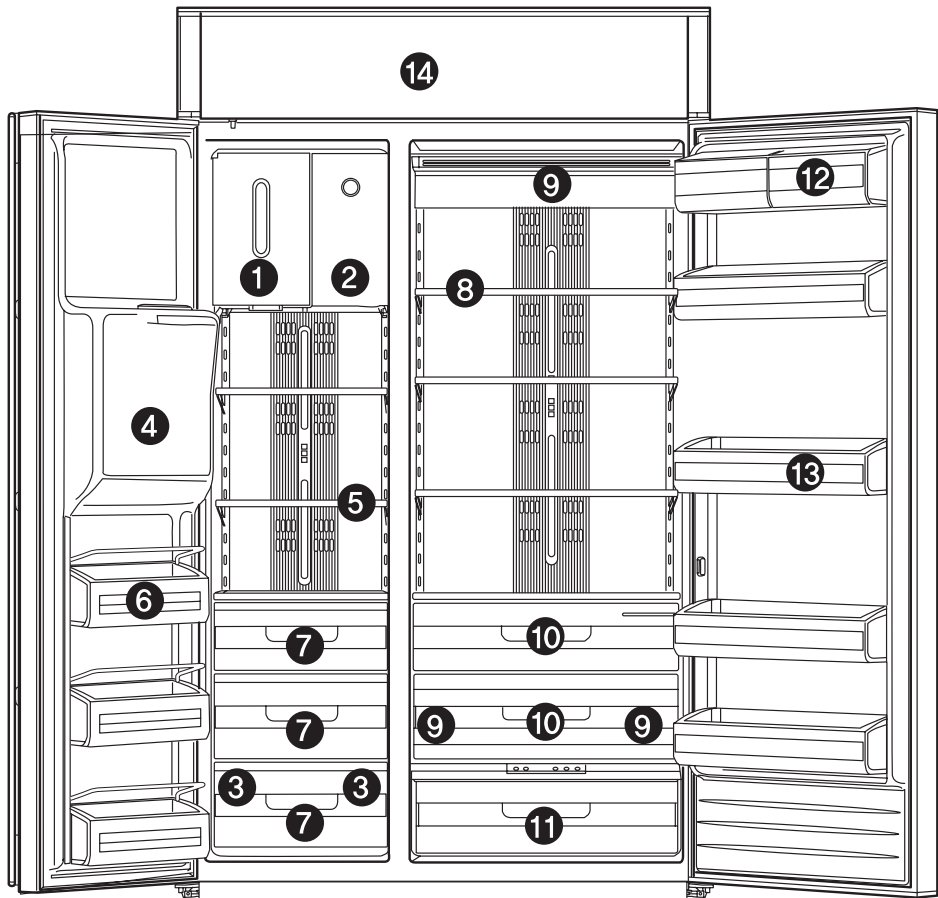

NO	Description	Page	NO	Description	Page
①	Ice Storage Bin	48	⑨	R-Room Lamp	53
②	Winter Closet	49	⑩	Veg/Fruit Drawer	48
③	F-Room Lamp	51	⑪	Fresh Island	52
④	Ice Chute		⑫	Dairy Bin	48
⑤	F-Room Shelf	48	⑬	R-Room Utility Bin	
⑥	F-Room Utility Bin		⑭	Grille Panel	54
⑦	Dry Room/ Meat Drawer	48			
⑧	R-Room Shelf	48			



⚠ Make sure to turn it off before disassembly. Risk of electric shock.

PART NAME	DESCRIPTION	FIGURE
Ice Storage Bin	① Hold the bottom of the left long slot with your hand, lift up and pull forward to remove it.	
R-Room – Dairy Bin Cover	① Flip the cover up and push it back to the direction as indicated with the arrow marks, and lift it up to remove it.	
Dairy Bin	① Lift Dairy Guard up with both hands and remove it.	
Shelf (Common to R- and F-Room)	① Hold the shelf with one hand and lift the rear up with the other hand, and pull it forward.	
Drawer (Common to R- and F-Room)	① Pull forward until it stops at the retaining hook, then lift it up and pull out. Make sure not to damage the door gasket with the sharp corners of the draw.	







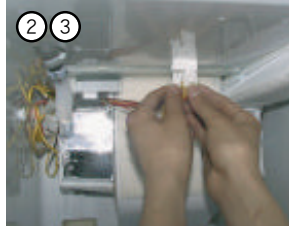

⚠ Make sure to turn it off before disassembly. Risk of electric shock.

PART NAME	DESCRIPTION	FIGURE	
Ice Maker	<p>① Remove the Ice Storage Bin then lift up the cover of Winter Closet to the direction of the arrow mark to remove. (Insert the spring into its seat when assembling it again.)</p> <p>② Pull the partition out with the center of the shelf pressed down as shown in the photo, and remove the 2 screws below at the right left sides to disassemble the Auger Motor Ass'y. Pull the Ass'y out slightly to remove the wire housing on the rear left of the auger motor.</p> <p>③ Remove the 2 screws over the Ice Maker and the power cord housing, pull the Ice Maker Kit forward to disassemble.</p> <p>④ Lift up the rear cover of the Auger Motor Ass'y to disassemble. When replacing the Ice Maker Geared Motor, remove the 2 screws indicated with the arrow marks in the photo.</p> <p>⑤ When replacing the Auger Motor, remove the 4 screws indicated with the arrow marks and remove the hex-nut at the motor axis to take the motor body and the rotation blade apart, finally remove the housings off the parts to replace.</p>		
F-Room Evaporator	<p>① Loosen the 4 screws to remove the upper cover of the F-Room remove the screw from the cover of the F-Room Evaporator after taking out the screw cap. To remove the cover, only remove the screw on the inner side of the auger motor support and have the support hanging.</p>		

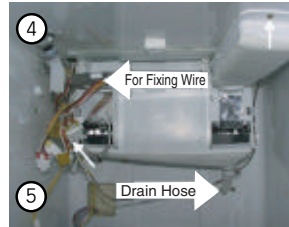
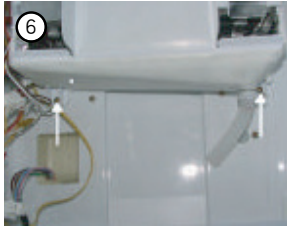
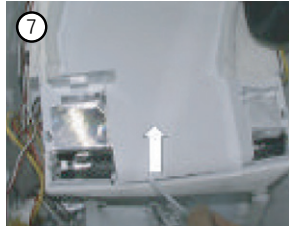

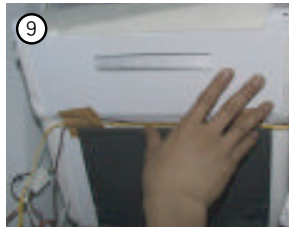
⚠ Make sure to turn it off before disassembly. Risk of electric shock.

PART NAME	DESCRIPTION	FIGURE
<p>F-Room Evaporator</p>	<p>② After removing the housing from the left wall and the sensor housing on the upper side, pull the evaporator cover out as shown in the photo.</p> <p>③ Remove the fan motor housing and the heater housing, and pull the upper duct out from the F-Room.</p> <p>④ You can remove the flexible pipe drain heater off the evaporator after removing the 2 screws and the power cord housing indicated with the arrow mark.</p> <p>⑤ Pull the drain hose out, put it aside and remove the wire holder.</p> <p>⑥ Remove the 2 screws that hold the evaporator case, and lower the evaporator down slowly in order not to have the flexible pipe bend.</p> <p>⑦ Release the wire from its retainer and pull the bottom side of the evaporator cover down as shown in the photo.</p> <p>⑧ Release the six retaining hooks from both walls using a flat-blade screwdriver and take the front cover apart.</p> <p>⑨ Turn the evaporator slowly upside down so the flexible pipes are kept in line.</p>	       
<p>F-Room Evaporator – Fan Motor Ass'y</p>	<p>① Refer to the F-Room Evaporator Disassembly loosen the 4 motor clamp screws as shown in the left photo to remove the Motor Ass'y.</p>	



⚠ Make sure to turn it off before disassembly. Risk of electric shock.

PART NAME	DESCRIPTION	FIGURE
<p>F-Room Evaporator – Defrost Heater/Bimetal/Defrost Sensor</p>	<p>① F-Room Evaporator –After removing the Fan Motor Ass'y as shown in the photo, remove the clamp screw holding the evaporator.</p> <p>② Turn the evaporator over again to pull it out from its case.</p> <p>③ If necessary,remove Defrost Heater/Bimetal/Defrost Sensor by removing the clamp screws and the clips.</p>	
<p>F-Room Evaporator – Drain Heater</p>	<p>① Remove the inner case and release the drain pan from the retaining hook at the place indicated with the white arrow mark.</p> <p>② Take the drain heater out and remove its housing.</p>	
<p>F-Room – Interior Lamp</p>	<p>① Remove the drawer.</p> <p>② When replacing only the lamp, disassemble the lamp cover after removing the screw indicated with the white arrow mark, to take an example of the left indoor lamp from the first photo, and pull the glass forward to replace the lamp.</p> <p>③ When you replace the Lamp-Bimetal Ass'y, separate the lamp cover by removing the 2 screws indicated with the black arrow marks. And then, replace the bimetal clamp screws as shown in the right photo.</p>	<p>Caution The halogen lamp emits strong heat. Make sure that you turn it off first and replace it when it cools down enough.</p>







⚠ Make sure to turn it off before disassembly. Risk of electric shock.

PART NAME	DESCRIPTION	FIGURE
F-Room -Duct	<ol style="list-style-type: none"> ① Refer to the first three steps of the F-Room Evaporator to pull the upper duct out. ② Refer to the F-Room -Interior Lamp to remove the lamp cover. ③ Pull out the cover of the interior lamp at both sides of the duct from the lower side to take it apart. And then, remove the 6 clamp screws on the cold air distribution duct to remove it. 	
Rail (Common to R-and F-Room)	<ol style="list-style-type: none"> ① Refer to the drawer disassembly to remove drawers. ② Remove the screws indicated with the arrow marks. 	
Fresh Island -Thermister, PCB, LED Lamp	<ol style="list-style-type: none"> ① Refer to the drawer disassembly to remove drawers. ② Loosen the four clamp screws indicated with the black arrow marks and pull the housing off the Fresh Island out to remove the upper plate. ③ There is the Fresh Island Thermister on the bottom of the upper plate. Unscrew the 3 screws to remove the cover off the sensor. ④ To replace LED lamp, you need to replace the whole PCB board to which the lamp is mounted. 	<p>Caution Please be careful not to rip off when you remove the cover of the Fresh Island by pulling it forward.</p>
Fresh Island -LED Display	<ol style="list-style-type: none"> ① Fresh Island -Refer to the first two steps of the removal of Thermister and LED Lamp to disassemble the LED Display cover by using a flat-blade screwdriver as shown in the photo, and remove the housing inside to take the display out from the retaining hook. 	
Fresh Island -Damper	<ol style="list-style-type: none"> ① Remove the drawer, the upper frame of Fresh Island and the Fresh Island draw, and remove the connecting duct. Then, after removing the water tank and the housing at the rear of Fresh Island, disassemble the connecting duct. ② Remove the 6 screws that hold the damper at the bottom of the middle wall to remove the Damper Ass'y. 	

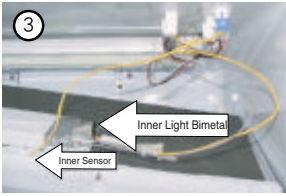

⚠ Make sure to turn it off before disassembly. Risk of electric shock.

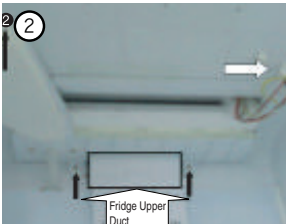
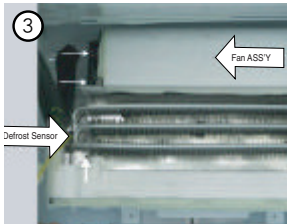
PART NAME	DESCRIPTION	FIGURE
Fresh Island -Fan	① Fresh Island –Refer to how to remove the Damper to disassemble the rear water cover and the connecting duct,remove the Fan and its trim from the retaining hook. If necessary, you can remove only the Fan clamp screw to replace the Fan.	
R-Room Sensor	① Disassemble the front Intake Grille from the retaining hook at the back. ② Remove the 5 screws to disassemble the upper cover of the R-Room, and unscrew the housing to remove the sensor.	   <p>Caution Make sure to match the housing colors.If not, it can cause a fire.</p>
R-Room Lamp	① Disassemble the front Intake Grille from the retaining hook at the back. ② Remove the 5 screws to disassemble the upper cover of the R-Room, and unscrew the housing to remove the sensor.	 <p>Caution Make sure to match the housing colors.If not, it can cause a fire.</p>
R-Room Evaporator	① Refer to how to remove the R-Room Sensor to remove the upper cover of R-Room, the drain cover and the housing. ② Remove the screws on the upper duct indicated with a arrow to disconnect the upper duct and remove the 2 screws that secure the evaporator. Then, lower the evaporator down slowly in order not to have the pipe bend. Remove the front evaporator cover to disassemble the relevant parts as shown in the photo. ③ To remove the Fan Ass'y, remove the 4 screws that hold the Fan then disassemble the housing. ④ To remove the bimetal,remove the clamp screws and pull the housing out. ⑤ Pull the Defrost Sensor out of the hole in the left side plate.	  <p>Caution Make sure to have the plastic bag to wrap the housing assembled with its opening face down in order not to gather moisture or water.</p>

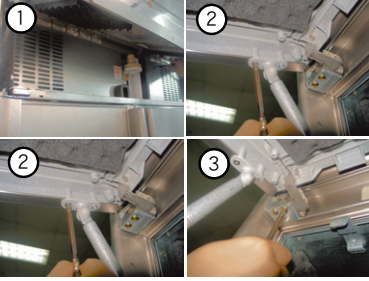
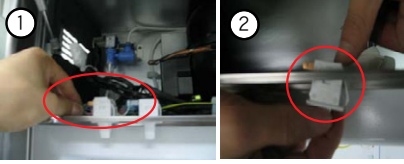
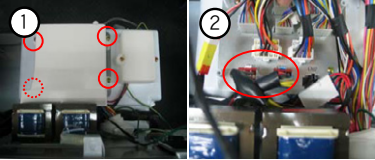
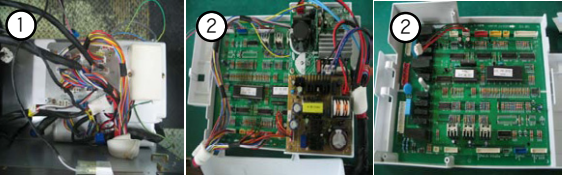

⚠ Make sure to turn it off before disassembly. Risk of electric shock.

PART NAME	DESCRIPTION	FIGURE
MACHINE COMPARTMENT	① Right figure displays the Machine Compartment.	
ASSY-GRILLE, GAS SPRING	① Open the Assy-Grille and remove Assy-cover comp. ② Remove gas struts from the stud by loosening the clip of the strut with a screw driver. ③ Unscrew two screws off the gas struts and the other two screws from the hinge.	
DOOR SWITCH	① Disassemble Cover Grill, disassemble the Housing of the switch. ② Disassemble the switch pulling down by pushing the hook.	
TRANSFORMER	① After disassembling of the Cover Grill, disassemble the circled 4 screws for Housing Cover. ② Disassemble circled wire Housing of Transformer from the terminal block. ③ Pull out Transformer after disassembling 2 screws.	
PCB-BOX	① After disassembling the Transformer, first pull out Housing connected to the terminal block, second remove 2 screws, third disassemble ground wire and finally pull out PCB-BOX Cover. ② After opening PCB-BOX Cover, pull out Housing and disassemble 4 screws to remove SMPS. ③ Disassemble Main PCB from PCB-BOX. ※ Main PCB should be fixed to a hook like figure.	



⚠ Make sure to turn it off before disassembly. Risk of electric shock.

PART NAME	DESCRIPTION	FIGURE
PCB-BOX : CONDE NSER	① Disassemble circled 2 screws. ② Pull out Condenser from PCB-BOX. ※ Be careful do not change the terminals during assembly.	
3-WAY VALVE	① Disassemble the Cover Grill, disassemble the 3 welded sections. ② Disassemble 3-way Valve then disassemble 2 screws and pull out Housing. ※ Be careful do not change the pipe during assembly (red one is for Freezer) Wrong connection of pipes alter the gas flow and cause performance issues.	
CONDE NSER FAN MOTOR	① Pull out Fan Ass'y refer to figure disassemble circled 2 screws. ② First disassemble the locking spring of Fan, second disassemble 2 screws for mounting Motor Cover, third disassemble the wire Housing and then pull out the Motor by rotating it.	
POWER SWITCH	① Disassemble (circle)2 screws mounting bracket and Housing connected to PCB-BOX then pull out Power switch from the bracket.	
INSULA TION COVER OF CONNE CTING PIPE	① Disassemble 5 screws located at the back of Power switch. ② The pipes are covered with insulation tubing left is for Freezer, right is for Fridge.	
DOOR SWITCH	① After disassembling Cover Grill, disassemble the housing of switch like in the Figure. ② Disassemble the switch by a pulling down with squeezing the lock hooks.	



⚠ Make sure to turn it off before disassembly. Risk of electric shock.

PART NAME	DESCRIPTION	FIGURE
HEATER-WATER PIPE	<ol style="list-style-type: none"> ① Remove the 2 screws over the Ice Maker and the power core housing, pull the Ice Maker Kit forward to disassemble. ② Disassemble 2 screws pull out the cover. ③ If needed, disassemble the Heater Ass'y after disassembling supply water hose. 	
WATER VALVE	<ol style="list-style-type: none"> ① Turn off Water supply, disassemble Cover Grill then, disassemble the wire Housing of the Water Valve located at the left back. ② Disassemble hex nut supply hose using wrench. ③ Disassemble Water Valve after disassembling the bracket and screw which secure the Water Valve. 	
POWER CORD	<ol style="list-style-type: none"> ① Disassemble Cover Grill, disassemble the circled 4 screws for mounting Housing Cover. ② Pull out the Housing of the Power Cord located at the top of the terminal block. ③ Disassemble (circled) 2 screws located at the top of the machine compartment. 	



6 Self Diagnosis

Case Output Terminal

(The Main PCB and the Case Output Terminals are connected with wire connectors.)

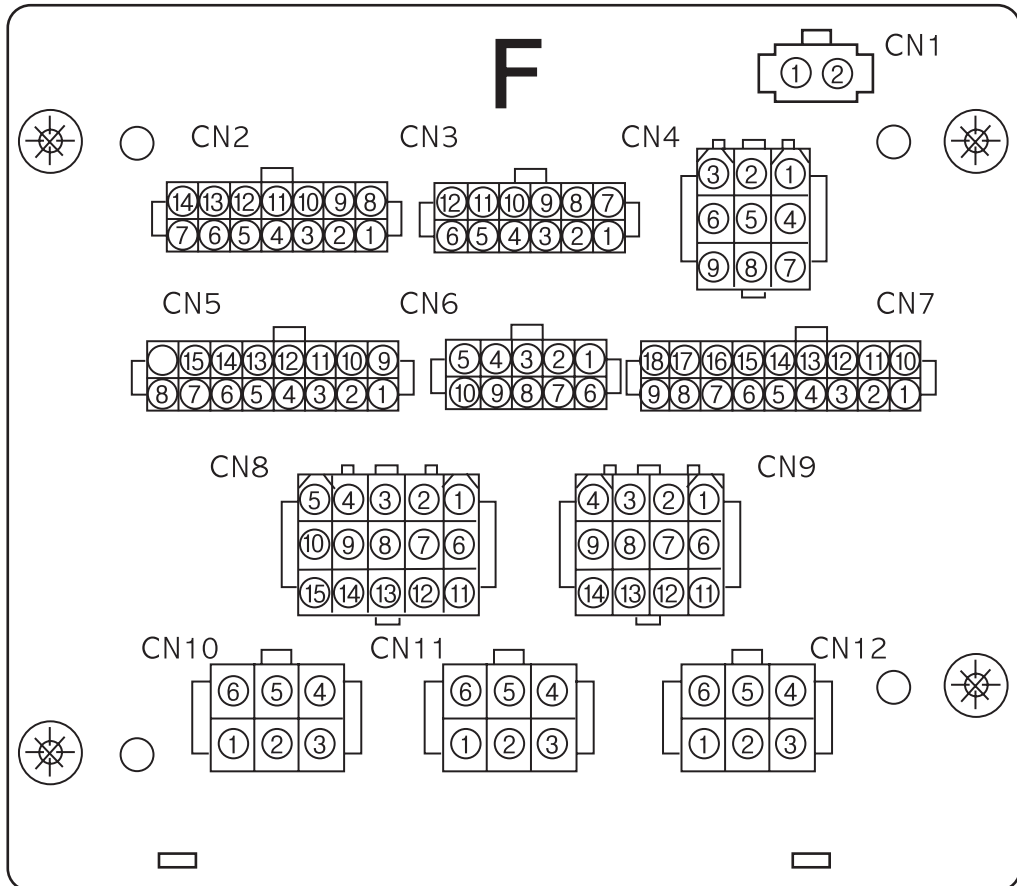

*Test the terminals on the PCB Case to check for voltage or operation related errors concerning QUEEN PJT. The terminal composition is shown in the diagram. If an error is found while testing the above terminals and the housing connectors, check the inside of the PCB Case.

⇒The following descriptions are based on the PCB Case.



5-1. How to run Test Mode

1. When the refrigerator is not turned on

Caution

There are AC115V and DC160V applied to the SMPS PCB terminals. So, take an extra care when repairing or measuring.

– When repairing the Main PCB, refer to Operation, Note and Assembly Diagram in this manual.

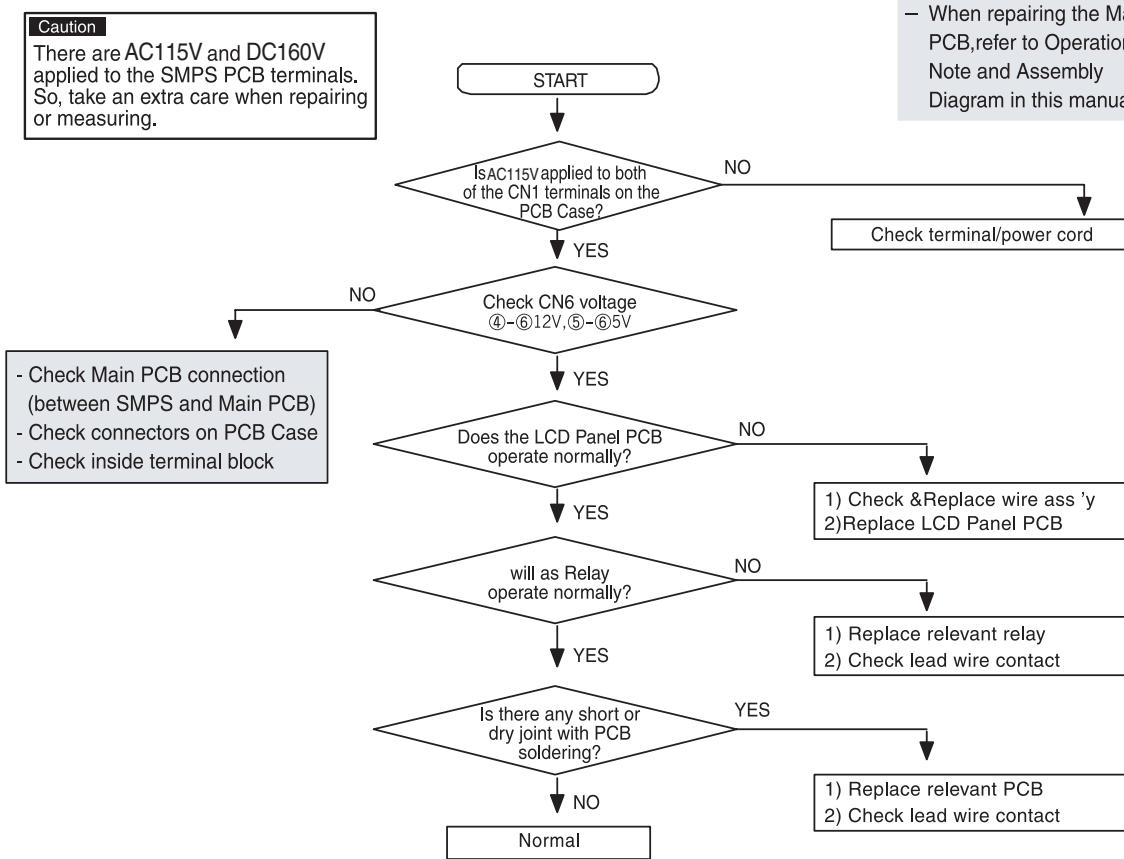



2. When the compressor does not operate

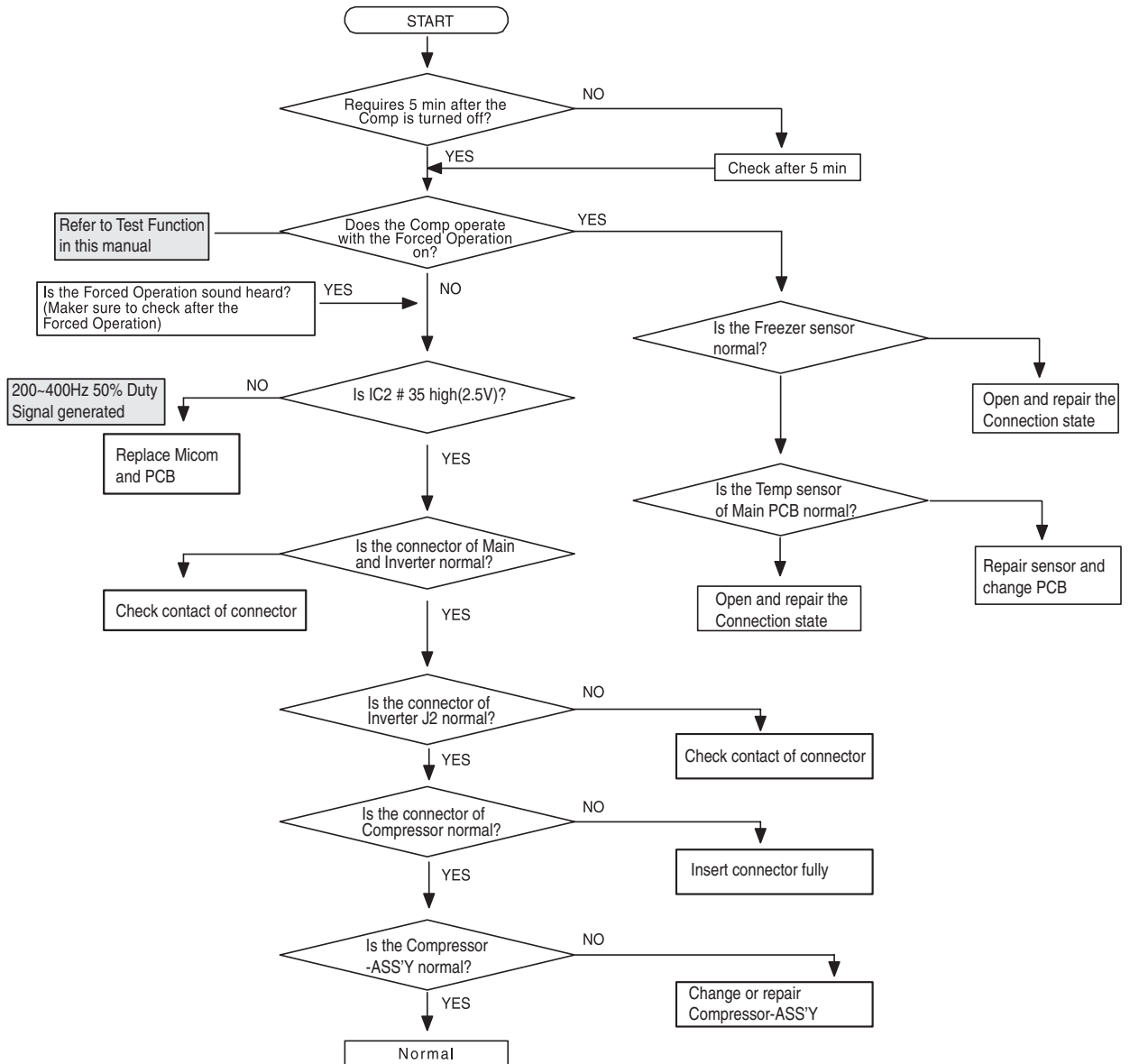



3. When Defrost does not operate

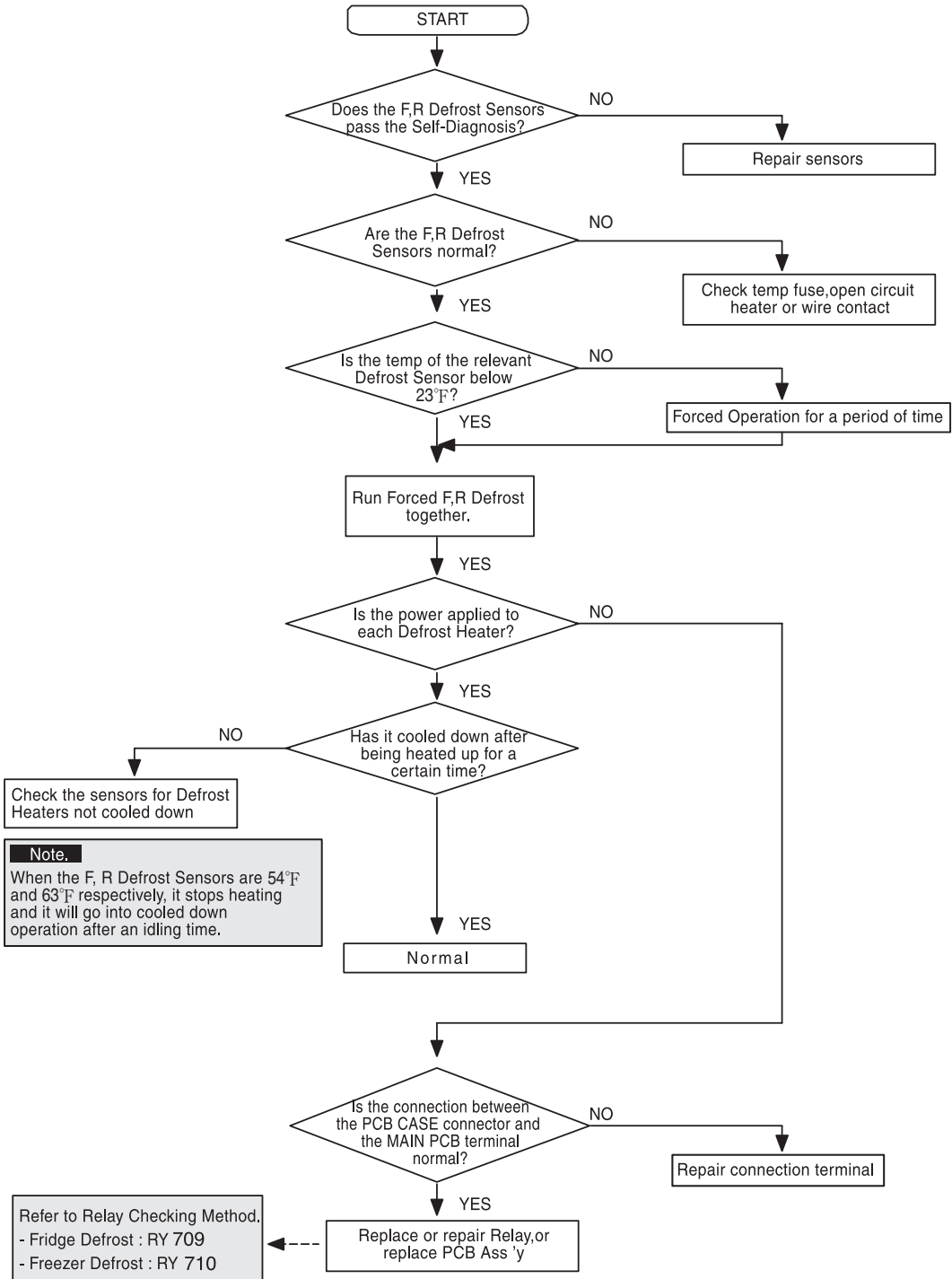



4. When error is detected by Self-Diagnosis (Sensor Error)

- When sensors is faulty, it will be shown on the display if there are faulty sensors detected from the initial power on, the refrigerator will not operate and blinks the relevant 7-SEG on the display.
- When sensors faulty during the operation, the refrigerator not stop operating. But, it could go into the Emergency Operation mode and will not carry on the normal cooling operation. Make sure to check becomes the Self-Diagnosis in this manual.

① When the Ambient Temp Sensor is faulty ((it is on the LCD Panel PCB)

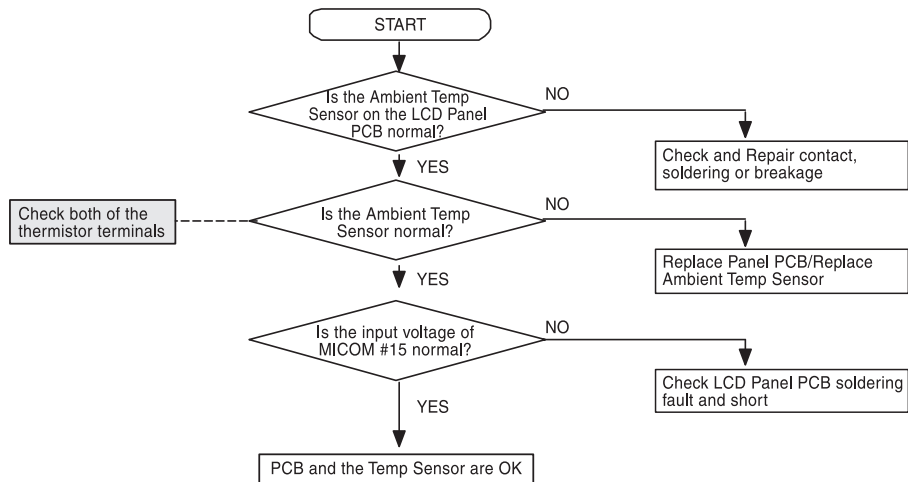

② When the Fridge Temp Sensor is faulty (Check other sensors by applying the following method)
 -. Check on the PCB Case

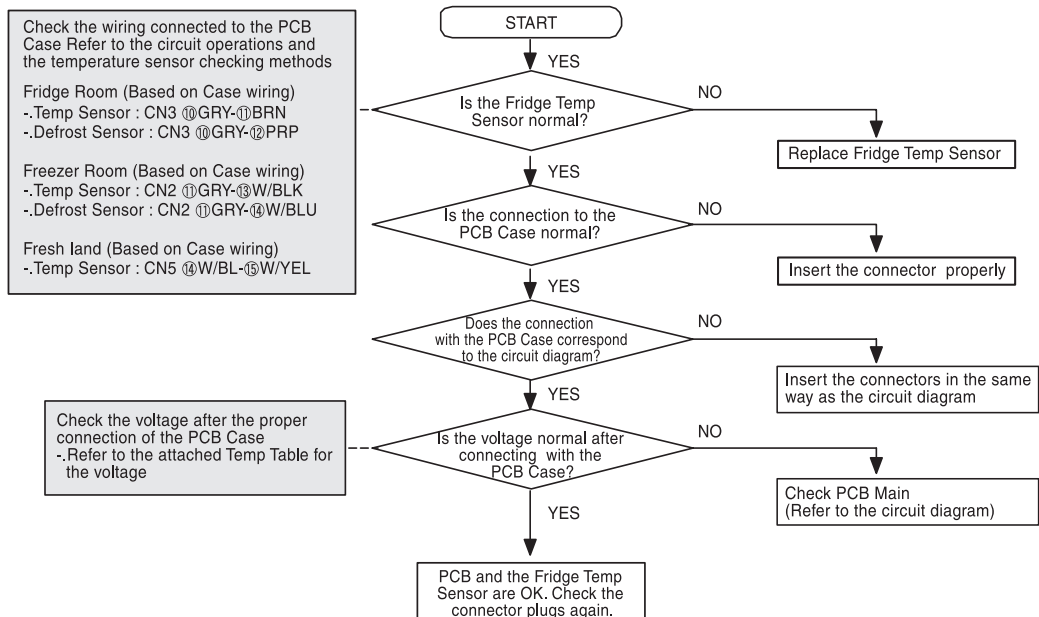



5. When the alarm sound will not turn off.

① When the Door Open sound stay's on

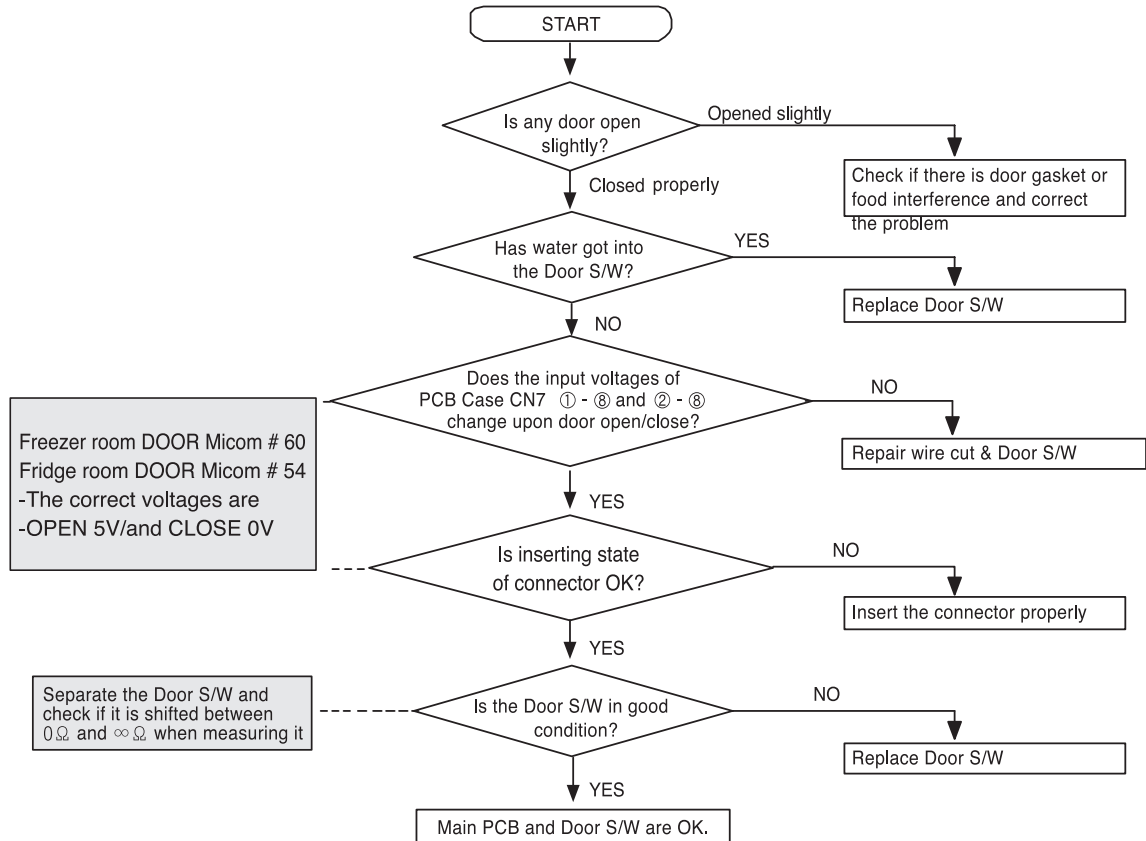

② When the Door Open sound will not turn off

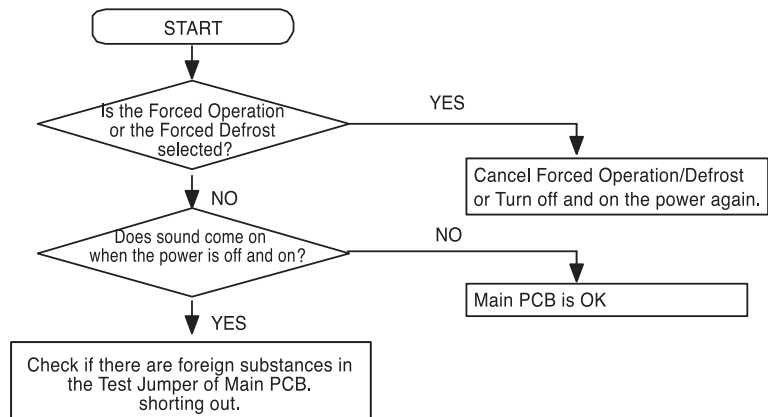



③ When there is no buzzer operation sound

- This model was installed buzzer to panel PCB. If there is no buzzer sound when does button action, forced operation and door opening, check break of buzzer, soldering badness etc..priority after disassemble panel PCB.
- Because panel PCB is consisted of SMD piece part, repair is difficult. It is recommended Assy replace in case of is not simplicity badness such as S/W press badness and coming off of surface among panel connection badness.

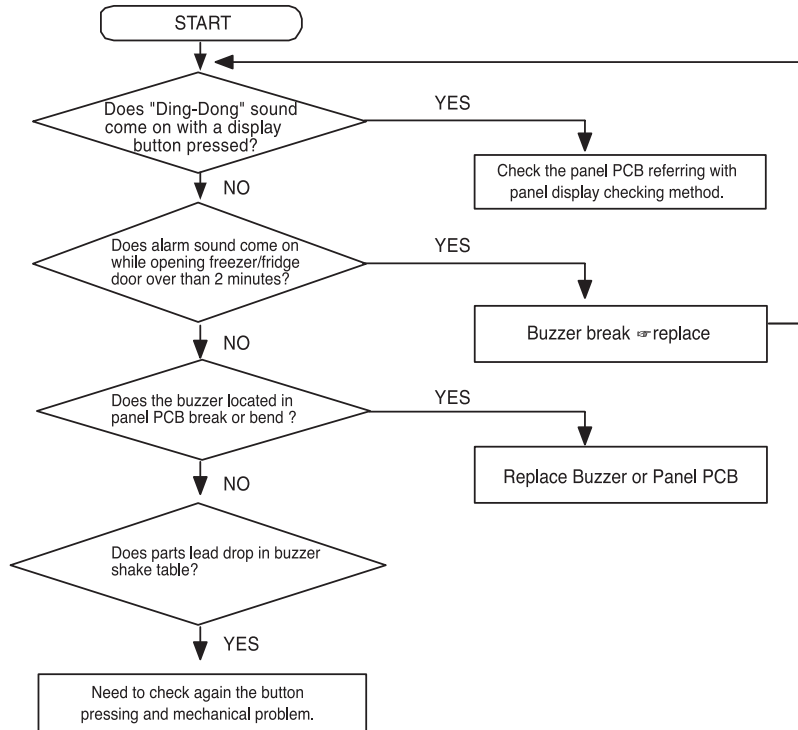



6. When there is fault in the display and communication error

When the entire LEDs keep on blinking

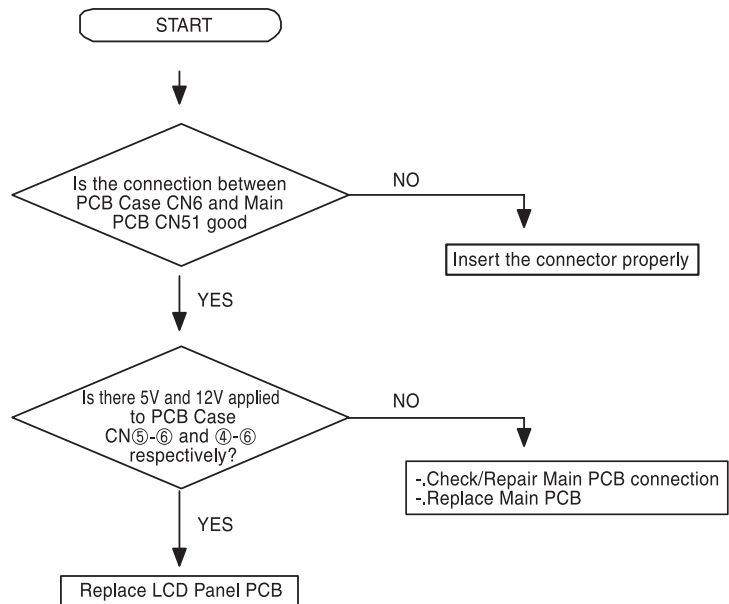

※ When a portion of LEDs are on the LCD Panel PCB will not light up, the connector pin might not be soldered properly or the LCD Panel is faulty, please repair or replace.



7. When Fan does not operate

- The BLDC Fan Motor is incorporated in this refrigerator. The BLDC motor operates on DC 7~12V.
- The F-Fan Motor operates together with the compressor. But, the Fresh Island function might prevent the F-Fan motor from operating. Also, when the door is opened and closed once with a high ambient temperature it operates after a one minute delay, make sure not to regard it as defect.
- Also, when the fridge compartment is open, both fan motors will stop(freezer + refrigerator).

※ NOTE
 F-FAN = Freezer
 R-FAN = Rfrigerator
 C-FAN = Circuit Fan(Condenser Fan)

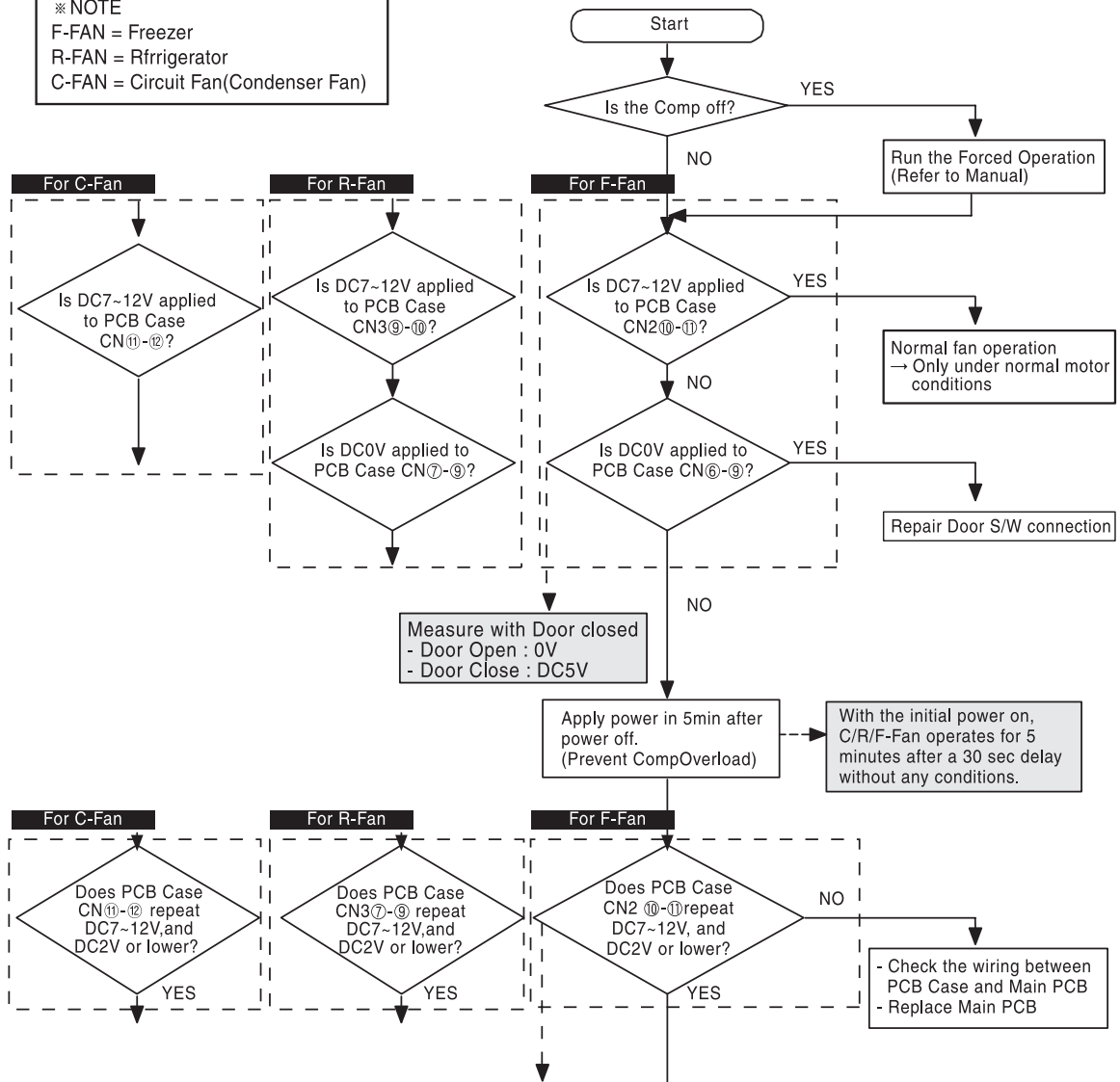

Note : Description based on PCB Case input
 Pulse signals generating when the motor runs are input to CN7 #10(C-Fan), CN2 #9(F-Fan)and CN3 #8(R-Fan). They are input to MICOM and when there is no input during motor operation, fans will go off and on again in 10 seconds. When there is no input, it will repeat the above 4 times. And, if the symptom continues, it will try again 10 minutes later. This function is incorporated in case there is motor restrictions by foreign substances such as ice built up around the motor.

- ◆ Possible Causes
- ① Fan Motor defect
 - ② Defective wire contact
 - ③ Check the motor pulse signals on Fan Motor operation (Refer to Fan Motor Driving Circuit)
 - ④ Operation defect due to motor restrictions



8. When Fresh Island does not operate properly (Only applied to Fresh Island Model)

① When the Fresh Island lamp does not light up

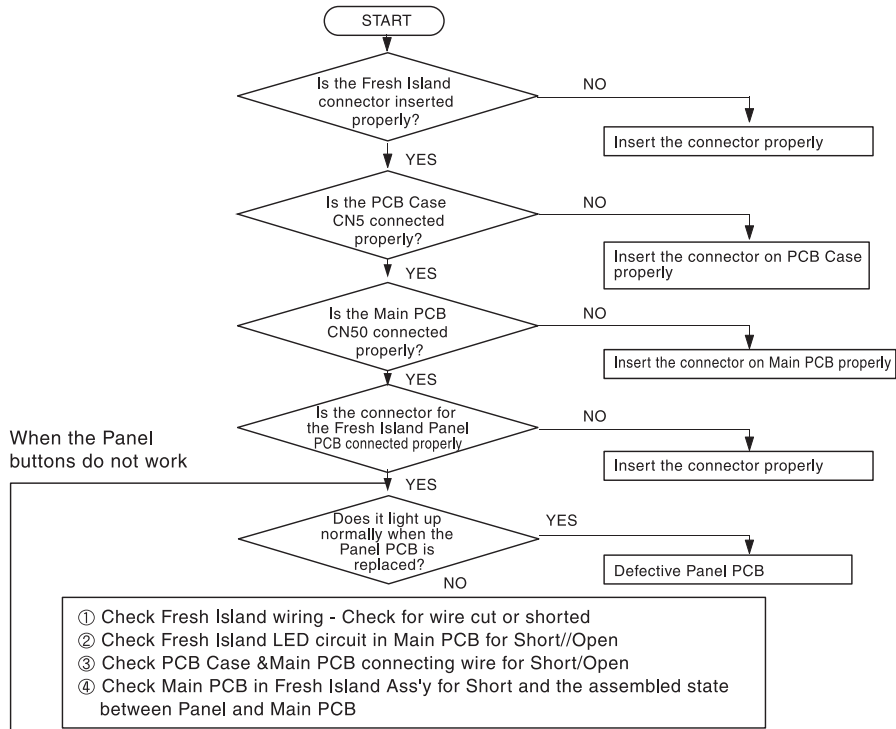

② When the Panel PCB button is not selected

※ When the fault is not corrected with the above method

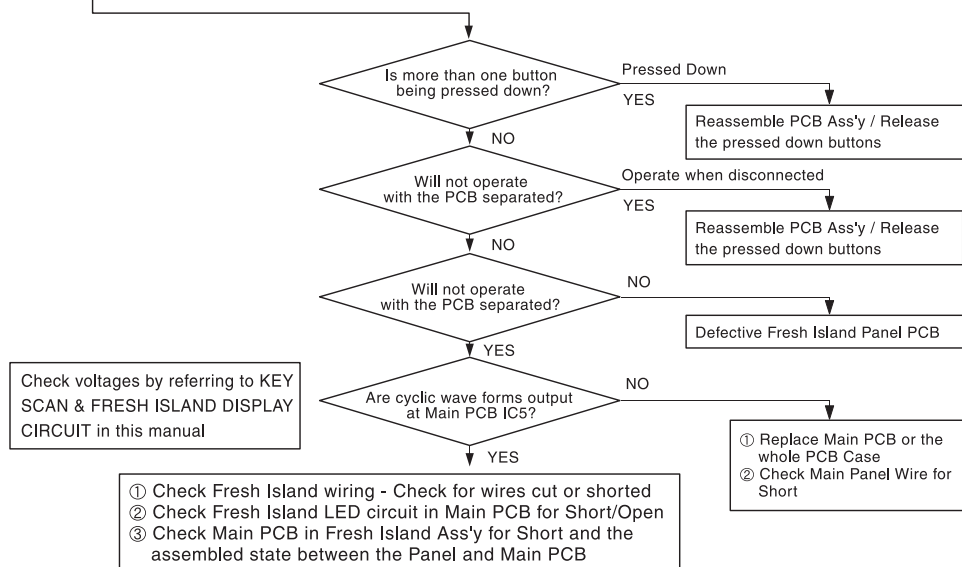



9. When F/R-Room Lamp does not light up

Caution

1. There is a possibility of being burn or electric shock, make sure to start repairing after a some time with the power turned off.
2. The lamp is a halogen lamp which generates high heat. CAUTION : NOT TO BURN YOURSELF.

Take off the Door S/W and measure its resistance at both of its terminals. It should be 0Ω and $\infty\Omega$ when the Door S/W is Close and Open respectively.
 → Measure its voltage when the Door S/W is Open.
 1) Only 0Ω is measured: Door S/W Short
 2) Only $\infty\Omega$ is measured: Door S/W Open
 3) When Door is Open : 0V
 4) When Door is Close : 5V

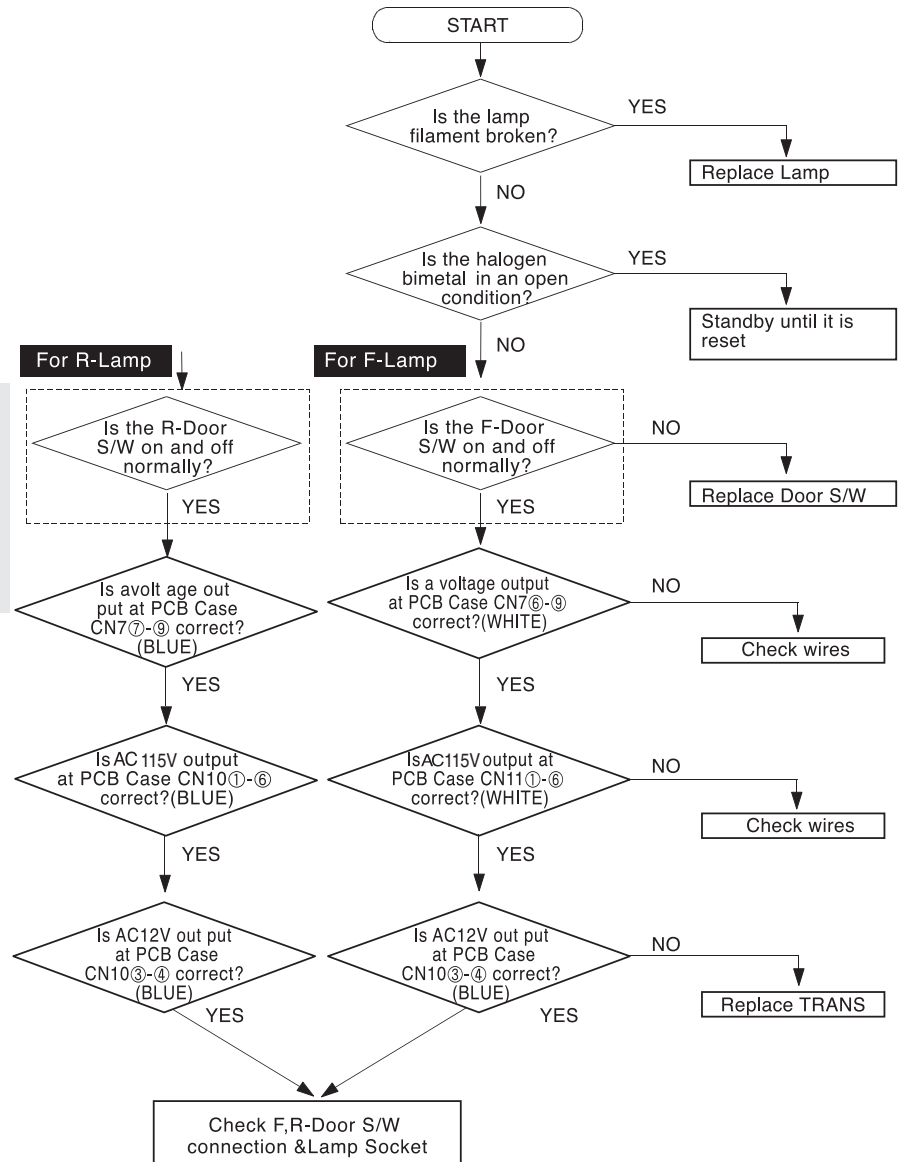

Note When the Door is open, the Door S/W becomes short and 0V is applied to MICOM which is considered as Door Open. Then, when 0V is detected for more than 2 minutes, it will send out a door open alarm sound every 2 minutes. When the Door S/W is defective, it could also send out the alarm sound every 2 minutes, take it into consideration when repairing.



10. When the Dispenser Lamp does not light up

- Caution**
1. There is a possibility of electric shock, make sure to start repairing after turning off the power.
 2. The lamp is a incandescent bulb which generates high heat, make sure not to get burn.

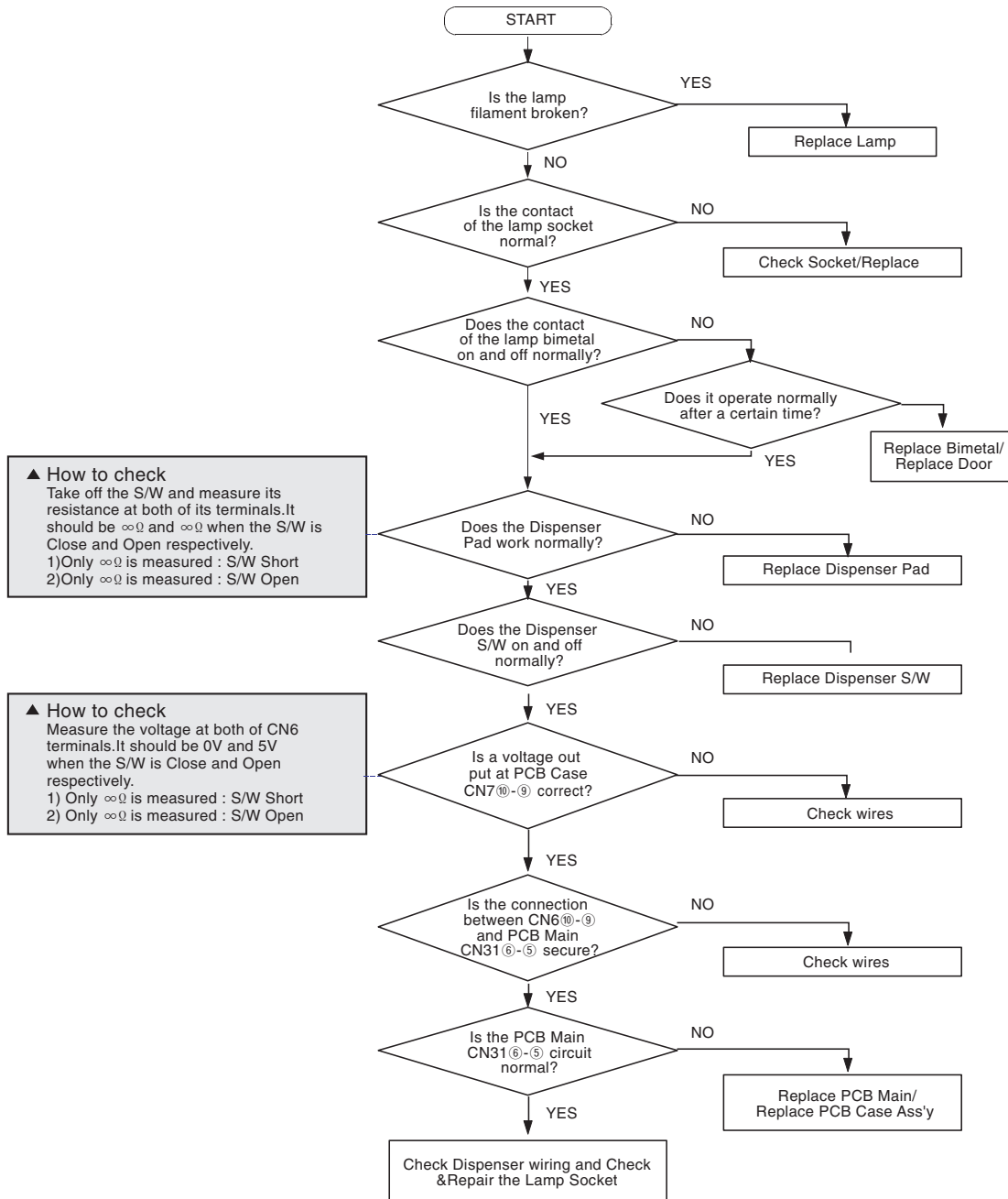



11. When Cover Ice Route Motor (Geared Motor) does not operate properly Caution

CAUTION

1. There is a possibility of electric shock, make sure to start repairing after turning off the power.
2. Take an extra care when disassembling the Cover Ice Motor because springs inside could pop up.
3. When there is no signal from the Motor S/W, the Motor keeps on operating.

① When the Cover Ice Motor does not operate

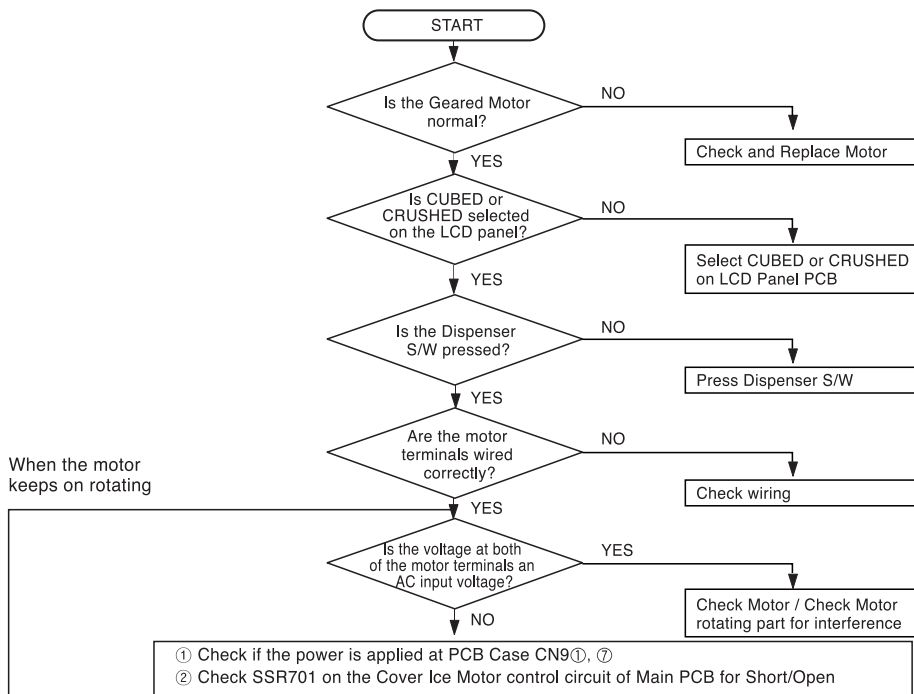

When the motor keeps on rotating

← ② When the Cove Ice Motor keeps on rotating

※ When the fault is not corrected with the above method

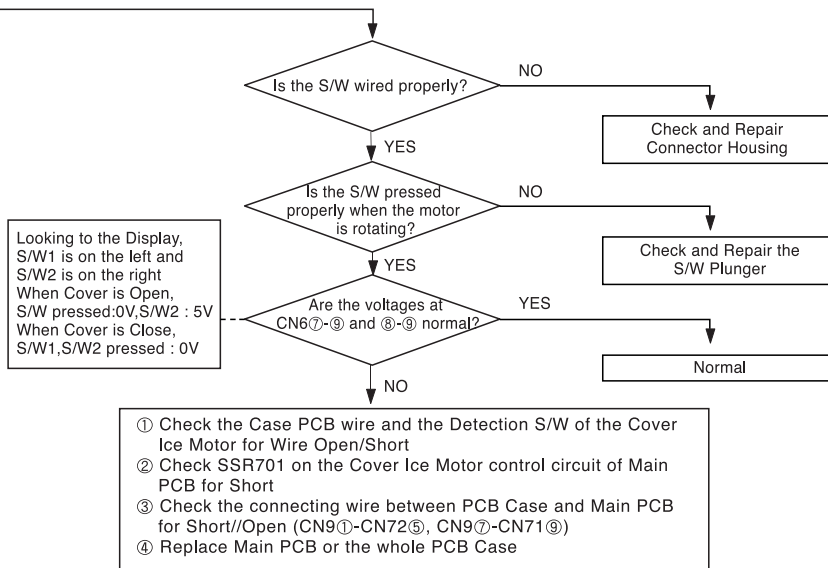

Looking to the Display, S/W1 is on the left and S/W2 is on the right
When Cover is Open, S/W pressed: 0V, S/W2 : 5V
When Cover is Close, S/W1, S/W2 pressed : 0V



12. When Water Valve does not operate

Check in advance

1. Because water is supplied to the water valve directly, make sure to turn off the tap before disassembling.
2. Power is always applied to the wiring, so make sure not to be struck by electricity.

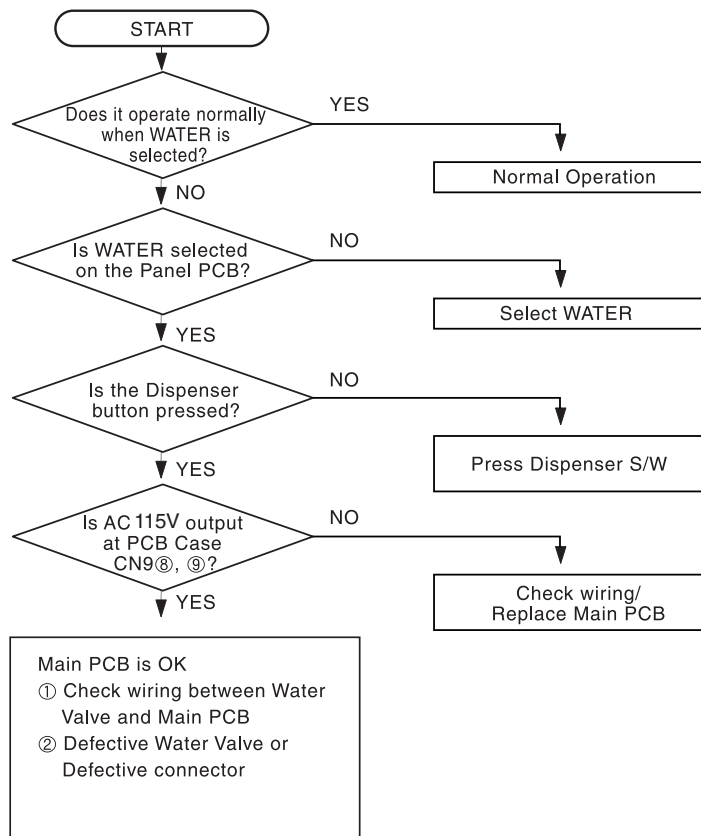



13. When CRUSHED or CUBED does not operate properly

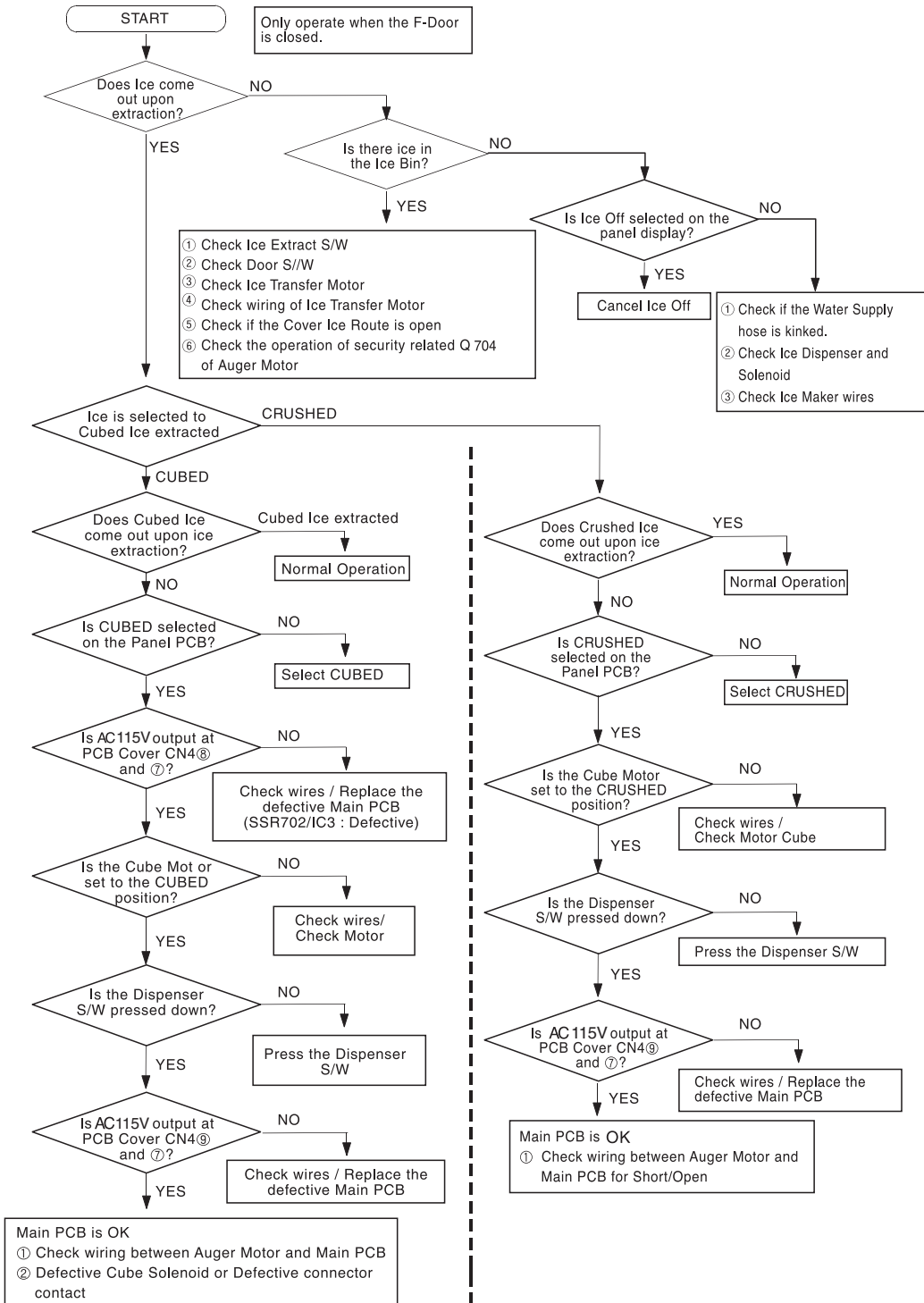



8 BLOCK DIAGRAM

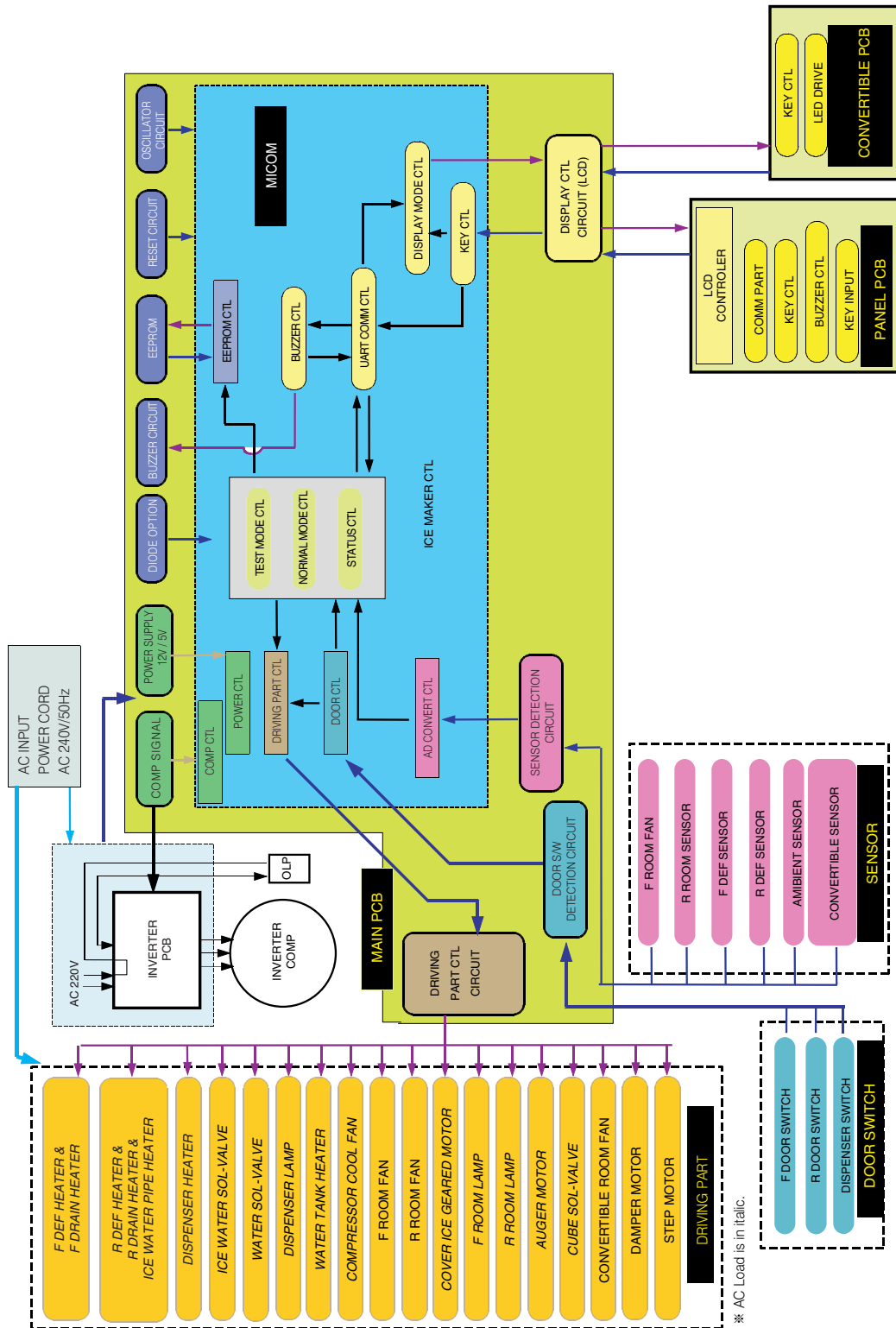



9 WIRING DIAGRAM

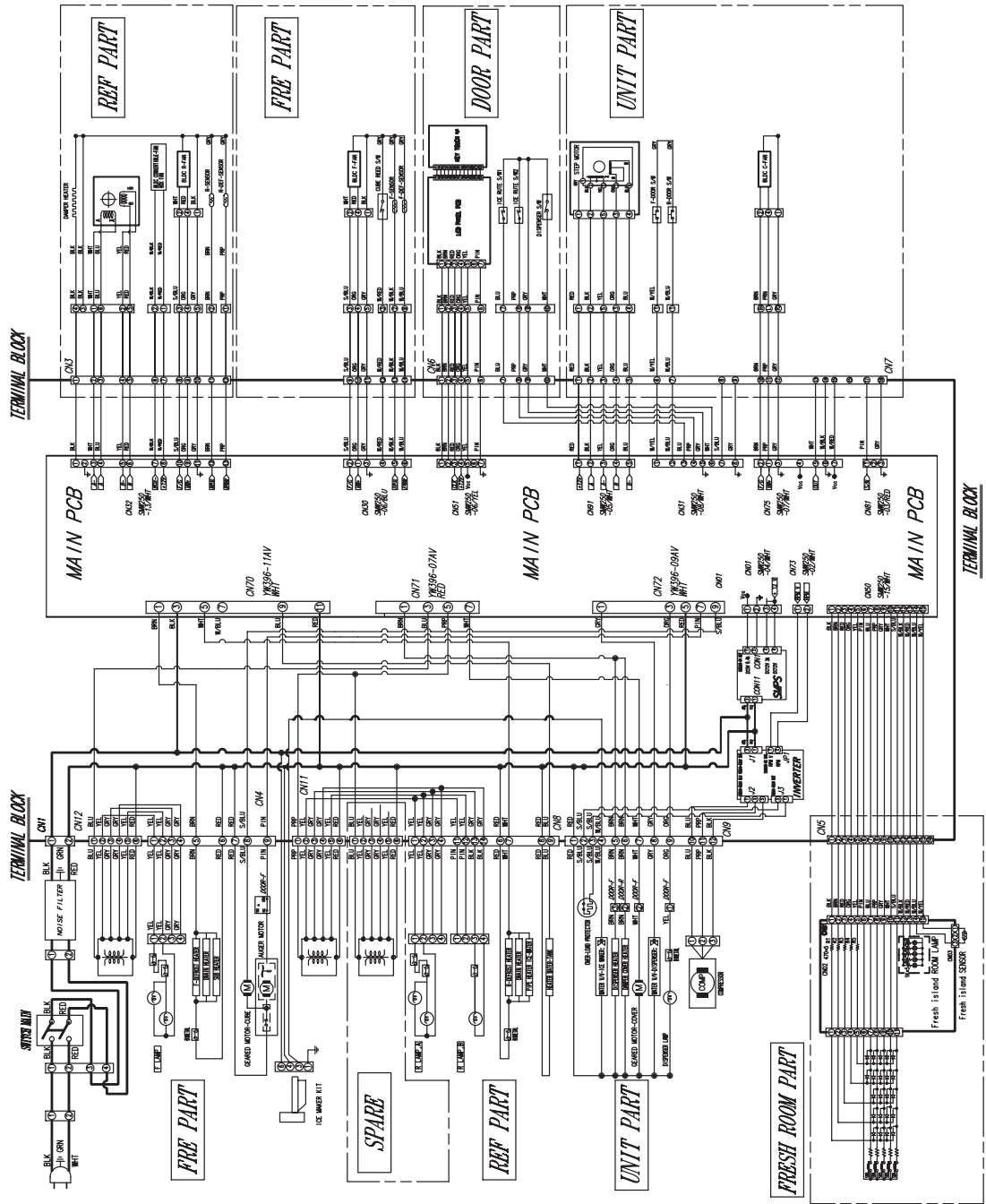



10 PARTS DESCRIPTION

10-1. PARTS DESCRIPTION (MAIN)

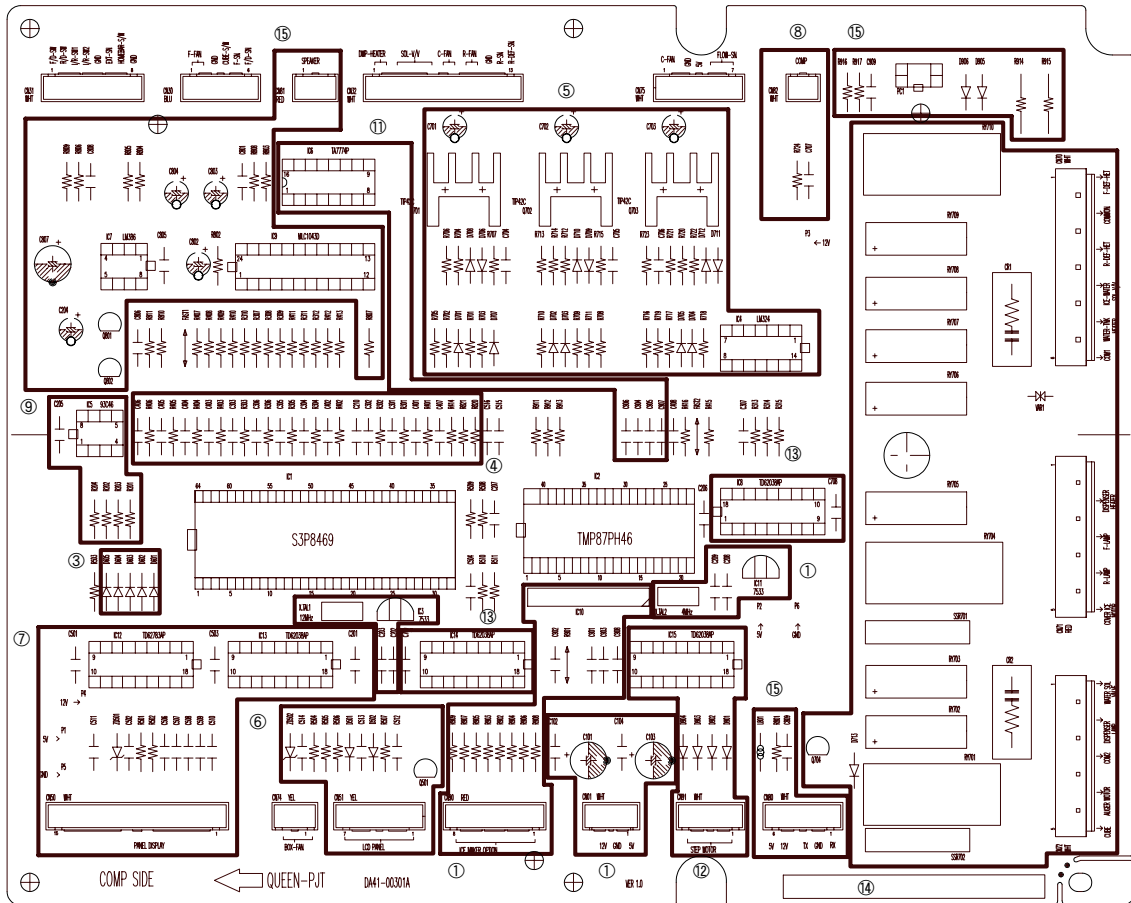

- ① Power
 - Power supply for the product from SMPS
- ② MICOM Periphery Circuit
 - Oscillator & Reset circuit for MICOM controlling
- ③ Option Selecting Section
- ④ Sensors & Switch Periphery Circuit
 - It transmits sensor and S/W on/off signals to MICOM after eliminating noises.
- ⑤ Fan Driving Circuit
 - Fridge, Freezer & Machine Compartment Fan Motor Driving Circuit
- ⑥ LCD Panel Communication Circuit
 - Communication Circuit between Main and LCD Panel
- ⑦ Convertible Room Control Circuit
 - Temp Display & Function Selection of Convertible Room
- ⑧ Inverter Compressor Control Circuit
 - Comp RPM signal output according to load conditions
- ⑨ EEPROM
 - Storage of various data
- ⑩ Ice Maker Driving Circuit
 - Circuit for Ice Maker operation
- ⑪ Damper Driving Circuit
 - Damper for Temp Control of Convertible Room
- ⑫ Step Motor Driving Circuit
 - Valve driving for the controlling of freezer/fridge refrigerant flow
- ⑬ Driver IC
 - Driver IC for Relay
- ⑭ AC Load Control
 - Relay, SSR, Surge Killer



10-2. PARTS DESCRIPTION (SMPS & INVERTER)

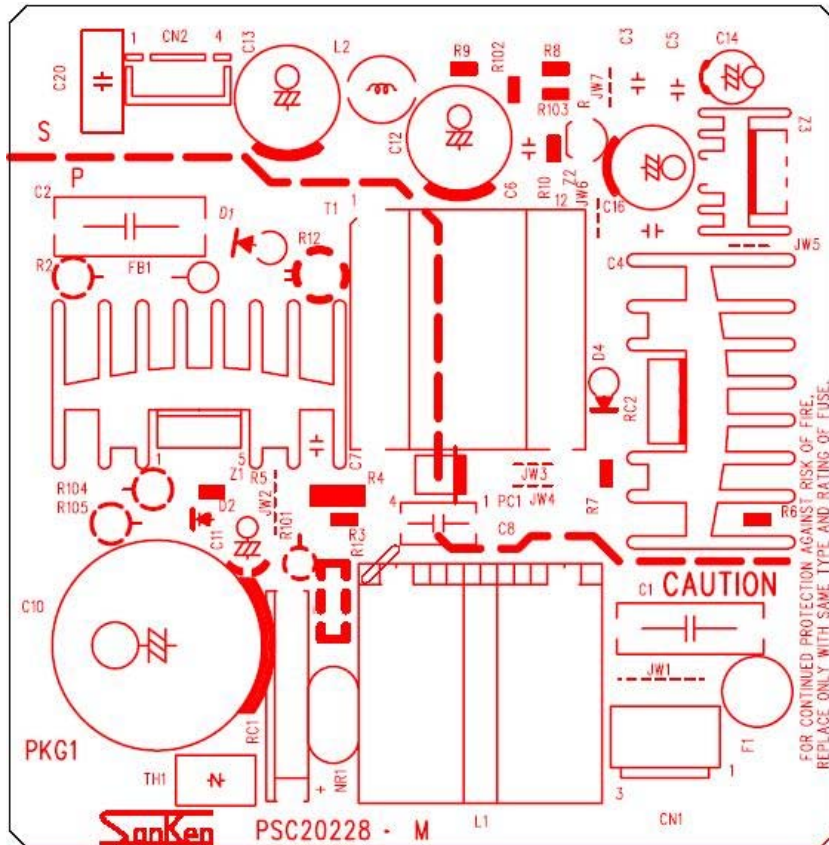

Convert AC inputs into DC voltages (5V, 12V) for the refrigerator control.



11 CIRCUIT DIAGRAM

● CIRCUIT DIAGRAM (MAIN)

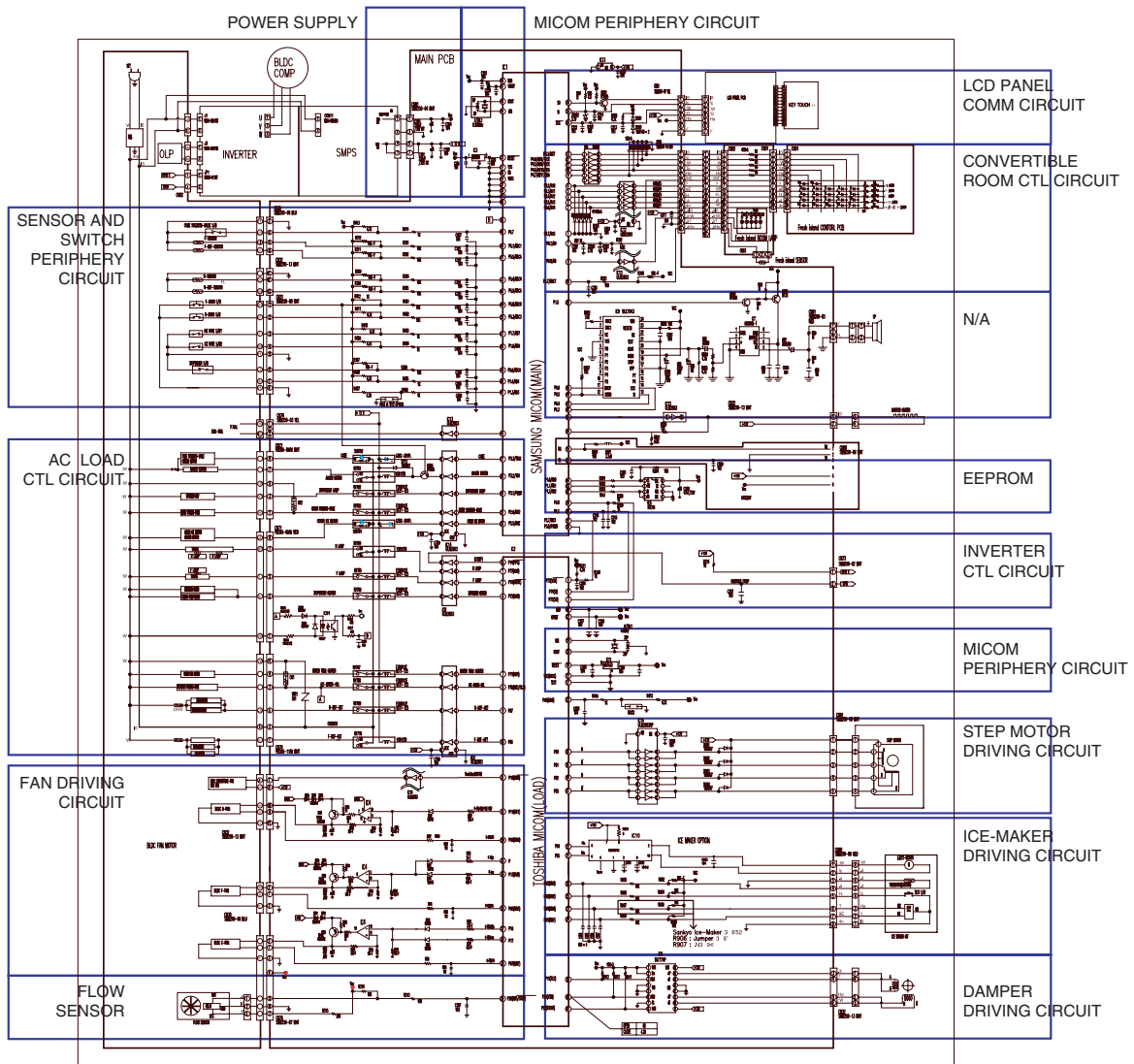



12 CIRCUIT DESCRIPTION

12-1. CONNECTOR ARRANGEMENT DESCRIPTION (MAIN)

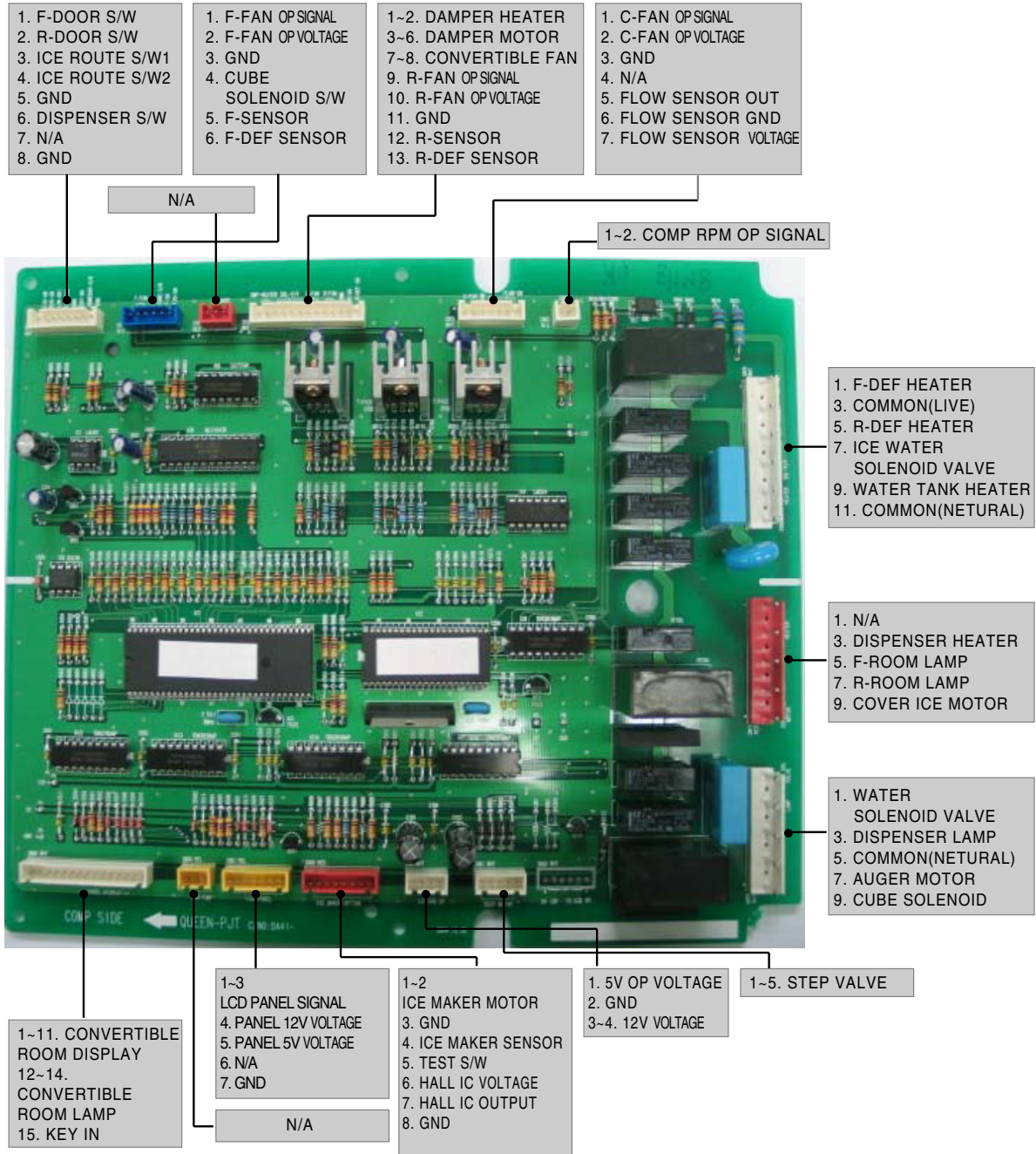



12-2. CONNECTOR ARRANGEMENT DESCRIPTION (SMPS & INVERTER)

