

# DACOR

## *Training Bulletin* *New Model Introduction*

*DACOR Service Training*

***Wine Chiller EWC240***

***Beverage Center EBC240***

The installation of this product includes an on-site handle. Installation is not required and door reversing does not require drilling. The leveling legs are factory-installed and need only to be adjusted on-site. The wood fronts on the wire racks can be stained to match the cabinetry. Please read the installation instructions for all pertinent installation information.

The nomenclature tag is located on the interior ceiling of the unit. The Mini Manual is taped to the right front corner of the unit behind the toekick.

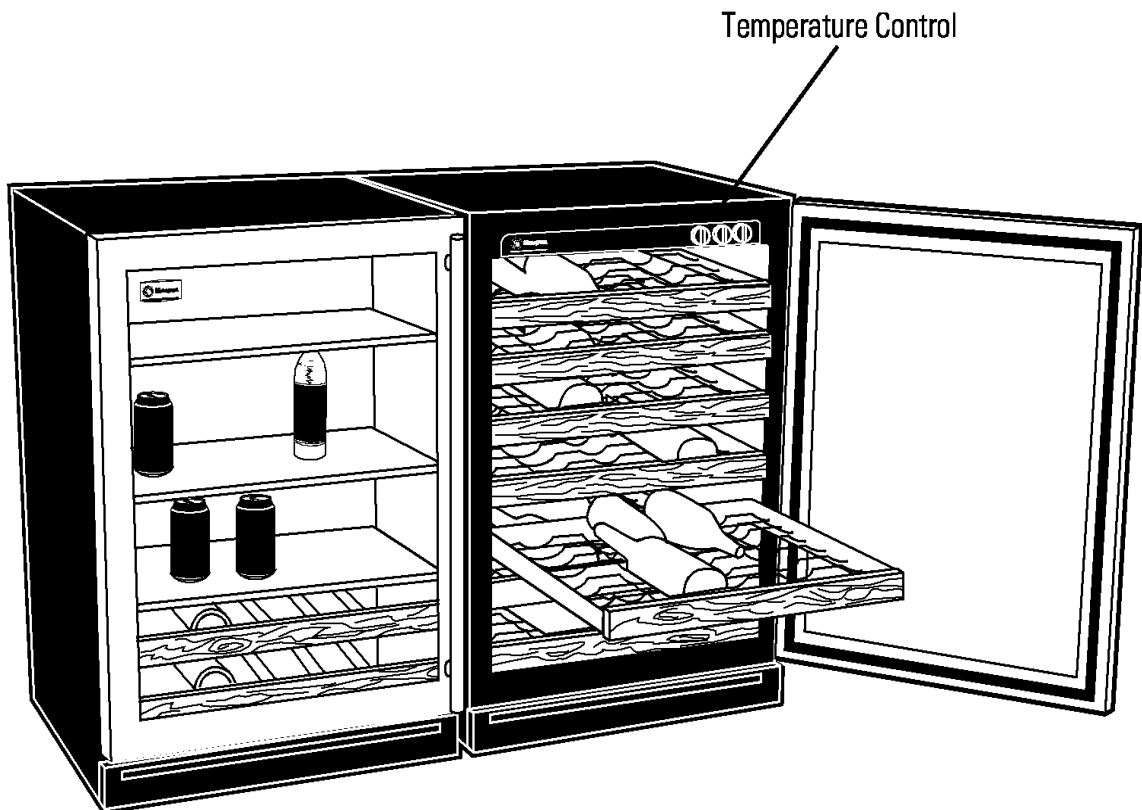

**Side-by-Side Installation**

## Wine Chiller Features

- Total Capacity - 57 Wine Bottles
- 7 Full-Width Slide-Out Racks with Wood Fronts on Full-Extension Slides
- Upfront, Adjustable Temperature Control
- Interior Light with Automatic or Manual Setting
- Tinted Glass Door with Stainless Trim
- Tubular Stainless Steel Handle
- Reversible Door Swing
- Built-In or Free-Standing Installation Options
- Black Case and Black Toekick

## Beverage Center Features

- Total Capacity - 133 Beverage Cans, 12 Wine Bottles
- 2 Full-Width Slide-Out Racks with Wood Fronts on Full-Extension Slides
- 3 Full-Width Glass Slide-Out Shelves on Full-Extension Slides
- Upfront, Adjustable Temperature Control
- Interior Light with Automatic or Manual Setting
- Tinted Glass Door with Stainless Trim
- Tubular Stainless Steel Handle
- Reversible Door Swing
- Built-In or Free-Standing Installation Options
- Black Case and Black Toekick

## Installation Considerations

The Wine Chiller/ Beverage Center can be installed either as a built-in or a free-standing unit. The unit may be closed in on the top and three sides as long as the front is unobstructed for air circulation and allows proper access to the door.

A 120 volt 60 Hz, 15 or 20 amp power supply is required. A dedicated, properly grounded, branch circuit or circuit breaker is recommended.

Do not install the unit where the temperature will go below 55°F (13°C) or above 90°F (32°C).

Do not install where it will be subject to direct sunlight, heat or moisture.

## Interior Light Switch

The light switch is located in the upper right front corner of the unit. When the switch is in the OFF position, the interior light comes on automatically only when the door is opened. When the switch is in the ON position the light will stay on whether or not the door is open.

## Wood Fronts on Racks

The wood drawer fronts on the racks of the Wine Chiller/ Beverage Center may be stained to match the surrounding cabinets. The tinted glass will make the stained wood appear darker, so a true color match can only be seen when the door is open.

## Full-Extension Slides

The full-extension slides on the racks and shelves in the Wine Chiller and Beverage Center allow the racks/shelves to be pulled out fully for easy addition and

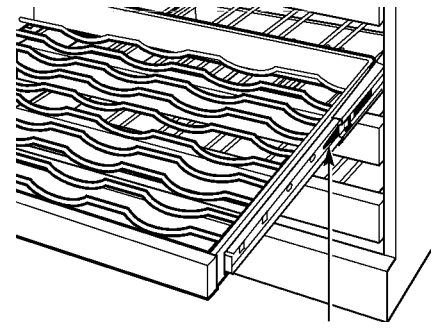

removal. Any of the racks/shelves can be removed to store larger items. To remove the racks/shelves: pull the rack/shelf out to the STOP position.

Push the tab on the right rack guide

Tab (push tab down on right rack guide, pull tab up on left rack guide)

down while pulling the tab on the left

guide up, and pull the rack out. To

replace, insert the sides of the rack/shelf back into the guides and push until the tabs snap into place. Make certain the tabs on the rack/shelf are fully engaged before loading.

## Temperature Control

The temperature control on the new Wine Chiller/Beverage Center is located in the right front corner of the unit. Both the Wine Chiller and the Beverage Center deliver colder temperatures at the bottom of the interior compartment and warmer temperatures at the top of the compartment. Normal operating temperatures for the Wine Chiller range from mid 40°F to mid 60°F. Normal operating temperatures for the Beverage Center shelves range from low 40°F to upper 40°F, while the lower racks range from mid 30°F to mid 40°F. The temperature control also has an "Off" position when the unit is not in use. To set the control, turn it to the midpoint setting. Once the unit has been turned on, allow at least 24 hours before making any adjustments. The cold control provides total 12°F adjustability nominal. As with any refrigeration product, there is a slight temperature variance at different locations within the cabinet.

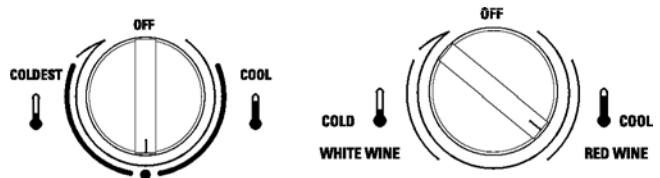

## Evaporator and Drain

The evaporator and the drain are located on the rear wall of the unit. These are easily accessible for service and cleaning.

## Factory-Installed Handle and Leveling Legs

The door handle and the leveling legs on the Dacor Wine Chiller and Beverage Center are installed during the production of the units. On-site installation is not required for these parts. After installation the unit should be leveled using the leveling legs and the directions found in the Installation Instructions.

## Door Reversibility

The door swing of these units can be reversed. The door swing should be changed before installation. Refer to the Installation Instructions for further information on the procedure.



## Control Panel

The cold control and light switch are easily replaced by first removing enough shelves to expose the capillary bulb retainer clip.

Remove the retainer clip to expose the end of the capillary. The thermostat capillary is routed through a plastic sleeve. Carefully pull the capillary through the sleeve to remove. Remove the two Phillips screws securing the control panel above. Slide the control panel forward until the cold control electrical connector plug is exposed. When reinstalling capillary, make certain the bulb is captured behind the retaining clip.

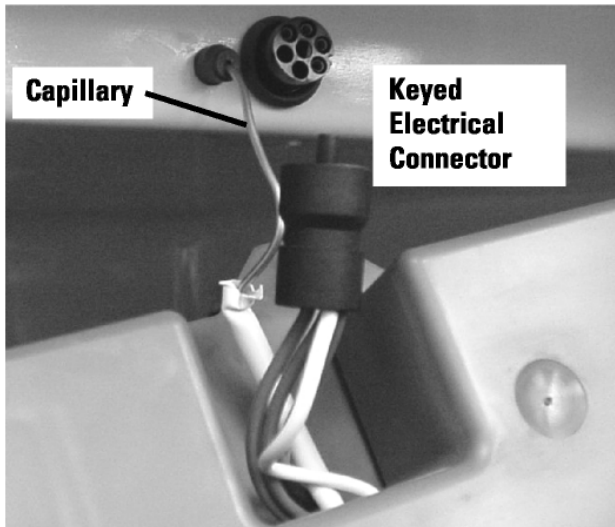

When reinstalling, note the longer screws hold the retaining clip while the shorter screws secure the control panel.

## Evaporator

The evaporator is foamed into the interior back wall of the unit and is not serviceable.

## Condenser Fan

To access the compressor, relay, overload, run capacitor, condenser and condenser fan, remove the machine compartment cover, held by 3 Phillips screws. The condenser fan is replaced by first removing two Phillips screws and plastic bushings at the base of condenser fan bracket.

Slide the bracket, motor, and fan assembly to the left and out of the unit. Fan wiring is disconnected at terminals inside compressor cover. When reinstalling new fan motor, first remove white plastic clips to permit black rubber bushings to be fully seated.

## Terminal Block

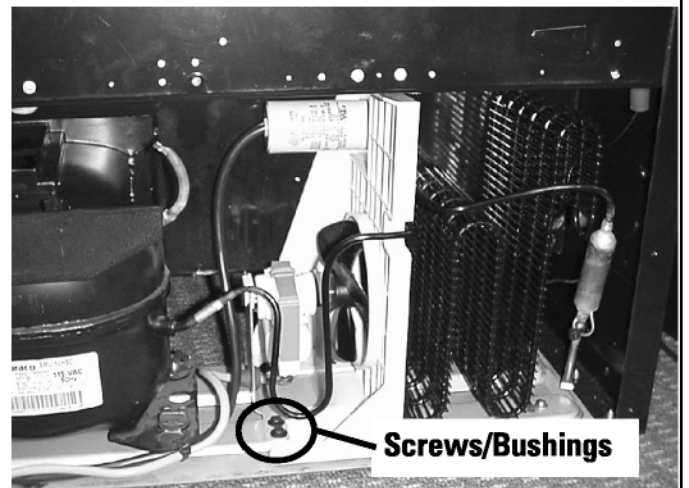
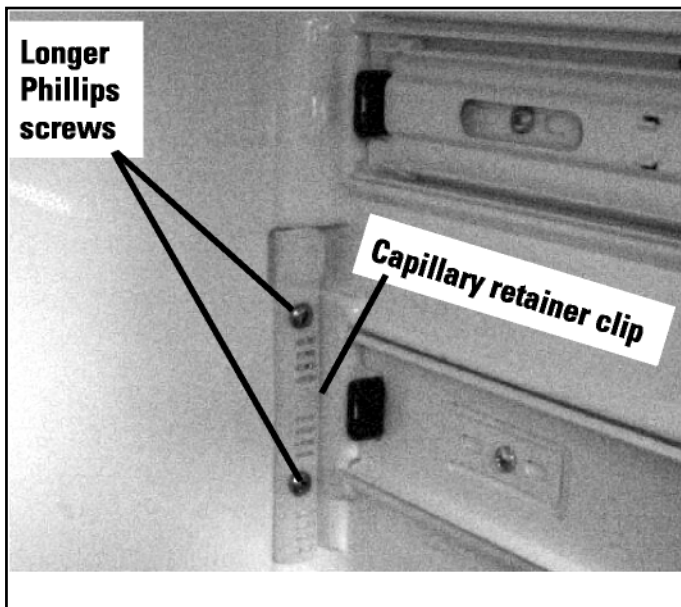
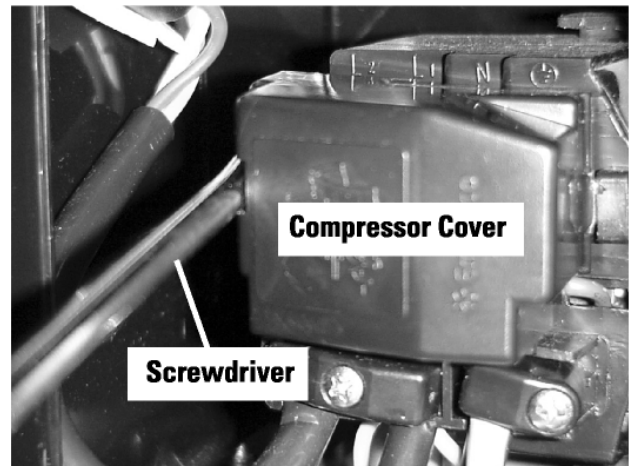

# Wiring and Schematic

