

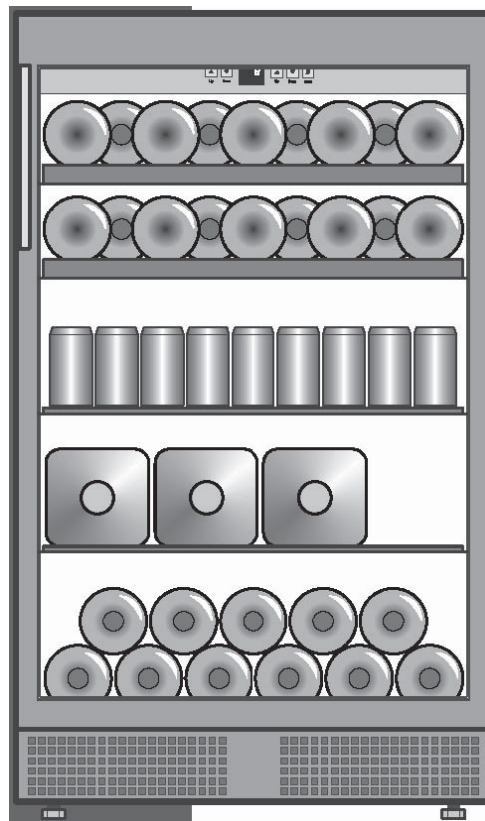

---

# Service Manual Beverage Cooler

*Cover Model:*  
EF24



The Life of the Kitchen.®

---

Please read all safety information before installing, operating, or repairing this appliance.

***dacor***<sup>®</sup>

The Life of the Kitchen.<sup>®</sup>

---

# Service Manual Beverage Cooler

***Cover Model:***

*EF24*

<b>Section 1 - Operating and Control Elements .....</b>	<b>1-1</b>
<b>Section 2 - Functions at a Glance .....</b>	<b>2-1</b>
<b>Section 3 - Description of the Appliance (In Brief) ...</b>	<b>3-1</b>
Schematic Diagram (side view) .....	3-2
Interior View of the Appliance with (e.g. WKUes 1753).....	3-3
<b>Section 4 - Control and Functional Components .....</b>	<b>4-1</b>
<b>Section 5 - Refrigeration Circuit .....</b>	<b>5-1</b>
<b>Section 6 - Special Features .....</b>	<b>6-1</b>
Plinth for Ventilation and Air Extraction .....	6-1
Fan Function .....	6-1
<b>Section 7 - Assembly Instructions .....</b>	<b>7-1</b>
Disassembling the Electronic Control System .....	7-1
Detaching Light Housing.....	7-2
Disassembling the Sensors .....	7-2
Disassembling the Fan .....	7-3
<b>Section 8 - Technical Data .....</b>	<b>8-1</b>
<b>Section 9 - Service Menu .....</b>	<b>9-1</b>
Demo Mode .....	9-1
Service Mode .....	9-1
Sensor Test (temperature display) and Door	
Contact Test .....	9-2
<b>Section 10 - Table of Error Codes .....</b>	<b>10-1</b>
<b>Section 11 - Customer Menu .....</b>	<b>11-1</b>
Child Proofing .....	11-1
Display Brightness .....	11-1
Changing the Unit for the Temperature Display	
(°F -> °C) .....	11-1

## Section 1 - Operating and Control Elements

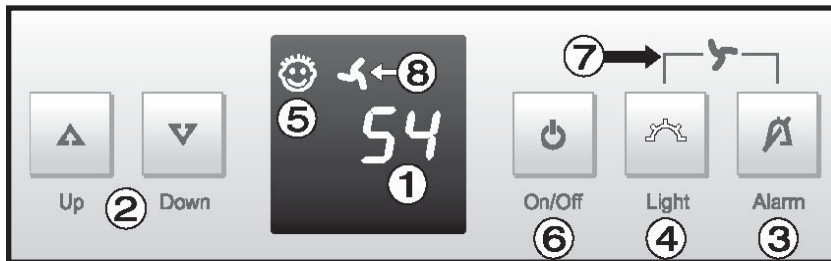

1. Temperature display
2. Temperature setting buttons
3. Alarm OFF button
4. ON/OFF button, interior light
5. Child proofing display
6. ON/OFF button
7. Fan operation
8. Display for ventilation ON

## Section 2 - Functions at a Glance

<b>Control</b>	Electronic control system
<b>Temperature display</b>	Digital
<b>Temperature alarm</b>	Visual and audible
<b>Door alarm</b>	Audible
<b>Cooling</b>	Dynamic
<b>Defrosting</b>	Automatic
<b>Lighting</b>	Fluorescent tube, permanent or when door is open
<b>Refrigerating system</b>	Standard compressor
<b>Climate rating</b>	SN – ST: +50°F to +100°F (+10°C to +38°C)
<b>Self test</b>	Start by button combination
<b>Glass door</b>	Interchangeable door hinges, k value 1.1
<b>Activated charcoal filter</b>	Can be changed from the inside
<b>Suitable for installation under worktop</b>	Dynamic ventilation and air extraction in base
<b>Height-adjustable</b>	Height can be varied from 858 mm to 909 mm by adjustable feet

### Section 3 - Description of the Appliance (In Brief)

- The temperature can be set **between +37°F and +68°F (+3 and +20°C)**.
- The appliance has a compressor and a freely suspended rear wall evaporator.
- A fan is fitted in the interior, above the evaporator. It takes in air from the front and blows it downwards via the evaporator. Comparatively constant temperatures are attained by this means.
- Defrosting is automatic.
- On the ceiling is the **interior light**.
- Unit ventilates and extracts air through the base. The base is closed at either side and at the rear.

## Schematic Diagram (side view)

---

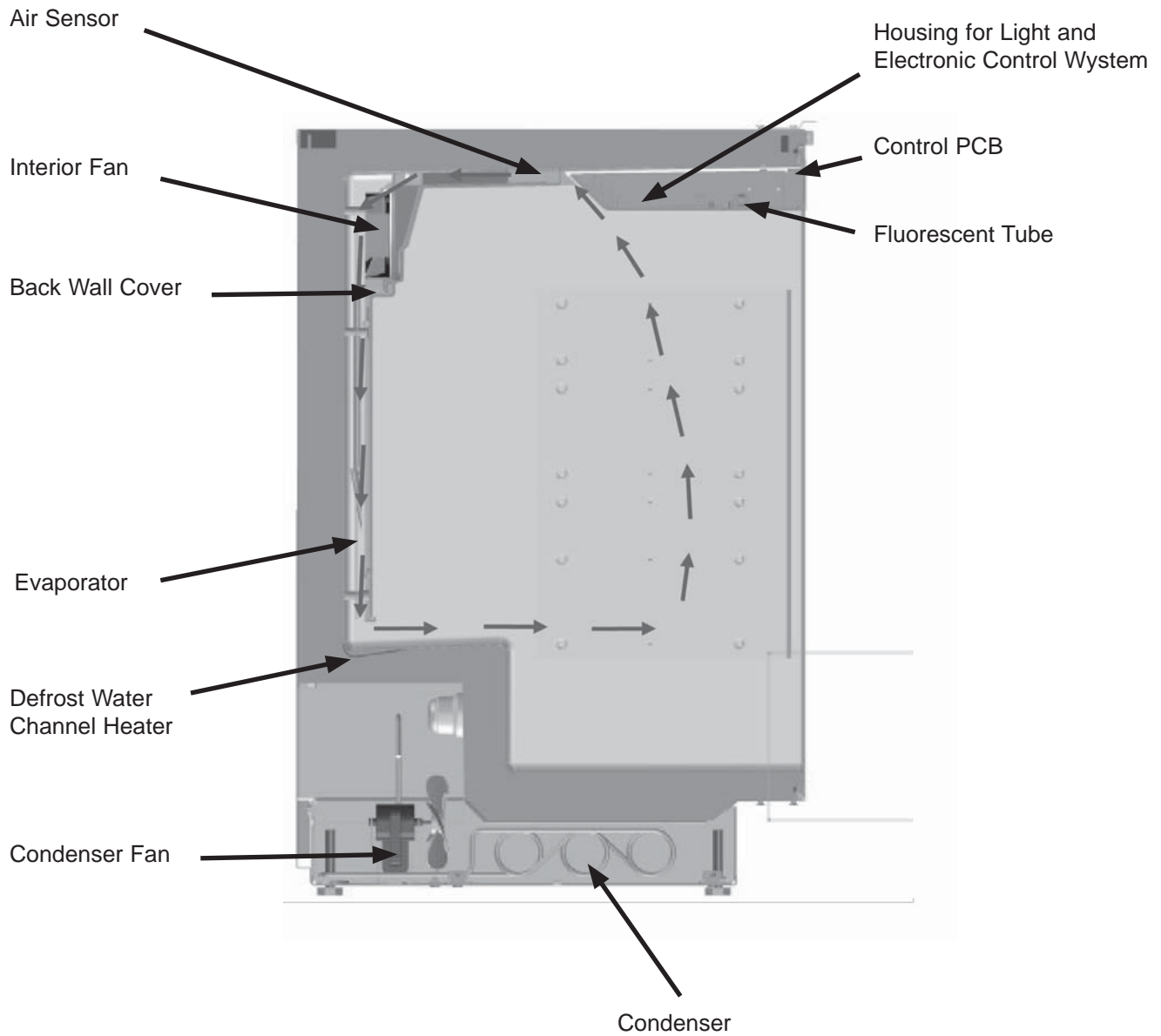

## **SECTION 3 - DESCRIPTION OF THE APPLIANCE (IN BRIEF)**

### **Interior View of the Appliance with (e.g. WKUes 1753)**

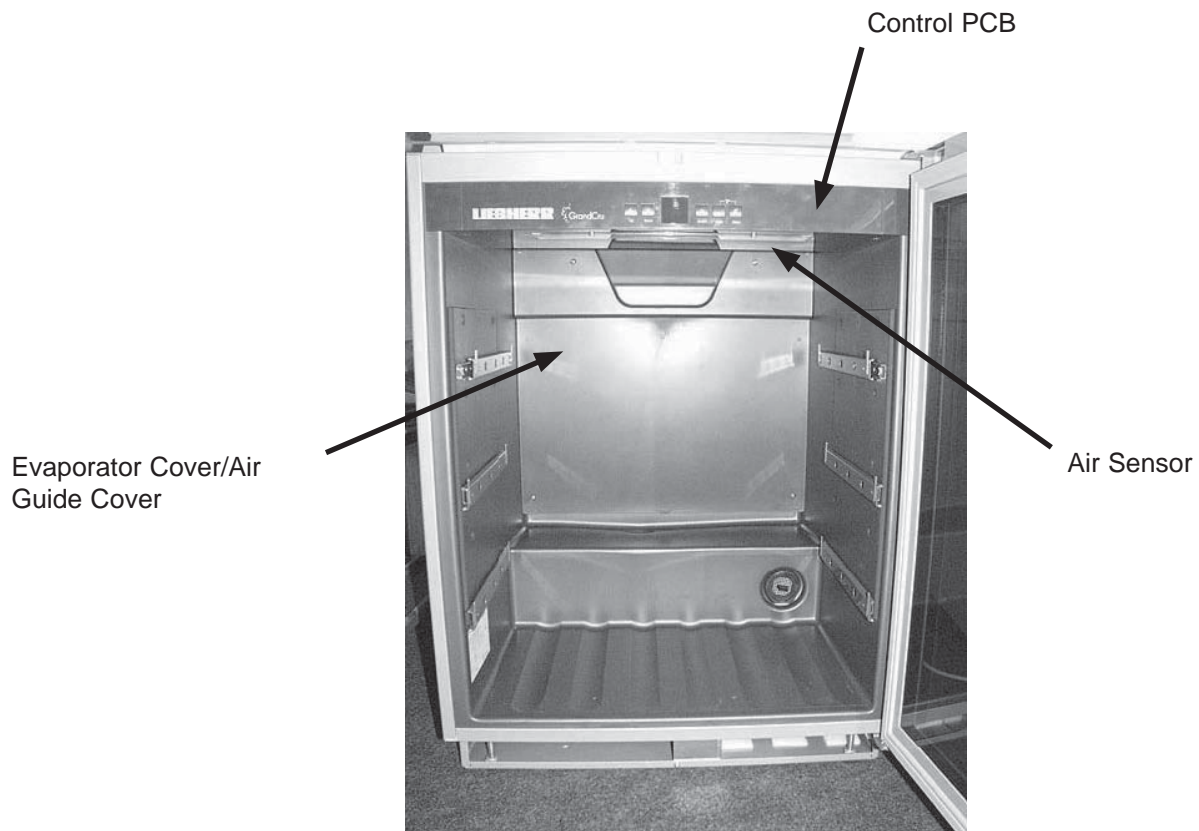



## Section 4 - Control and Functional Components

<b>Electronic control system</b>	6-series electronic control system – control panel PCB, power PCB (microcontroller on power PCB) <u>Position:</u> In light housing.
<b>Setting range</b>	+37°F to +68°F (+3°C to +20°C)
<b>Display range</b>	1°F to 99°F (-17°C to 38°C) - if fallen short of or exceeded, the value remains The display is corrected with an offset value.
<b>Temperature alarm</b>	When: The alarm is set off if the temperature falls short of or exceeds the <b>set value by 4K for longer than 20 minutes.</b>  Audible: 4 beeps The audible alarm can be acknowledged by means of Alarm OFF button. The audible alarm is suppressed during initial operation.  Visual: Temperature display flashes.
<b>Door alarm</b>	When: After the door has been open for 60 seconds.  Audible: 3 beeps. The alarm can be acknowledged by means of Alarm OFF button.  The alarm is active again the next time the door switch is actuated.
<b>Temperature control</b>	<b>Depending on the set values and the respective sensor value</b> , the compressor is switched on and off.
<b>Air sensor</b>	<u>Position:</u> On the upper side of the air guide cover. <u>Function:</u> Attends to switching the compressor on and off.
<b>Defrosting</b>	The evaporator defrosts <b>during the cooling pauses</b> (without electric heater or similar)
<b>Defrost water channel heater</b>	<u>Position:</u> Adhesively affixed to the underside of the compartment liner. <u>Function:</u> <ul style="list-style-type: none"> <li>• Permanently active (also when the appliance is switched off)</li> <li>• Ensures that the drain does not freeze.</li> </ul>
<b>Interior fan</b>	<u>Position:</u> In the interior, above the evaporator. <u>Function:</u> <ul style="list-style-type: none"> <li>• <b>Attends to rapid cooling and steady temperatures</b> (see button combination for interior fan).</li> <li>• When the compressor is at a standstill for longer than 40 minutes the fan runs permanently (e.g. cool ambient temperature).</li> </ul> <p>The fan is switched off when the door is open.</p>
<b>Button combination for interior fan</b>	ON: The fan runs permanently. OFF: The fan runs parallel with the compressor.
<b>Condenser fan</b>	<u>Position:</u> In the base, on the right. <u>Function:</u> Attends to the <b>ventilation of the condenser and compressor</b> it runs in parallel with the compressor.

## SECTION 4 - CONTROL AND FUNCTIONAL COMPONENTS

---

### Control and Functional Components (continued)

---

<b>Interior light</b>	Position: In light housing. Function: See <i>Button for interior light</i>
<b>Button for interior light</b>	ON: Interior light is permanently active. OFF: Interior light is active only when door is open.
<b>Control Panel</b>	Position: Houses the light and electronic control system. Function: <ul style="list-style-type: none"><li>• switches interior fan off when door is open.</li><li>• switches interior light on when door is open.</li></ul>
<b>On/Off button</b>	Switches the entire appliance on and off.

## Section 5 - Refrigeration Circuit

<b>Evaporator</b>	Freely suspended rear wall evaporator
<b>Condenser</b>	Helical condenser (dynamically ventilated) + frame heating
<b>Compressor</b>	Standard compressor
<b>Refrigerant</b>	R134a

## Section 6 - Special Features

### Plinth for Ventilation and Air Extraction

Ventilation and air extraction take place in the base of the appliance. A fan takes in the air on the righthand side via a helical condenser and blows it out again on the lefthand side via the compressor.

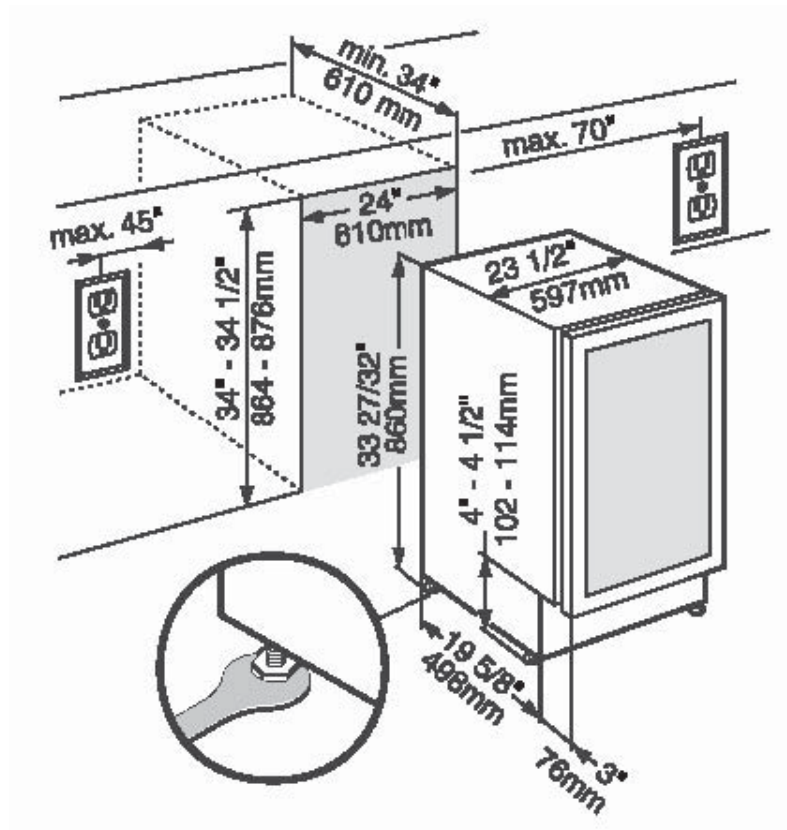

### Fan Function

For long-term wine storage, the humidity in the appliance can be increased by activating the fan function (the LED button shines). The fan then runs permanently and switches off only when the door is open.

## Section 7 - Assembly Instructions

### Disassembling the Electronic Control System

#### Electronic control system:

1. Remove upper hinge pin and remove door.
2. Undo both fastening screws on the underside of the light housing, draw the housing forwards and tip it downwards.
3. Disconnect cable.

#### PCBs:

1. Unclip PCB carrier.
2. Remove PCB and control PCB from PCB carrier.



### NOTE

To facilitate detaching the PCBs, the light housing can be pulled out in full and removed from the appliance.

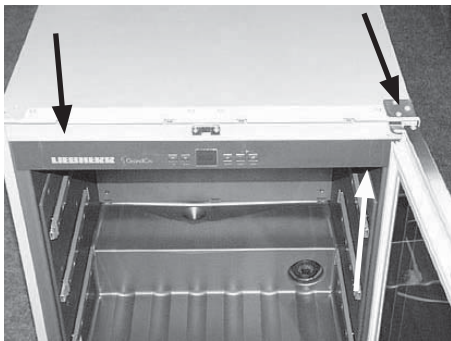

**FIG. 7.1/1**

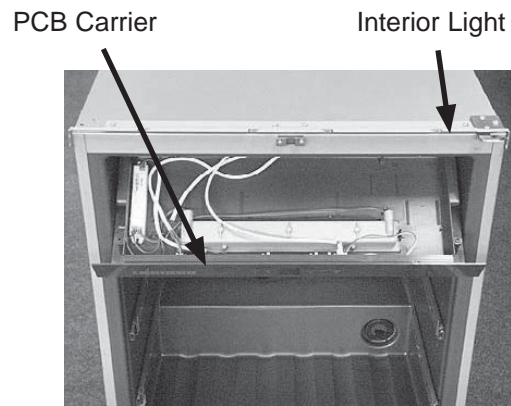

**FIG. 7.1/2**

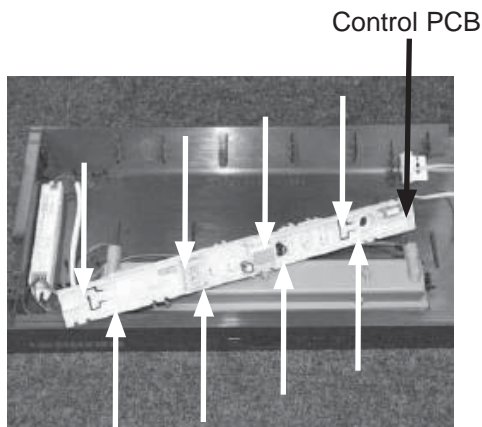

**FIG. 7.1/3**

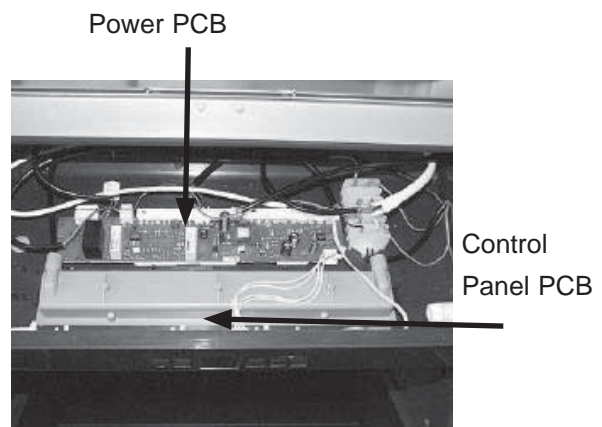
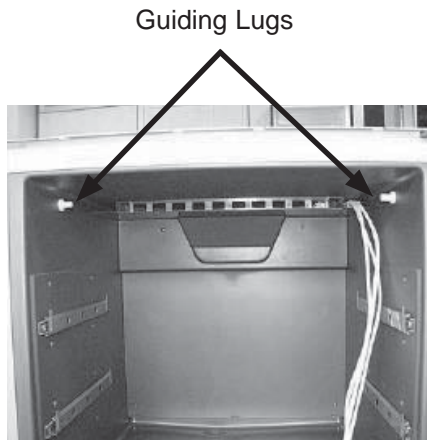

**FIG. 7.1/4**

## Detaching Light Housing

### Light housing:

1. Hold light housing in a horizontal position and draw it out in a forward direction.
2. As soon as the stops strike the lugs, raise the housing a little and remove it.



**FIG. 7.2/1**

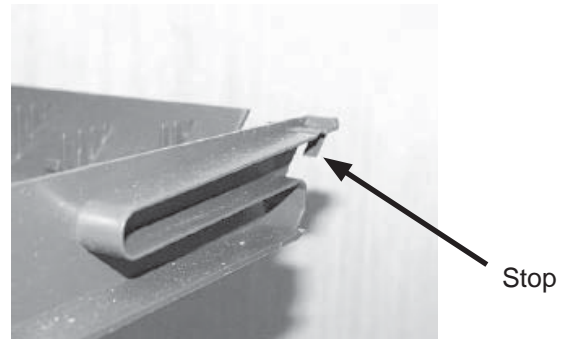
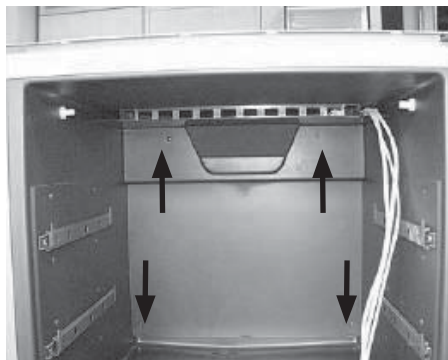

**FIG. 7.2/2**

## Disassembling the Sensors

### Sensor:

1. Undo four (4) fastening screws and tip cover forwards (detach top couple of rails if necessary).
2. Remove sensor.



**FIG. 7.3/1**

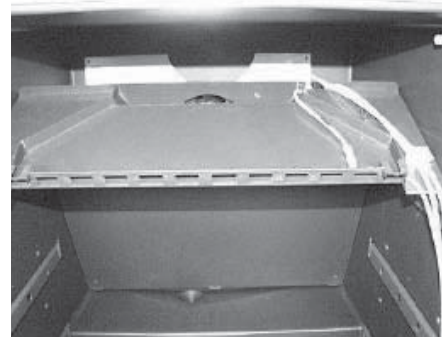

**FIG. 7.3/2**

## Disassembling the Fan

---

### Fan:

1. Place evaporator cover on rails or remove (detach top couple of rails if necessary).
2. Disconnect fan and pull from the holder. During assembly, make sure the absorber ring is seated properly!

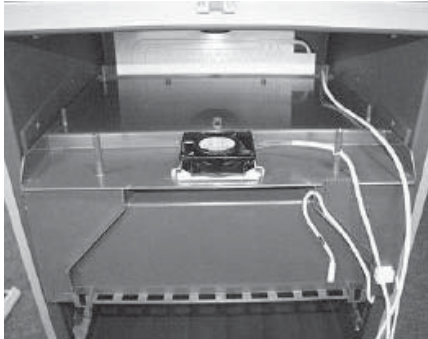

**FIG. 7.4/1**

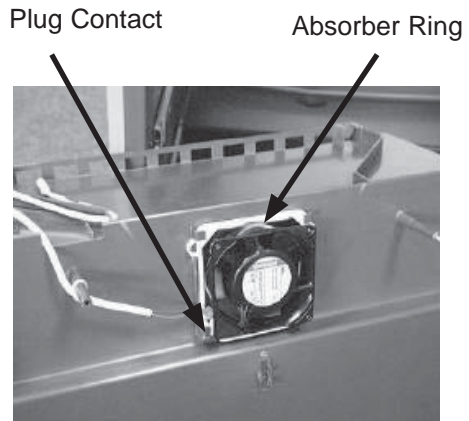

**FIG. 7.4/2**

**Section 8 - Technical Data**

<b>Evaporator fan</b>	Voltage: 115 volts, 60 Hz. Wattage: 5 watts Speed: 1850 rpm
<b>Condenser fan</b>	Voltage: 115 volts, 60 Hz Wattage: 7 watts Speed: 1600 rpm
<b>Defrost water channel heater</b>	Voltage: 115 volts, 60 Hz. Wattage: 1.5 watts

<b>Sensor Values</b>	
<b>TEMPERATURE °F</b>	<b>(°C) RESISTANCE KOHM</b>
95 (+35)	3.1
86 (+30)	3.8
77 (+25)	4.7
68 (+20)	5.9
59 (+15)	7.3
50 (+10)	9.3
41 (+5)	11.9
32 (0)	15.3
23 (-5)	19.8
14 (-10)	25.9
5 (-15)	34.1
-4 (-20)	45.3
-13 (-25)	60.8
-22 (-30)	82.3
-31 (-35)	112.8



## Section 9 - Service Menu

### Service Menu

---

The service menu may be used only by customer service technicians.

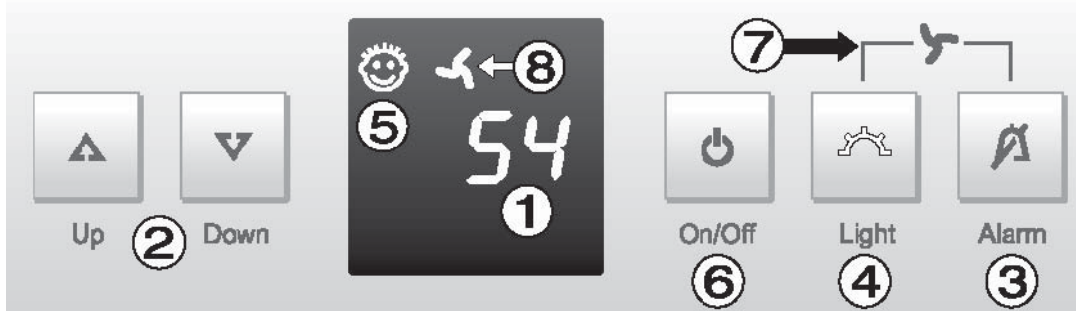

### Demo Mode

---

1. Press Light button and On/Off button simultaneously for three (3) seconds.
2. "d1" or "d0" in display.
3. d1 = demo mode is deactivated. To activate the demo mode, press "Light".
4. d0 = demo mode is activated. To deactivate the demo mode, press "Light".
5. If no change is wanted, do not press "Light" but "On/Off".
6. When the demo mode is active, the compressor and fan are not activated. In the display 54°F (12°C) is shown.
7. Attention: The demo mode **cannot** be deactivated by power OFF/ON. This is possible only via the service menu.

### Service Mode

---

1. Press Light button and On/Off button simultaneously for three (3) seconds.
2. Press "Up" once until "L" flashes.
3. Press "Light", you are now in the service mode.
4. "rd" flashes.
5. Open and close door.
6. All segments / LEDs are lit.
7. Press all the buttons. Each press of a button is confirmed by a beep.
8. Two (2) seconds alarm tone.
9. Display L0.
10. All the loads can be individually addressed using "Up" or "Down".
  - L1: No load ON
  - L2: Compressor
  - L5: Interior light
  - L7: Fan
11. End with "On/Off".

### Sensor Test (temperature display) and Door Contact Test

---

1. Press Light button and On/Off button simultaneously for three (3) seconds.
2. Press "Up" twice until "E" flashes.
3. Press "Light".
4. The appliance is in sensor test mode and operates in the service mode.
5. All the sensor values and door contacts can be called with "Up" and "Down".
  - E1: Air sensor
  - E9: Door contact (0 = door closed, 1 = door open)
6. End by pressing "On/Off" twice.

## Section 10 - Table of Error Codes

### Table of Error Codes

---

<b>F1</b>	Air sensor
<b>FE</b>	EEPROM on the power PCB
<b>FA, FC, FD, FE, FP</b>	Only for factory testing. Not relevant for customer service.
<b>F6, F7, F8, F9, SE</b>	Only for factory testing. Not relevant for customer service.

If a sensor error is detected, the compressor is switched off.

### Section 11 - Customer Menu

#### Customer Menu

---

In the customer menu the customer can activate the child proofing function, change the brightness of the temperature display and alter the unit for the temperature display to °C.

#### Child Proofing

---

1. Press Light button for five (5) seconds.
2. "c" in display.
3. Press "Light".
4. "c" in display and flashing "0" (child proofing deactivated) or "1" (child proofing activated).
5. The function wanted (c0 or c1) can be selected using "Up" and "Down".
6. Confirm with "Light".
7. When child proofing is active, the "Child proofing" symbol is lit in the display.
8. Change over to normal mode using "On/Off".

#### Display Brightness

---

1. Press Light button for five (5) seconds.
2. "c" in display.
3. Press "Up" once-> "h" flashes
4. Press "Light".
5. "h" in display and flashing "1" to "5" (5 = max. brightness).
6. Set the brightness wanted using "Up" and "Down".
7. Confirm with "Light".
8. Change over to normal mode using "On/Off".

#### Changing the Unit for the Temperature Display (°F -> °C)

---

1. Press Light button for five (5) seconds.
2. "c" in display.
3. Press "Up" twice-> "°" flashes.
4. Press "Light".
5. "°F" in display.
6. Change to "°C" using "Down".
7. Confirm with "Light".
8. "°" in display.
9. Change over to normal mode using "On/Off".