



DISHWASHER

Model Name: DMR78 Series

DMR77 Series

DMR57 Series

Model Code : DMR78AHS/XAA DMR78AHS/XAC
DMR78AHB/XAA DMR78AHB/XAC
DMR78AHW/XAA DMR78AHW/XAC
DMR77LHS/XAA DMR77LHS/XAC
DMR77LHB/XAA DMR77LHB/XAC
DMR77LHW/XAA DMR77LHW/XAC
DMR57LFS/XAA DMR57LFS/XAC
DMR57LFB/XAA DMR57LFB/XAC
DMR57LFW/XAA DMR57LFW/XAC

SERVICE Manual

DISHWASHER



CONTENTS

1. Safety Instructions
2. Features and Specifications
3. Disassembly and Reassembly
4. Troubleshooting
5. Exploded Views and Parts List
6. PCB Diagram
7. Wiring Diagram
8. Schematic Diagram
9. Reference

Refer to the service manual in the GSPN (see the rear cover) for the more information.

Contents

The issues of changing.....	4
1. Safety Instructions	1-1
1-1. Safety Instructions for Service Engineers.....	1-1
2. Features and Specifications	2-1
2-1. Features	2-1
2-2. Specifications	2-2
2-3. Comparing Specifications with Existing Models	2-3
2-4. Options Specifications.....	2-5
3. Disassembly and Reassembly	3-1
3-1. Tools for Removal and Reassembly	3-1
3-2. Standard Disassembly Drawings.....	3-2
3-3. Checkpoints after Finishing a Service	3-23
4. Troubleshooting	4-1
4-1. Changed Components.....	4-1
4-2. Service Inspection Mode	4-2
5. Exploded Views and Parts List.....	5-1
5-1. MAIN (DMR77, DMR78).....	5-2
5-2. ASSY-DOOR (DMR77, DMR78).....	5-4
5-3. ASSY-TUB (DMR77, DMR78)	5-6
5-4. ASSY-BASE (DMR77, DMR78).....	5-8
5-5. ASSY-SUMP (DMR77, DMR78)	5-10
5-6. ASSY-CASE (DMR77, DMR78).....	5-12
5-7. MAIN (DMR57)	5-14
5-8. ASSY-DOOR (DMR57).....	5-16
5-9. ASSY-TUB (DMR57).....	5-18
5-10. ASSY-BASE (DMR57)	5-20
5-11. ASSY-SUMP (DMR57).....	5-22
5-12. ASSY-CASE (DMR57).....	5-24
6. PCB Diagram.....	6-1
6-1. Old PBA - Main PCB.....	6-1
6-2. New PBA- Main PCB.....	6-2
6-3. Old PBA - Detailed Specifications and Descriptions for Connectors and Relay Terminals (MAIN PBA).....	6-3
6-4. New PBA- Detailed Specifications and Descriptions for Connectors and Relay Terminals (MAIN PBA)	6-4
6-5. Detailed Specifications and Descriptions for Connectors (TOUCH 7KEY - DMR77, DMR78).....	6-5
6-6. Detailed Specifications and Descriptions for Connectors (TOUCH 7KEY - DMR57)	6-6
6-7. Detailed Specifications and Descriptions for Connectors (TOUCH 3KEY - DMR77,DMR78).....	6-7
6-8. Detailed Specifications and Descriptions for Connectors (DISPLAY LED - TOP - DMR77, DMR78 (DD07-00008A, 8B))	6-8

6-9. Detailed Specifications and Descriptions for Connectors (DISPLAY LED - FRONT - DMR77, DMR78 (DD07-00009A, 9B)).....	6-8
6-10. Detailed Specifications and Descriptions for Connectors (DISPLAY LED - FRONT - DMR57).....	6-9
7. Wiring Diagram.....	7-1
7-1. Old Wiring Diagram (DMR77/78).....	7-1
7-2. Old Wiring Diagram (DMR57).....	7-2
7-3. New PBA - Wiring Diagram (DMR78, DMR77 , DMR57)	7-3
8. Schematic Diagram	8-1
8-1. MAIN CONTROL (DMR78, DMR77 , DMR57)	8-1
8-3. TOUCH KEY (7KEY - DMR77, DMR78).....	8-2
8-4. TOUCH KEY (3KEY - DMR77, DMR78).....	8-3
8-5. TOUCH KEY (7KEY - DMR57).....	8-4
9. Reference	9-1
9-1. Model Number Naming Rules	9-1
9-2. Terminology	9-2

The issues of changing

Date	Contents
2008. 12. 01	<ul style="list-style-type: none"><li data-bbox="466 286 1209 347">▶ Add the Model(DMR78) Change the Service inspection mode entry method. (Page 4-1)<li data-bbox="466 376 1045 407">▶ Add the Assy-install kit for SVC parts (Page 2-5)

1. Safety Instructions

1-1. Safety Instructions for Service Engineers

- ▶ Make sure to observe the following instructions to operate the product correctly and safely and prevent possible accidents and hazards while servicing.
- ▶ Two types of safety symbols, Warning and Caution, are used in the safety instructions.



Warning Hazards or unsafe practices that may result in severe personal injury or death.



Caution Hazards or unsafe practices that may result in minor personal injury or property damage.

Warning

Before Servicing

- (When servicing electrical parts or harnesses) Make sure to disconnect the circuit breaker or power cable before servicing.
 - Failing to do so may result in a risk of electric shock.
- Do not allow consumers to connect several appliances to a single power outlet at the same time.
 - There is a risk of fire due to overheating.
- When removing the power cord, make sure to hold the power plug when pulling the plug from the outlet.
 - Failing to do so may damage the plug and result in fire or electric shock.
- When the dishwasher is not being used, make sure to disconnect the circuit breaker or power cable from the power outlet.
 - Failing to do so may result in electric shock or fire due to lightning.
- Do not place or use gasoline, thinners, alcohol, or other flammable or explosive substances near the dishwasher.
 - There is a risk of explosion and fire caused from electric sparks.

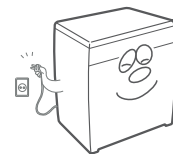
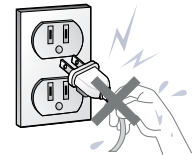
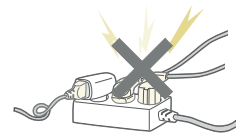

1. Safety Instructions

While Servicing

- Check if the power cable is damaged, flattened, cut or otherwise degraded.
 - If faulty, replace it immediately.
Failing to do so may result in electric shock or fire.
- Completely remove any dust or foreign material from the housing, wiring and connection parts.
 - This will prevent a risk of fire due to tracking and shorts in advance.
- When connecting wires, make sure to connect them using the relevant connectors and check that they are completely connected.
 - If tape is used instead of the connectors, it may cause fire due to tracking.
- Make sure to discharge the PBA power terminals before starting the service.
 - Failing to do so may result in a high voltage electric shock.
- When replacing the heater, make sure to fasten the holder heater after ensuring that it is inserted into the bracket-heater.
 - If not inserted into the bracket-heater, it touches the tub and causes noise and electric leakage.

After Servicing

- Check for any water leakage.
 - Perform a test run for the dishwasher using the standard(normal) cycle and check whether there is any water leakage through the floor section or the pipes.

- Do not allow consumers to repair or service any part of the dishwasher themselves.
 - This may result in personal injury and shorten the product lifetime.



- If it seems that grounding is needed due to water or moisture, make sure to run grounding wires.
(Check the grounding of the power outlet, and additionally ground it to a metallic water pipe.)
 - Failing to do so may result in electric shock due to electric leakage.

[Running a grounding wire]

 - Twist a grounding wire (copper wire) two or three times around the tap.
 - If you connect the grounding wire to a copperplate, bury it 75 cm under the earth in a place with a lot of moisture.
 - * Do not connect the grounding wire to a gas pipe, plastic water pipe or telephone wire. There is a risk of electric shock or explosion.

⚠ Caution**Before Servicing**

- Do not sprinkle water onto the dishwasher directly when cleaning it.
 - This may result in electric shock or fire, and may shorten the product lifetime.

- Do not place any containers with water on the dishwasher.
 - If the water is spilled, it may result in electric shock or fire. This will also shorten the product lifetime.

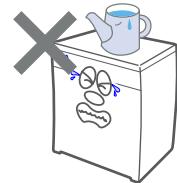

- Do not install the dishwasher in a location exposed to snow or rain.
 - This may result in electric shock or fire, and shorten the product lifetime.



- Do not press a control button using a sharp tool or object.
 - This may result in electric shock or damage to the product.

During Servicing

- When wiring a harness, make sure to seal it completely so no liquid can enter.
 - Make sure that they do not break when force is exerted.

- Check if there is any residue that shows that liquid entered the electric parts or harnesses.
 - If any liquid has entered into a part, replace it or completely remove any remaining moisture from it.

- If you need to place the dishwasher on its back for servicing purposes, place a support(s) on the floor and lay it down carefully so the back is on the floor.
 - Do not lay it down on its front or side. This may result in scratches to the surface or damage to the parts.

After Servicing

- Check the assembled status of the parts.
 - They must be the same as before servicing.
- Check the insulation resistance.
 - Disconnect the circuit breaker or power cable from the power outlet and measure the insulation resistance between the power wires and the grounding wire of the dishwasher. The value must be greater than 10MΩ when measured with a 500V DC Megger.
- Check whether the product is level with the floor. Check if there are any deformations in the sink. Check that the dishwasher is firmly installed to the sink.
 - Vibrations can shorten the lifetime of the product.

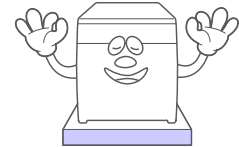

2. Features and Specifications

2-1. Features

Features	Description	Remarks
Extra large capacity	▶ The upper rack is slanted for larger dishes. The space has been maximized to accommodate a variety of dish sizes.	Applicable to all of the DMR77, DMR78 and DMR57 models
Elegant design with digital touch sensors	▶ Digital touch sensors are used in the control panel for more simple operation, with a touch of elegance.	
Increased convenience	▶ The smart auto cycle determines the level of soil on the dishes and initiates the optimal cycle using this feature saving water, energy and time. (DMR77 and DMR78 only)	
Extremely quiet operation	▶ Efficient noise control technology is used for the quietest possible operation. Your new Samsung dishwasher will be quieter than ever.	
Self-cleaning filter	▶ Cleaning the filter yourself is a thing of the past! This product keeps food waste internally while operating, then drains it automatically with the water.	

2-2. Specifications

Wash capacity	14 place settings
Type	Dishwasher
Model	DMR78AHS, DMR78AHB, DMR78AHW DMR 77LHS, DMR 77LHB, DMR 77LHW DMR 57LFS, DMR 57LFB, DMR 57LFW
Power	Single-phased alternating current of 60Hz, 15A at 120V
Used water pressure	20 ~ 120 psi (140 ~ 830 kPa)
Wash type	Rotating nozzle spray
Dry type	Condensed dry system
Power usage	Main Motor : 165W / Heater : 1100W
Standard amount of used water	3.9~7.7 gallon(14.8~29ℓ), Normal Cycle
Size (W×D×H)	23 7/8" x 24 3/4" x 33 7/8" inch (605 x 622 x 860 mm)

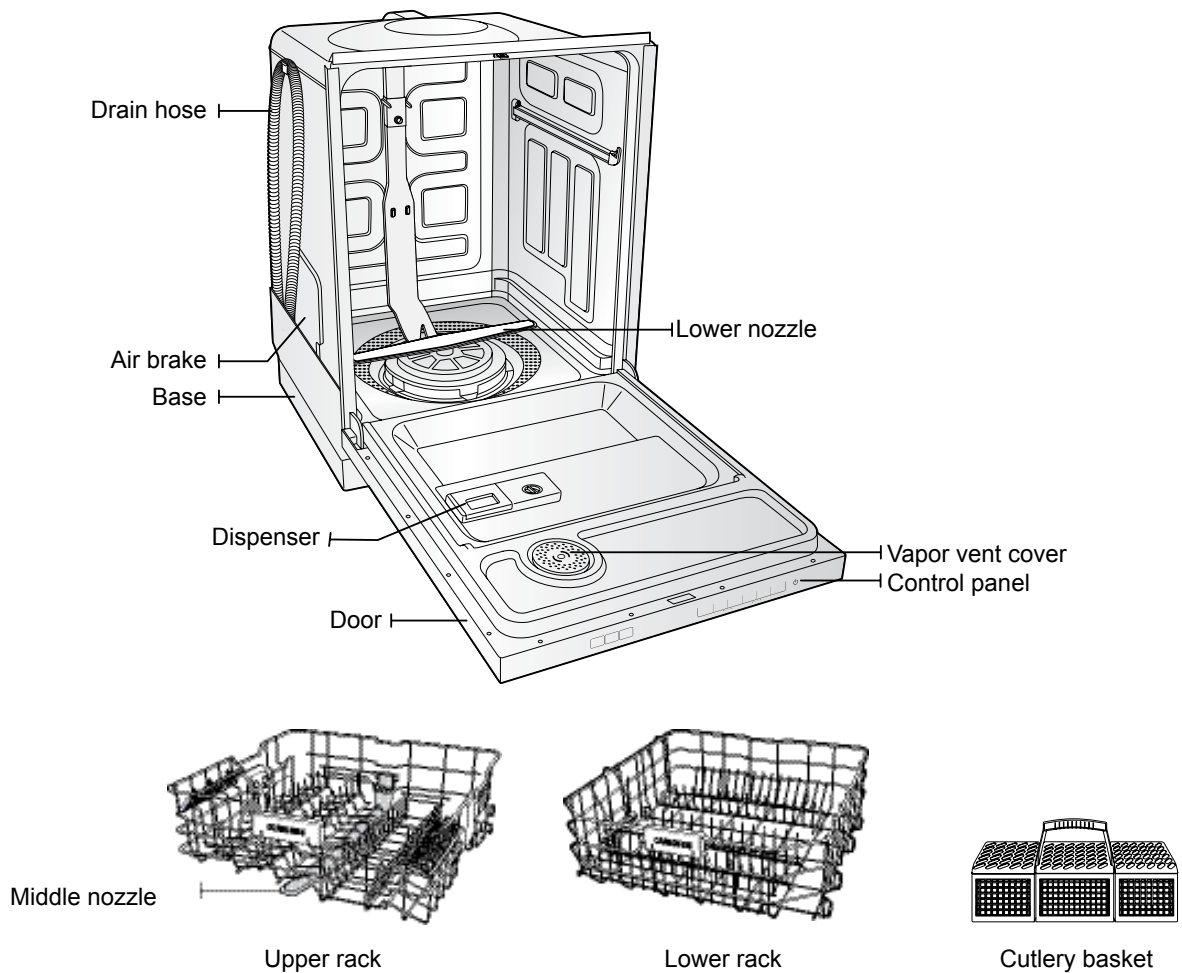

Above images might differ in the dishwasher models.







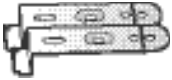

2-3. Comparing Specifications with Existing Models

Model	BEST MODEL			BETTER MODEL			GGH DESIGN
	DMR 77LHS	DMR 77LHB	DMR 77LHW	DMR 57LFS	DMR 57LFB	DMR 57LFW	DMR78AHS
Photo							
	Design Specifications						
Panel Control	Black	Black	Black	Silver	Black	White	Black
Frame Front	STS	Black	White	STS	Black	White	STS
Handle	Aluminum	Black	White	X	X	X	STS
Cover Handle	X	X	X	Cr	Black	Cr	X
Cover Front L	Silver	Black	White	Silver	Black	White	Silver
	Functional Specifications						

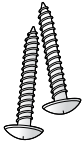
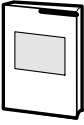
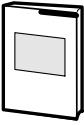
2. Features and Specifications

Model	BEST MODEL			BETTER MODEL			GGH DESIGN
	DMR 77LHS	DMR 77LHB	DMR 77LHW	DMR 57LFS	DMR 57LFB	DMR 57LFW	
	Functional Specifications						
Soil Detection Sensors	○	○	○	○	○	○	○
Basket Height Adjustment	One-touch	One-touch	One-touch	2-stage	2-stage	2-stage	One-touch
Half Load	○	○	○	X	X	X	○
Child Lock	○	○	○	○	○	○	○
Smart Auto	○	○	○	X	X	X	○
Sanitize	○	○	○	○	○	○	○
Leakage Sensor	○	○	○	○	○	○	○
Fan Motor	○	○	○	○	○	○	○
Delay start	○	○	○	○	○	○	○
Quick cycle	○	○	○	X	X	X	○

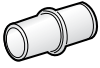
2-4. Options Specifications

Photo	Item	Code	Quantity	Remarks
	Bracket-install	DD61-00176A	2	Provided with the dishwasher
	Assy-install kit for Top mounting (Bracket-install + Screw)	DD94-01002A	2+2	
	Screw for side mounting	DD81-01266A	2	
	User Manual	DD68-00036A(DMR78) DD68-00018A(DMR77) DD68-00026A (DMR57)	1	
	Installation Guide	DD68-00027A	1	Sold separately
	Elbow	-	1	
	Water Supply Line (Flexible STS supply line is recommend)	-	1	
	Air Gap	-	1	
	Rubber Connector	-	1	
	Hose Clamp	-	1	
	Strain Relief	-	1	

Memo

3. Disassembly and Reassembly



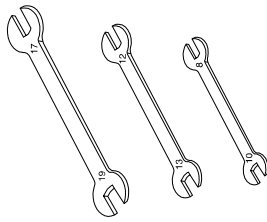
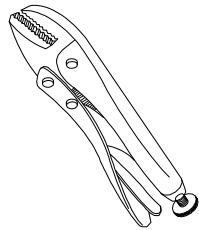
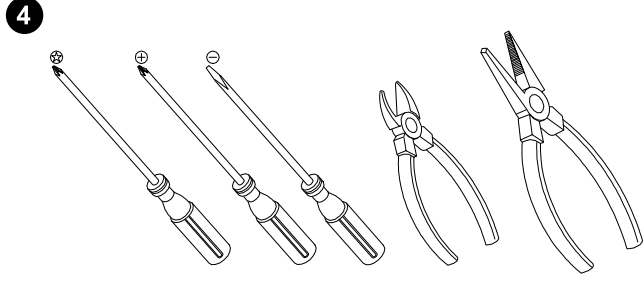

3-1. Tools for Removal and Reassembly







Tool image									
									
No.	Tool	Type	Remarks						
①	Adjustable Wrench								
②	Open-end Wrench	1-7/16"	Leg						
③	Vice pliers								
④	Others (screwdriver, nipper, long nose pliers)		Common tools for servicing Screwdriver - Philips, flat, Torx T20						

* Preparation for parts replacement



1. Take out the residual water inside the product.
(Drain the water by operating the drain pump)
2. Close the water supply valve.
3. Turn off the power & disconnect power cable.
You must turn off the circuit breaker connected to the product.
4. Pull out the unit from the sink and lay it on the floor.
Be careful of the drain hose when pulling out the unit.





3-2. Standard Disassembly Drawings

Part	Photo	Description
		<p>1. Place the dishwasher on its back so that you can see the base. Remove the two (2) screws that hold the base and the shutter in place.</p>
Thermistor		<p>2. Remove the leakage sensor connector (white) inside the shutter.</p>
		<p>3. Disconnect the wire terminal (blue) connected to the thermistor.</p>
		<p>4. Check the location of the thermistor and remove the two (2) screws that hold the thermistor to the case sump.</p>





Part	Photo	Description
		<ol style="list-style-type: none"> 1. Open the door completely. Remove the upper and lower baskets. Place the baskets you've just removed in a safe location so that they do not interfere with the service operations and to prevent them from being damaged.
		<ol style="list-style-type: none"> 2. Use your hand to hold the lower nozzle and remove it. Place the removed lower nozzle in a safe location along with the basket etc.
		<ol style="list-style-type: none"> 3. Hold the nozzle duct, and rotate and remove it. To remove it smoothly, remove the hooks clamping the bracket duct (U) using a flat screwdriver and remove the hooks clamping the bracket duct (M). Pull them out while rotating them to the left.
Heater		<ol style="list-style-type: none"> 4. Remove the cover heater from the sump assy. You will need a flat screwdriver for the removal. To remove a hook from the cover heater, insert the end of the screwdriver into the gap between cover heater and cover sump, and push the handle of screwdriver and the hook. Remove remain four(4) hooks using same way.
		<ol style="list-style-type: none"> 5. Place the dishwasher on its back so that you can see the base. Remove the two (2) screws that hold the base and the shutter in place. <p>⚠ Caution Before placing the dishwasher on its back, make sure to check whether any water is left. Remove any remaining water. (There is a risk of fire due to a water leakage while servicing).</p>
		<ol style="list-style-type: none"> 6. Remove the leakage sensor connector (white) in the shutter.





3. Disassembly and Reassembly

Part	Photo	Description
Heater		<p>7. Remove the two (2) terminals which are inserted into the heater. Do not pull the wire. Remove it by holding the metallic part at the end of the wire.</p>
		<p>8. Remove the two (2) holder heaters which are connected to the heater by rotating them counterclockwise.</p>
		<p>9. Place the dishwasher the right way up again. Open the door and hold and remove the heater.</p> <p>⚠ Caution The heater may be very hot. Make sure to check it before touching the heater.</p> <p>⚠ Caution Make sure to check whether any water is left. Remove any remaining water, to prevent water leakages while servicing.</p>





Part	Photo	Description
Drain Pump		<ol style="list-style-type: none"> 1. Place the dishwasher on its back so that you can see the base. Remove the two (2) screws that hold the base and the shutter in place.
		<ol style="list-style-type: none"> 2. Remove the leakage sensor connector (white) in the shutter.
		<ol style="list-style-type: none"> 3. Disconnect the two (2) drain pump connectors.
		<ol style="list-style-type: none"> 4. Remove the drain pump by rotating it counterclockwise. When removing the drain pump, lift up the hook holding it in place slightly and then rotate it so that the hook is not damaged.





3. Disassembly and Reassembly

Part	Photo	Description
		<ol style="list-style-type: none"> 1. Open the door completely. Remove the upper and lower baskets. Place the baskets you've just removed in a safe location so that they do not interfere with the service operations and to prevent them from being damaged.
		<ol style="list-style-type: none"> 2. Use your hand to hold the lower nozzle and remove it. Place the removed lower nozzle in a safe location along with the baskets.
Circulation Motor		<ol style="list-style-type: none"> 3. Hold the nozzle duct, and rotate and remove it. To remove it smoothly, remove the hooks clamping the bracket duct (U) using a flat screwdriver and remove the hooks clamping the bracket duct (M). Pull them out while rotating them to the left.
		<ol style="list-style-type: none"> 4. Remove the sump assy. Remove the ten (10) screws on the assy filter mesh. (Except the two (2) screws holding the holder nozzle L in place)



Part	Photo	Description
Circulation Motor		<p>5. Remove the screws and lift up and remove the cover sump. The cover sump, cover scroll, assy filter mesh, holder nozzle L, and cover heater will be removed together.</p> <p>⚠ Caution Place the removed parts in a safe location to prevent them from being damaged.</p>
		<p>6. Remove the Impeller circulation. Remove the screw (1) that is holding the circulation motor to the shaft. Use your hand to hold the impeller circulation and turn the screw.</p> <p>⚠ Caution Turn the screw clockwise to remove it.</p>
		<p>7. Remove the valve distributor. Remove the seal distributor.</p> <p>⚠ Caution Make sure to check whether any water is left. Remove any remaining water to prevent water leakages while servicing.</p>
		<p>8. Remove the case scroll. Check if the seal rubber scroll is normal. If it is damaged or hardened, replace it.</p>
		<p>9. Remove the cutter disposer.</p> <p>⚠ Caution Both sides are sharp. Be careful when removing it.</p>





3. Disassembly and Reassembly

Part	Photo	Description
Circulation Motor		<p>10. Place the dishwasher on its back so that you can see the base. Remove the two (2) screws that hold the base and the shutter in place.</p>
		<p>11. Remove the leakage sensor connector (white) inside the shutter.</p>
		<p>12. Remove the circulation motor connector (white).</p>
		<p>13. Remove the five (5) screws holding the circulation motor and the sump in place.</p> <p>14. Hold and pull the circulation motor to remove it from the sump.</p>

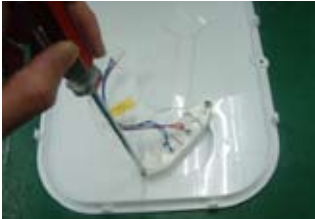



Part	Photo	Description
Distributor Motor		<p>1. Place the dishwasher on its back so that you can see the base. Remove the two (2) screws that hold the base and the shutter in place.</p>
		<p>2. Remove the leakage sensor connector (white) inside the shutter.</p>
		<p>3. Remove the two (2) distributor motor connectors.</p>
		<p>4. Remove the two (2) screws that hold the distributor motor in place.</p> <p>(You can remove one of the two screws through the hole in the base.)</p> <p>Pull the distributor motor out.</p> <p>⚠ Caution Be careful removing because it is combine with rubber seal and distributor valve.</p>

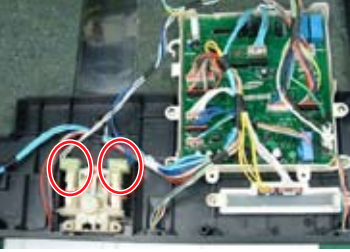

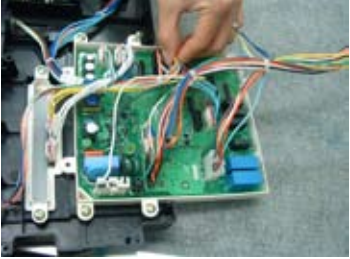

3. Disassembly and Reassembly

Part	Photo	Description
Leakage Sensor		<ol style="list-style-type: none">1. Place the dishwasher on its back so that you can see the base. Remove the two (2) screws that hold the base and the shutter in place.
		<ol style="list-style-type: none">2. Remove the leakage sensor connector (white) inside the shutter.
		<ol style="list-style-type: none">3. Remove the leakage sensor from the shutter by unfastening the two (2) screws holding it in place.



Part	Photo	Description
		<p>1. Open the door completely. Remove the twelve (12) screws holding the tub front, frame front, and panel front in place.</p> <p>⚠ Caution Before removing the screws, place a cushioned mat on the floor to prevent the handle and frame front from being scratched. After removing them, make sure to hold the tub front with your hand while you are working as the tub may close and harm you.</p> <p>⚠ Caution Do not place the removed screws on the tub front. They may fall into the sump assy.</p>
		
Panel Control (DMR78/77 series)		<p>2. Remove the fan motor connector.</p>
		<p>3. Now remove the frame front and the panel control assy. Place it on the floor and perform the following: Remove the panel control from the frame front. You can remove the panel control by holding and pulling it.</p>
		<p>And, you can remove and replace the door lock switch in this step. (Remove both connectors of door lock switch.)</p>





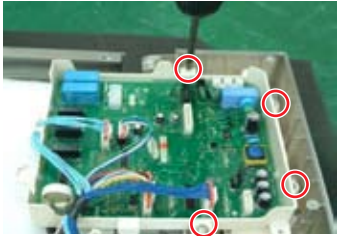

3. Disassembly and Reassembly

Part	Photo	Description
<p>Panel Control (DMR78/77 series)</p>		<p>4. Remove the two (2) screws holding the panel control and the display LED in place.</p>
		<p>5. Remove the two (2) display LED connectors. Now, you can remove the seal guide LED and the display LED.</p> <p>⚠ Caution When reassemble the display LED, ensure to place the seal guide LED on original location.</p>
		<p>6. Remove the four (4) screws holding the PCB assy and panel control in place.</p>
		<p>7. Remove all the connectors connected to the PCB assy.</p>
		<p>8. Remove the two (2) screws holding the display LED (F) and the panel control in place. Remove the two (2) display LED (F) connectors. Now remove the seal guide LED (F) and the display LED (F).</p>





Part	Photo	Description
Panel Control (DMR57 series)		<p>1. Open the door completely. Remove the twelve (12) screws holding the tub front, frame front, and panel front in place.</p> <p>⚠ Caution Before removing the screws, place a cushioned mat on the floor to prevent the handle and frame front from being scratched. After removing them, make sure to hold the tub front with your hand while you are working as the tub may close and harm you.</p> <p>⚠ Caution Do not place the removed screws on the tub front. They may fall into the sump assembly.</p>
		
		<p>2. Remove the fan motor connector.</p>
		<p>3. Now remove the frame front and the panel control assembly. Place it on the floor and perform the following: Remove the panel control from the frame front. You can remove the panel control by holding and pulling it. And, you can remove and replace the door lock switch in this step. (Remove both connectors of door lock switch.)</p>
		<p>4. Remove the two (2) screws holding the panel control and the display LED in place. Remove the two (2) display LED connectors. Now, you can remove the seal guide LED and the display LED.</p>







3. Disassembly and Reassembly

Part	Photo	Description
Panel Control (DMR57 series)		5. Remove the four (4) screws holding the PCB assy and panel control in place. Remove all the connectors connected to the PCB assy.
		6. You can remove the PCB assy.







Part	Photo	Description
Dispenser		<ol style="list-style-type: none"> 1. Open the door completely. Remove the twelve (12) screws holding the tub front, fame front, and panel front in place. <p>⚠ Caution Before removing the screws, place a cushioned mat on the floor to prevent the handle and frame front from being scratched. After removing them, make sure to hold the tub front with your hand while you are working as the tub may close and harm you.</p>
		<p>⚠ Caution Do not place the removed screws on the tub front. They may fall into the sump assy.</p>
		<ol style="list-style-type: none"> 2. Remove the fan motor connector.
		<ol style="list-style-type: none"> 3. Remove the four (4) connectors on both sides of the Dispenser. <p>⚠ Caution The connectors are of the locking type and are hard to remove. Be careful not to break them when removing them.</p>
		<ol style="list-style-type: none"> 4. Remove the six (6) screws holding the tub front and the two (2) racket dispensers in place.
	<ol style="list-style-type: none"> 5. The dispenser is fixed to the tub front with a hook. Use a flat screwdriver to remove it from the tub front. <p>⚠ Caution Be careful as the tub front is sharp.</p>	



3. Disassembly and Reassembly

Part	Photo	Description
Fan Motor		<ol style="list-style-type: none"> 1. Open the door completely. Remove the twelve (12) screws holding the tub front, fame front, and panel front in place. <p>⚠ Caution Before removing the screws, place a cushioned mat on the floor to prevent the handle and frame front from being scratched. After removing them, make sure to hold the tub front with your hand while you are working as the tub may close and harm you.</p>
		<p>⚠ Caution Do not place the removed screws on the tub front. They may fall into the sump assy.</p>
		<ol style="list-style-type: none"> 2. Remove the fan motor connector.
		<ol style="list-style-type: none"> 3. Remove the single (1) screw holding the bracket cover fan in place.

Part	Photo	Description
Fan Motor		<p>4. Remove the cover fan by rotating it counterclockwise.</p> <p>Use a jig. If you have no jig, use a tool such as a pair of long nose pliers. Remove it carefully so that the part is not damaged.</p>
		<p>5. Remove the two (2) screws holding the cover fan in place.</p>
		<p>6. Hold and remove both the case vent assy and the duct condenser assy together which are located at the front of the tub front.</p> <p>⚠ Caution Be careful while removing them as the duct condenser assy is touching the bracket door link and the cushion duct L/R.</p>
		<p>7. Remove the fan motor from the case vent assy. It is connected with two (2) screws and the fan vent is inserted into the shaft of the fan motor. Remove the screws first and carefully pull out the fan motor.</p>
		<p>8. Remove the duct condenser from the case vent assy. Remove the three (3) screws.</p>
	<p>9. Remove the case vent assy, fan motor, fan vent, duct condenser, and seal vent.</p>	



3. Disassembly and Reassembly

Part	Photo	Description
Case Sensor		<p>1. Remove the (2) screws of the L frame.</p>
		<p>2. Remove the L frame.</p> <p>⚠ Caution Make sure to wear gloves when removing the L frame. Be careful as the steel plate may harm you.</p>
		<p>3. Remove the drain hose from the bracket hose drain. Hold the drain hose using both hands and move it up and pull it out.</p>
		<p>4. Use your hand to hold the case brake and rotate the cover brake. Use a jig to remove by rotating the cover brake. If you have no jig, you can use a pair of long nose pliers. It can be separated into a gasket brake, cover brake and case brake.</p>
		
		<p>5. Remove the case sensor assy from the case brake assy. Be careful to avoid breaking them, because they are connected with a hook.</p>





Part	Photo	Description
		<p>6. Separate the case sensor assy into the case sensor and the cover sensor assy. Be careful to avoid breaking them, because they are connected with a hook.</p>
Case Sensor		<p>7. Remove the pole sensor from the cover sensor assy.</p>
		<p>8. Remove the micro switch which is fixed by a hook of the cover sensor assy. Disconnect the micro switch connector.</p>

3. Disassembly and Reassembly

Part	Photo	Description
Inlet Valve & Flow Meter		<p>1. Place the dishwasher on its back and remove two (2) screws on both sides of the cover front lower. Remove the cover front lower.</p>
		<p>2. Remove the water supply line (and elbow)</p> <p>⚠ Caution Make sure to close the faucet before removing the water supply line.</p>
		<p>3. Remove the four(4) screws on both sides of the bracket front lower. Remove the bracket front lower after the guide wire's 4 hooks release .</p> <p>* If the legs are in the way removing the screws, unfasten it a little in the clockwise direction and remove the screws.</p>
		
		<p>4. Remove the two (2) screws and ground wire screw from the inlet valve.</p>
		<p>5. Hold and lift up the inlet valve and release flow meter's clasp on the bottom of the base.</p> <p>* When release flow meter's clasp, push-up using tool.</p>
		<p>6. Pull out the inlet valve until the hose clamp can be removed, and remove the clamp and hose.</p> <p>⚠ Caution Take care when holding and removing the clamp with a tool, as it may bounce and harm you.</p>

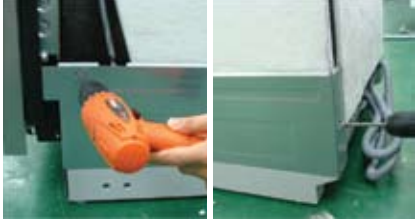
Part	Photo	Description
Inlet Valve & Flow Meter		7. First, case sensor and inlet valve should be removed, then you can remove Flow meter.
		8. Pull the flow meter out of it's hook. And then separate both hose clamps.

3. Disassembly and Reassembly

Part	Photo	Description
		<p>1. Unscrew the screws (2 Screws) connecting the Frame R.</p>
		<p>2. When you separate the Frame R, you can check the Fuse & Relay.</p>
Relay & Fuse		<p>3. Pull out Fuse case that be fixed on hook of Base.</p>
		<p>4. Open the Fuse case. & Check the fuse. & It can replacement.</p>
		<p>5. Separate the terminal of Relay. Unscrew the screws of relay using short-body screwdriver.</p> <p>⚠ Caution If reassemble the terminal of Relay after check or replacement, you must be careful. Don't confuse.</p>

※ Reassembly is in the reverse order of the removal.

3-3. Checkpoints after Finishing a Service

- 1 Check the safety device**
Check the operation of the door lock switch. Make sure that it is locked while the dishwasher is running and that it is unlocked when the dishwasher stops.
- 2. Use authenticated parts only**
If any part is not authenticated, replace it with an authenticated part.
- 3. Handling wires**
Check if any wires are loose or too tight, if they are connected correctly, if they are well bound with tape, and if they are properly clamped.
- 4. The state of screws and nuts**
Check if the screws and nuts are fastened correctly.
Check whether they are fastened with the specified torque.
- 5. Remove foreign material**
Check whether any foreign material such as soil, wire scraps and screws are in the dishwasher. (Check whether any foreign material is entering through the sump into the disposer.)
- 6. Check for water leakage**
Check whether there is water leakage from the hose connector, door, case sump (drain motor, circulation motor, heater, thermistor, turbidity sensor, distributor motor), and the water supply/drain hoses.
- 7. Check the power cable**
Check if there is any damage to the power cable or power outlet. Check that the power capacity is appropriate.
- 8. Check leveling**
Check whether the dishwasher is level.
- 9. Check the installation location**
Check whether the installation location is flat and stable.

Memo

4. Troubleshooting

4-1. Changed Components

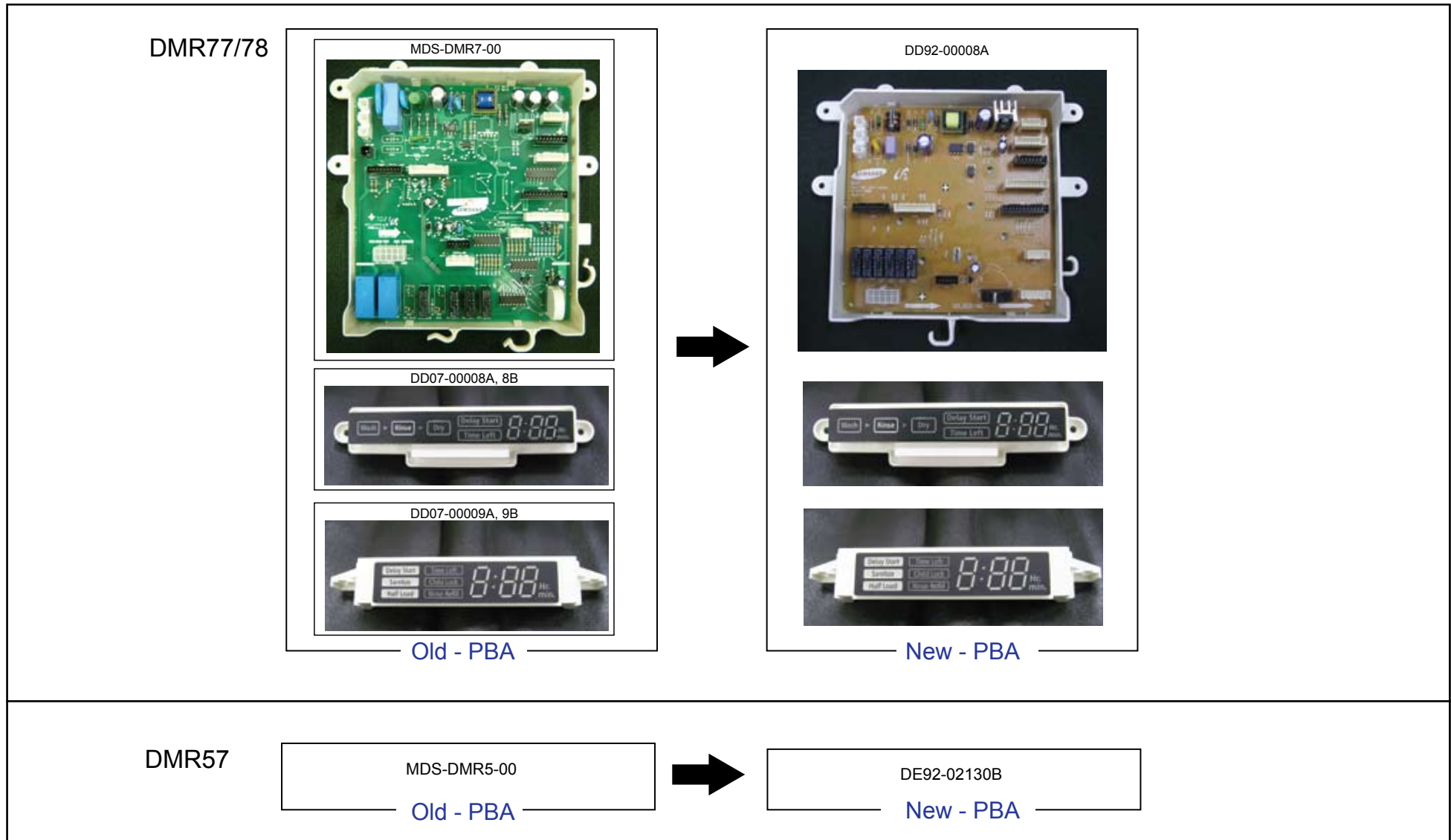

4. Troubleshooting

4-2. Service Inspection Mode

- Press the Delay Start + Normal + Power keys at the same time for two seconds to enter Service Inspection Mode.
- "ALL" is displayed for the first three (3) seconds and then "t1" is displayed.
- You can change the mode by pressing the Normal key. Each time the Normal key is pressed, the mode changes in the order of t1 → t2 → t3 → t4 → t5 → t6 → t7 → t8.
- If you want to activate a mode while operating the dishwasher, the door must be closed (The Door switches are ON.)
- If an "oE", "LE" or "tE1" error occur, make sure to enter Service Inspection Mode after resolving it.
- Service Inspection Mode is described in the following table.

Mode	Related parts	Symptoms	Note
t1	Inlet Valve Flow Meter Low Level Sensor	4E 9E	If you press the Delay Start key, water is drained for 45 seconds and then the water supply starts. If the pulse count is more than 660, change the mode. Make sure to change the mode when the pulse count is more than 660 in t1 mode.
t2	Circulation Motor	A nozzle does not inject water.	1. Press the Delay Start key to start or stop the Circulation Motor. 2. If a low water level is detected, water is supplied again and the operation continues.
t3	Circulation Motor Heater Thermistor	HE	1. Press the Delay Start key to start or stop the heater and the circulation Motor. 2. If a low water level is sensed, water is supplied again and the operation continues. 3. The current temperature is shown on the display. 4. If the water temperature is more than 70°C, the Heater does not operate.
t4	Fan Motor	The Fan Motor does not operate.	Press the Delay Start key to start or stop the Fan Motor.
t5	Drain Pump Low Level Sensor	5E	1. Press the Delay Start key to start the 2 parts. 2. When draining is finished, "t5" is blinking on the Display LED.
t6	Low Level Sensor	When the Micro Switch is turned on/off, there is no change on the display or a symbol other than On/OFF is displayed.	1. MICRO SWITCH On → The sensing state is displayed as 'On' on the 88 segment display. 2. MICRO SWITCH Off → The sensing state is displayed as 'OFF' on the 88 segment display.
t7	Thermistor	There is no change in the water temperature.	The current temperature is displayed.
t8	Half Load Position of Distributor Motor Micro Switch (DMR77 Model)	PE	1. If you press the Delay Start key, the parts operate just once. 2. There is no stop function. 3. While the Distributor Motor is operating, its sensing state is displayed as On/OFF on the 88 segment display. 4. When the Distributor Motor stops, the sensing state (On/OFF) of the Micro Switch is displayed.

Caution

If it has the power problem, you must check the FUSE first.
This dishwasher has the FUSE upon the Base. Refer to the 4-10 page.

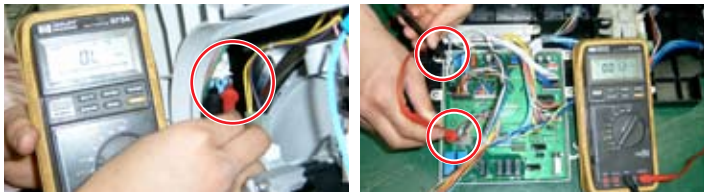
Error type	Error mode	Checking Method	Corrective actions
Water supply error	4E	1. Check whether the faucet is open.	- Open the faucet.
		2. Check whether the water supply has been cut off.	- Close the faucet and turn off the power. Wait until the water supply resumes.
		3. Check whether any foreign material is in the Water Supply Line and the Inlet Valve filter.	- Remove the foreign material. Clean the filter with a brush.
		4. Check the connection for the Inlet Valve connector.	- Reconnect the Inlet Valve connector.
		5. Check whether the coil in Inlet Valve is conductive (Remove the connector before measuring.) ➤ Normal: Approx. 1.2 kΩ	- Faulty: Replace the Inlet Valve. 
		6. Check whether the Inlet Valve is operating normally. - Check the operation of the Inlet Valve ➤ Normal: 120V - Check the Inlet Valve Relay. : Check the voltage between the white wire of the Main PBA CN1 connector and the brown wire of the CN14 ➤ Normal: 120V (while operating) NEW PBA 6-1. Check whether the Inlet Valve is operating normally. - Check the operation of the Inlet Valve ➤ Normal: 120V - Check the Inlet Valve Relay. : Check the voltage between the white wire of the Main PBA CN101 connector and the brown wire of the CN201 ➤ Normal: 120V (while operating)	- Faulty: Replace the Main PBA assy. - Normal: Replace the Inlet Valve 
		7. Check the Power Relay.	- See the "Power Relay error".
		8. Check whether the water supply stops after water is supplied for 5 seconds.	- Replace the Flow Meter.
		9. Check whether the water supply stops after water is supplied for 1 or 5 minutes.	- Check the water supply valve and increase the water pressure.

4. Troubleshooting

Error type	Error mode	Checking Method	Corrective actions
Water supply error	4E1	1. Check the hot water connections for the Inlet Valve.	- Adjust the hot water supply so that the temperate of the supplied water is less than 176°F (80°C)
		2. Check the operation of the Thermistor.	- See the "tE1 error".
Drain error	5E	1. Check whether there is any foreign material in the Drain Hose.	- Remove the foreign material from the Drain Hose.
		2. Check the operation of the Low Level Sensor.	- See the "9E error".
		3. Check the connections for the Drain Pump connector.	- Reconnect the Drain Pump connector.
		4. Check whether the Drain Pump coil is conductive. (Remove the connector before measuring.) ➢ Normal: Approx. 25Ω	- Faulty: Replace the Drain Pump.
		5. Check the operation of the Drain Pump Relay : Check the operating voltage between the white wire of the Main PBA CN1 connector and the amber wire of the CN14 connector. ➢ Normal: 120V (while operating) New PBA 5-1. Check the operation of the Drain Pump Relay : Check the operating voltage between the white wire of the Main PBA CN101 connector and the amber wire of the CN201 connector. ➢ Normal: 120V (while operating)	- Faulty: Replace the Main PBA assy. - Normal: Replace the Drain Pump.
		6. Check the operation of the Power Relay.	- See the "Power Relay error".

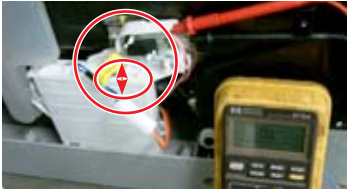

Error type	Error mode	Checking Method	Corrective actions
Low Level error	9E	1. Check the connections for the Low Level Sensor connectors.	<ul style="list-style-type: none"> - Reconnect the Low Level Sensor connectors. 
		2. Check the operation of the Low Level Sensor. <ul style="list-style-type: none"> ➤ Use service inspection mode t6. ➤ Check for foreign material in the floater of the Low Level Sensor. <ul style="list-style-type: none"> - Check the voltage between both ends (pink and brown wires) of the Micro Switch. ➤ When operating normally after water is supplied: <ul style="list-style-type: none"> < 0.5V (Micro Switch On) - Check only the Micro Switch.(Remove the connectors before checking.) ➤ Lift the lever: Short ➤ Lower the lever: Open 	<ul style="list-style-type: none"> - Faulty: Replace the Low Level Sensor, Remove foreign material from the floater - Normal: Replace the Main PBA assy. 
Button error	bE2	<ul style="list-style-type: none"> ● Check whether there is condensation on the Main PBA connectors. <ul style="list-style-type: none"> - CN9 and CN10 for DMR77 model - CN10 for DMR57 model ➤ Normal: No condensation New PBA <ul style="list-style-type: none"> ● Check whether there is condensation on the Main PBA connectors. <ul style="list-style-type: none"> - CN801 and CN803 for DMR78/77 model - CN801 for DMR57 model ➤ Normal: No condensation 	<ul style="list-style-type: none"> - Faulty: Remove any condensation and moisture. - Normal: Replace the Control Panel assy.

4. Troubleshooting

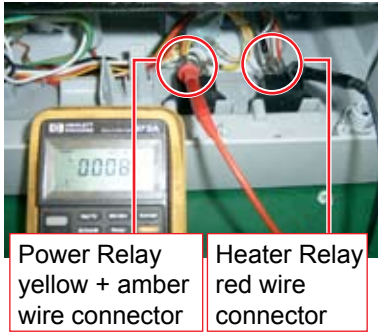
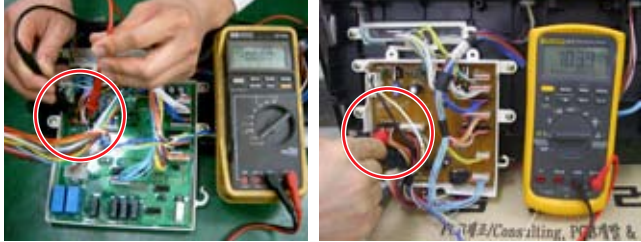
Error type	Error mode	Checking Method	Corrective actions
Heater error	HE	1. Check the connections of the Heater connectors.	- Reconnect the Heater connectors.
		2. Check the resistance between both ends of the Heater. : Check the resistance between both ends of the Heater directly, or check the resistance between the red wire of the Heater Relay and the amber and yellow wires of the Power Relay, respectively. ➤ Normal: Approx. 13Ω * Check after disconnect circuit breaker or power cable.	- Faulty: Replace the Heater. 
		3. Check the connections of the Heater Relay. : Check the voltage between the red wire of the Heater Relay on the base and the yellow and amber wires of the Power Relay. ➤ Normal: 120V (while operating)	- Reconnect the Heater Relay connectors. 
		4. Check the driving signals for the Heater Relay. - Measure the voltage between pin 6 (amber) of the Main PBA CN7 connector and pin 2 (red) of the CN7 connector. ➤ When the Heater is off: 10.5 to 13V ➤ When the Heater is operating: < 0.5V New PBA 4-1. Check the driving signals for the Heater Relay. - Measure the voltage between pin 6 (amber) of the Main PBA CN302 connector and pin 2 (red) of the CN302 connector. ➤ When the Heater is off: 9.5 to 13V ➤ When the Heater is operating: < 0.5V	- Faulty: Replace the Main PBA assy. - Normal: Replace the Heater Relay. 

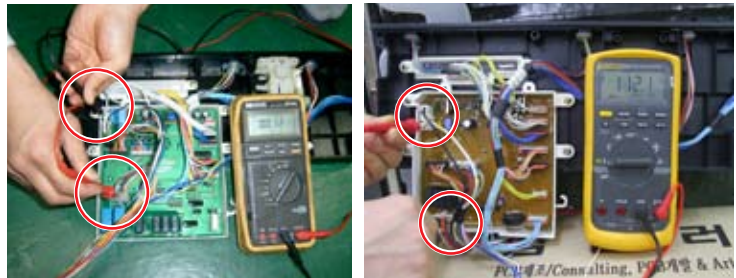
Error type	Error mode	Checking Method	Corrective actions
Heater error	HE1	<ol style="list-style-type: none"> 1. Check the operation of the Thermistor. 2. Check the Heater Relay. 	<ul style="list-style-type: none"> - See the "tE1 Error". - See the "HE Error".
Water leakage error	LE	<ul style="list-style-type: none"> ● Check whether there is any trace of water leakage in the shutter. <ul style="list-style-type: none"> ➢ Normal: No water leakage trace 	<ul style="list-style-type: none"> - Faulty: Check the leakage location. Replace the faulty part. - Nomral: Replace the Main PBA assy.
Half load error	PE	<ol style="list-style-type: none"> 1. Check the connections for the Distributor Motor connectors. 	<ul style="list-style-type: none"> - Reconnect the Distributor Motor connectors.
		<ol style="list-style-type: none"> 2. Check whether the coil in Distributor Motor is conductive. <ul style="list-style-type: none"> : Remove the connectors before measuring. ➢ Normal: Approx. 2.6 kΩ 	<ul style="list-style-type: none"> - Faulty: Replace the Distributor Motor. 
		<ol style="list-style-type: none"> 3. Check whether half load is operating normally. <ul style="list-style-type: none"> - Check the half load operation ➢ Normal: 120V - Check the the operation of Distributor Motor Relay. <ul style="list-style-type: none"> : Check the operating voltage between the white wire of the Main PBA CN1 connector and the violet wire of the CN14 connector. ➢ Normal: 120V (while operating) <p>New PBA</p> <ol style="list-style-type: none"> 3-1. Check whether half load is operating normally. <ul style="list-style-type: none"> - Check the half load operation ➢ Normal: 120V - Check the the operation of Distributor Motor Relay. <ul style="list-style-type: none"> : Check the operating voltage between the white wire of the Main PBA CN101 connector and the violet wire of the CN201 connector. ➢ Normal: 120V (while operating) 	<ul style="list-style-type: none"> - Faulty: Replace the Main PBA assy. 
		<ol style="list-style-type: none"> 4. Check the Power Relay. 	<ul style="list-style-type: none"> - See the "Power Relay error".

4. Troubleshooting

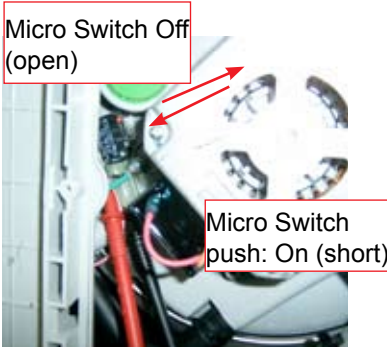
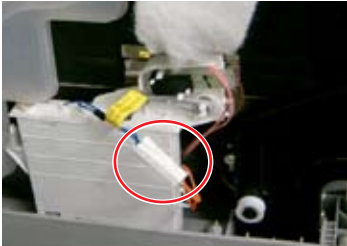
Error type	Error mode	Checking Method	Corrective actions
Half load error	PE	5. Remove the Distributor Motor and check the operation of the motor. (Use t8 service inspection mode .) ➤ Normal: The motor rotates normally.	- Faulty: Replace the Distributor Motor.
		6. Check the position sensing operations when turning the Micro Switch on and off. (Use t8 service inspection mode.) ➤ Check the conduction between the maroon wire and the pink wire. ➤ Micro switch On: Short ➤ Micro switch Off: Open	- Faulty: Replace the Micro Switch for sensing positions. - Normal: Replace the valve distributor and CAM switch. 
Overflow error	oE	1. Check the connections for the Overflow Sensor connector.	- Reconnect the Overflow Sensor connector. 
		2. Check whether the Inlet Valve operates normally. ➤ Use t1 service inspection mode.	- See "4E Error".
		3. Check whether water is supplied (even small amounts) in the intervals when the Inlet Valve is not operating.	- Remove foreign material from the Inlet Valve. - If you cannot remove the foreign material from the Inlet Valve, replace it.

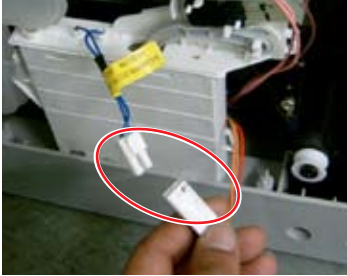
Error type	Error mode	Checking Method	Corrective actions
Overflow error	oE	<p>4. Check whether there is any trace of water leakage on the top of the Case Sensor.</p>	<ul style="list-style-type: none"> - Clean the Hose-Sensor and the Case Sensor. 
		<p>5. Check whether an "oE" error is detected when the assy wire-harness connector for Overflow Sensor is not connected.</p> <ul style="list-style-type: none"> ➤ Normal: The "oE" error does not occur. 	<ul style="list-style-type: none"> - Faulty: Replace the Main PBA assy. - Normal: Replace the Flow Meter. 

4. Troubleshooting

Error type	Error mode	Checking Method	Corrective actions																														
Thermistor error	tE1	1. Check the connections for the Thermistor connector.	- Reconnect the Thermistor connector.																														
		2. Check whether the Thermistor is operating normally. <ul style="list-style-type: none"> - Measure the voltage between both ends of the Thermistor. ➤ Normal: 0.2 to 4.5V - Measure the resistance between both ends of the Thermistor: Remove the connector before measuring. (See the Table right.) <table border="1" data-bbox="692 620 1012 1214" style="margin-left: auto; margin-right: auto;"> <thead> <tr> <th colspan="2" style="text-align: center;">THERMISTOR TABLE</th> </tr> <tr> <th style="text-align: center;">Temp. (°C)</th> <th style="text-align: center;">Resistance (kΩ)</th> </tr> </thead> <tbody> <tr><td style="text-align: center;">5</td><td style="text-align: center;">125.780</td></tr> <tr><td style="text-align: center;">10</td><td style="text-align: center;">98.323</td></tr> <tr><td style="text-align: center;">15</td><td style="text-align: center;">77.454</td></tr> <tr><td style="text-align: center;">20</td><td style="text-align: center;">61.465</td></tr> <tr><td style="text-align: center;">25</td><td style="text-align: center;">49.120</td></tr> <tr><td style="text-align: center;">30</td><td style="text-align: center;">39.517</td></tr> <tr><td style="text-align: center;">35</td><td style="text-align: center;">31.996</td></tr> <tr><td style="text-align: center;">40</td><td style="text-align: center;">26.065</td></tr> <tr><td style="text-align: center;">45</td><td style="text-align: center;">21.358</td></tr> <tr><td style="text-align: center;">50</td><td style="text-align: center;">17.599</td></tr> <tr><td style="text-align: center;">55</td><td style="text-align: center;">14.579</td></tr> <tr><td style="text-align: center;">60</td><td style="text-align: center;">12.140</td></tr> <tr><td style="text-align: center;">65</td><td style="text-align: center;">10.159</td></tr> <tr><td style="text-align: center;">70</td><td style="text-align: center;">8.542</td></tr> </tbody> </table>	THERMISTOR TABLE		Temp. (°C)	Resistance (kΩ)	5	125.780	10	98.323	15	77.454	20	61.465	25	49.120	30	39.517	35	31.996	40	26.065	45	21.358	50	17.599	55	14.579	60	12.140	65	10.159	70
THERMISTOR TABLE																																	
Temp. (°C)	Resistance (kΩ)																																
5	125.780																																
10	98.323																																
15	77.454																																
20	61.465																																
25	49.120																																
30	39.517																																
35	31.996																																
40	26.065																																
45	21.358																																
50	17.599																																
55	14.579																																
60	12.140																																
65	10.159																																
70	8.542																																

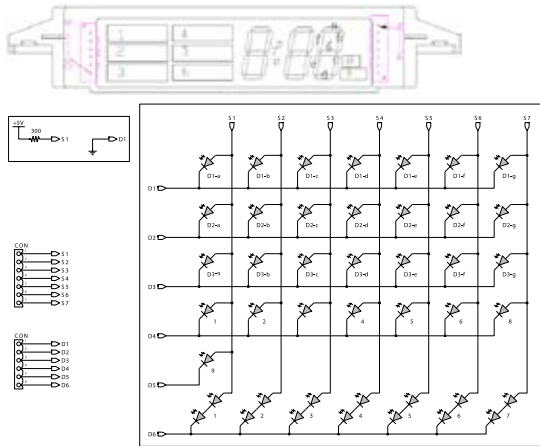
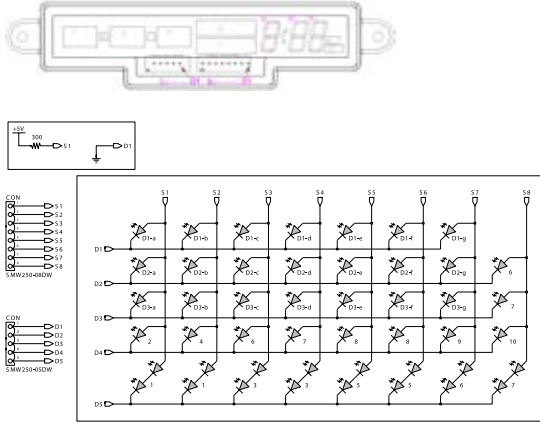

Error type	Error mode	Checking Method	Corrective actions
Power error	None	1. Check the connections for the power plug.	- Reconnect the power plug.
		2. Check the voltage of the power outlet. ➤ Nomral: AC 120V	- Connect to a 120V power source.
		3. If there is a fuse in the right side of the base, check whether the fuse is broken.	- Replace the fuse (15A).
		4. Check the wires of the Main PBA power part. - Measure the voltage between the black wire and the white wire of CN1. ➤ Nomral: AC 120V New PBA 4-1. Check the wires of the Main PBA power part - Measure the voltage between the black wire and the white wire of CN101. ➤ Normal: AC 120V	- Faulty: Check and replace the wires of the power part. 
		5. Check the DC voltage of the Main PBA.	- See "Main PBA DC voltage error".

4. Troubleshooting

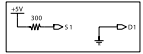
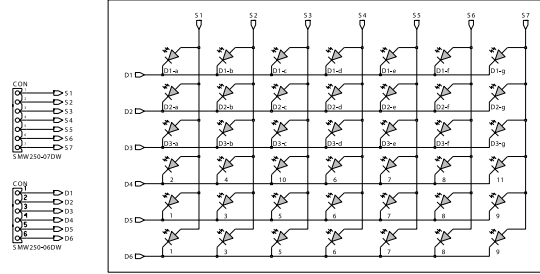
Error type	Error mode	Checking Method	Corrective actions
Display error	None	<p>1. Check the connections for the Display LED connector part.</p>	<p>- Reconnect the connectors for Display LED.</p>
		<p>2-1. Check the Display LED. (the top display of DMR77)</p> <ul style="list-style-type: none"> - Check the number of the part that operates abnormally. Check the LED on that abnormal part by inputting 5V to the S part through a 300Ω resistor and grounding the D part. ➤ Normal: The point lights up normally. <p>Ex) If the D1-a point operates abnormally, check the connections between pin 1 of the 7-pin connector and pin 1 of the 6-pin connector. (See the figure on the right.)</p>	<p>- Faulty: Replace the Display LED.</p> 
		<p>2-2. Check the display LED. (the front display of DMR77)</p> <ul style="list-style-type: none"> - Check the number of the part that operates abnormally. Check the LED on that abnormal part by inputting 5V to the S part through a 300Ω resistor and grounding the D part. ➤ Normal: The point lights up normally. <p>Ex) If the D1-a point operates abnormally, check the connections between pin 1 of the 8-pin connector and pin 1 of the 5-pin connector. (See the figure on the right.)</p>	<p>- Faulty: Replace the display LED.</p> 



Error type	Error mode	Checking Method	Corrective actions
Display error	None	<p>2-3. Check the display LED. (the front display of DMR57)</p> <ul style="list-style-type: none"> - Check the number of the part that operates abnormally. Check the LED on that abnormal point by inputting 5V to the S part through a 300Ω resistor and grounding the D part. ➤ Normal: The point lights up normally Ex) If the D1-a point operates abnormally, check the connections between pin 1 of the 7-pin connector and pin 1 of the 6-pin connector. (See the figure on the right.) 	<ul style="list-style-type: none"> - Faulty: Replace the Display LED.   
		<p>3. Check the DC voltage of the Main PBA.</p>	<ul style="list-style-type: none"> - See the "Main PBA DC voltage error".
Key input part error	None	<p>1. Check Power Key on state.</p>	<ul style="list-style-type: none"> - Try to turn on the Power Key.
		<p>2. Check the connections for the Sub PBA connector part.</p>	<ul style="list-style-type: none"> - Reconnect the Sub PBA connectors..
		<p>3. Check the DC voltage of the Main PBA.</p>	<ul style="list-style-type: none"> - See "Main PBA DC voltage error".

4. Troubleshooting

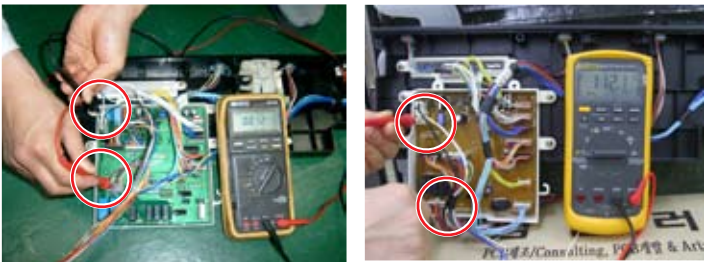
Error type	Error mode	Checking Method	Corrective actions
Dry error	None	1. Check the wire connections for the Fan Motor.	- Reconnect the Fan Motor connectors.
		2. Check the resistance of the Fan Motor coil. (Remove the connector before measuring.) ➢ Normal: Approx. 150 Ω	- Faulty: Replace the Fan Motor assy. 
		3. Check the operation of the Fan Motor Relay : Check the operating voltage between the white wire of the C1 connector and the sky wire of the CN14 connector. ➢ Normal: 120V (while operating) New PBA 3-1. Check the operation of the Fan Motor Relay : Check the operating voltage between the white wire of the C101 connector and the sky wire of the CN201 connector. ➢ Normal: 120V (while operating)	- Faulty: Replace the Main PBA assy. 
		4. Check the operation of the dispenser. ➢ If rinse aids are not dispensed, a dry error may occur. ➢ Because the dishes are heated and heat dried during the last drying cycle, the dried state of plastic dishes may not be optimal.	- See "Detergent is not dispensed"

Error type	Error mode	Checking Method	Corrective actions
Detergent is not dispensed.	None	1. Check whether detergent is inserted into the dispenser.	- Check whether there is detergent in the Dispenser.
		2. Check the connections for the Dispenser connector.	- Reconnect the Dispenser connector.
		3. Check the resistance of the Dispenser. (Remove the connector before measuring.) > Normal: Approx. 2.3 kΩ	- Faulty: Replace the Dispenser. 
		4. Check the operation of the Dispenser Relay: Check the operating voltage between the white wire of the CN1 connector and the white wire of the CN14 connector. > Normal: 120V (while operating) New PBA 4-1. Check the operation of the Dispenser Relay: Check the operating voltage between the white wire of the CN101 connector and the white wire of the CN201 connector. > Normal: 120V (while operating)	- Faulty: Replace the Main PBA assy. 

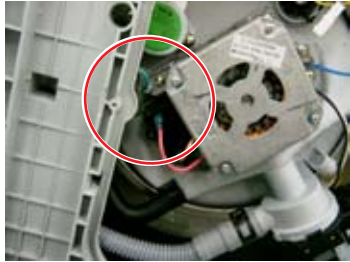
4. Troubleshooting

Error type	Error mode	Checking Method	Corrective actions
The nozzle does not inject water.	None	1. Check the connections for the Circulation Motor connector.	- Reconnect the Circulation Motor connector.
		2. Check the connections for the Startup Condenser connector of the Circulation Motor.	- Reconnect the Startup Condenser connector of the Circulation Motor. 
		3. Check the resistance for the Circulation Motor coil. (Remove the connector before measuring.) ➤ Normal: Approx. 16.5 Ω	- Faulty: Replace the Circulation Motor. 

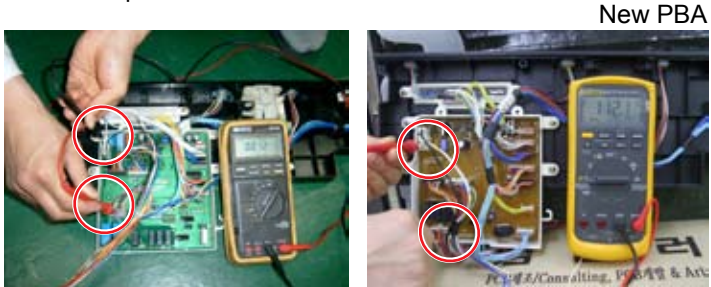
Error type	Error mode	Checking Method	Corrective actions
The nozzle does not inject water.	None	<p>4. Check the operation of the Circulation Motor Relay: Check the operating voltage between the white wire of the CN1 connector and the red wire of the CN14 connector on the Main PBA.</p> <p>➤ Normal: 120V (while operating)</p> <p>New PBA</p> <p>4-1. Check the operation of the Circulation Motor Relay: Check the operating voltage between the white wire of the CN101 connector and the red wire of the CN201 connector on the Main PBA.</p> <p>➤ Normal: 120V (while operating)</p>	<p>- Faulty: Replace the Main PBA assy. - Normal: Replace the Circulation Motor.</p> 
		5. Check the operation of the half load.	- See "PE Error".
		6. Check whether there is foreign material in the water passages.	- Remove foreign material from the water passages.
No washing	None	1. Check whether the nozzle injects water normally.	- See "The nozzle does not inject water".
		2. Check the operation of the half load.	- See "PE Error".
		3. Check the operation of the Heater.	- See "HE Error".

4. Troubleshooting

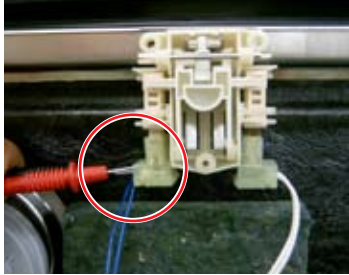
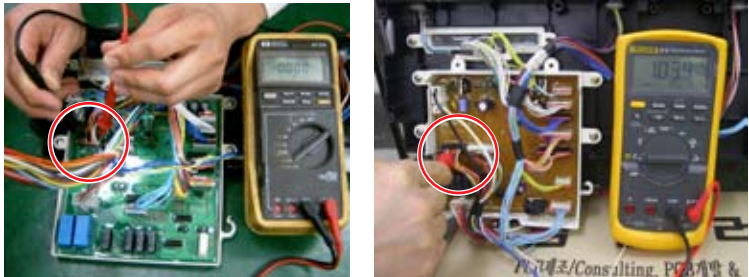
Error type	Error mode	Checking Method	Corrective actions
The cycle does not start.	None	<p>1. Check the connections for the Door Sensing Switch : Check the blue wire and the switch connected to the blue wire.</p> <ul style="list-style-type: none"> ➤ Normal: 4.5 to 5.5V (when the door is open) ➤ Normal: < 1V (when the door is closed) <p>New PBA</p> <p>1. Check the connections for the Door Sensing Switch : Check the blue wire and the switch connected to the blue wire.</p> <ul style="list-style-type: none"> ➤ Normal: 9.5 to 13.0V (when the door is open) ➤ Normal: < 1V (when the door is closed) 	<ul style="list-style-type: none"> - Reconnect the Door Sensing Switch connector. 
		<p>2. Check the operation of the Door Sensing Switch. (Remove the connector before measuring.) : Check the blue wire and the switch connected to the blue wire.</p> <ul style="list-style-type: none"> ➤ Normal: OPEN (when the door is open) ➤ Normal: SHORT (when the door is closed) 	<ul style="list-style-type: none"> - Faulty: Replace the Door Sensing Switch. - Normal: Replace the Main PBA assy.
Main PBA DC voltage error	None	<p>Check the DC voltage of the Main PBA.</p> <ul style="list-style-type: none"> - Measure the voltage between pin 6 (amber) of the main PBA CN7 connector and pin 7 (pink) of the CN7 connector. ➤ Normal: 4.5V to 5.5V - Measure the voltage between pin 6 (amber) of the main PBA CN7 connector and pin 9 (white) of the CN7 connector. ➤ Normal: 10.5V to 13.0V <p>New PBA</p> <p>Check the DC voltage of the Main PBA.</p> <ul style="list-style-type: none"> - Measure the voltage between pin 6 (amber) of the main PBA CN302 connector and pin 7 (pink) of the CN302 connector. ➤ Normal: 4.5V to 5.5V - Measure the voltage between pin 6 (amber) of the main PBA CN302 connector and pin 9 (white) of the CN302 connector. ➤ Normal: 9.5V to 13.0V 	<ul style="list-style-type: none"> - Faulty: Replace the Main PBA assy. 

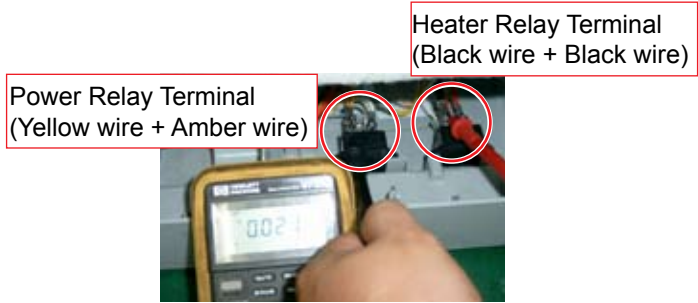
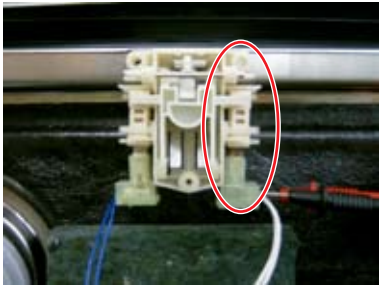
Error type	Error mode	Checking Method	Corrective actions
Power Relay error	None	<p>1. Check the connections for the Power Relay connector: : Start the cycle by pressing the Power key. Then measure the operating voltage between the black wires of the Heater Relay, and the operating voltage between the yellow and amber wires of the Power Relay.</p> <p>⚠ Caution Check the color of the wires of the Power Relay and the Heater Relay.</p> <p>➤ Normal: 120V</p>	<p>- Reconnect the Power Relay.</p> 
		<p>2. Check the door switch. : Check the white wire and the switch connected to the white wire.</p> <p>➤ When the door is open : The Door Switch is OFF.</p> <p>➤ When the door is closed : The Door Switch is ON.</p> <p>* The Power Relay and the Heater Relay use a 12V line. If the switch is out of order, the Power Relay and the Heater Relay will not operate.</p>	<p>- Faulty: Replace the Door Switch.</p> 

4. Troubleshooting

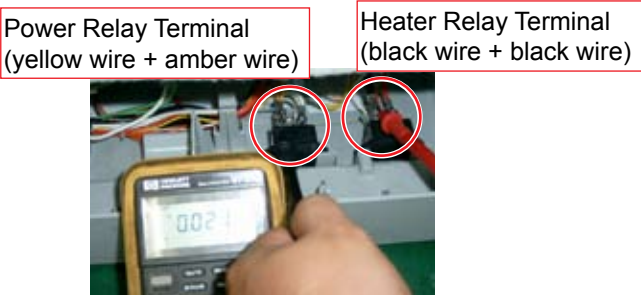
Error type	Error mode	Checking Method	Corrective actions
Power Relay error	None	<p>3. Check the driving signals for the power relay : Measure the voltage between pin 6 (amber) and pin 1 (black) of the CN7 connector on the main PBA.</p> <ul style="list-style-type: none"> > When the door is open or before the cycle starts. → Normal: 10.5 to 13 V > After the cycle has started by closing the door and pressing the Power key. → Normal: 1 V <p>New PBA</p> <p>3-1. Check the driving signals for the power relay : Measure the voltage between pin 6 (amber) and pin 1 (black) of the CN302 connector on the main PBA.</p> <ul style="list-style-type: none"> > When the door is open or before the cycle starts. → Normal: 9.5 to 13 V > After the cycle has started by closing the door and pressing the Power key. → Normal: 1 V 	<p>- Faulty: Replace the main PBA assy.</p> 
		<p>4. Check the operation of the Power Relay : Start the cycle by pressing the Power Key. Measure the operation voltage between the terminal (black wire + black wire) of the Heater Relay and the terminal (yellow wire + amber wire) of the Power Relay</p> <p>⚠ Caution Check the color of the wires of the Power Relay and the Heater Relay.</p> <ul style="list-style-type: none"> > Normal: 120V 	<p>- Faulty: Replace the power relay.</p> 

Memo

5. Exploded Views and Parts List

[Material Code Standards]

Material codes and names and their respective naming rules are managed in accordance with the prescribed standards.

Please refer to these standards when requesting a material.

1. Material Code Type

(●: Number, ■: Letter (Alphabet))

Type 1: ●●●●-●●●●●●●● ex) 0204-000418 FREON

Type 2: ■■●●-●●●●●■ ex) DD96-01390A ASSY-CONTROL

- ▶ Type 1: Enterprise-wide parts
Type 1 materials can be used for all Samsung Electronics products.
(Most electrical parts belong to this type.)
- ▶ Type 2: Division-wide parts (DD** - Dishwasher)
Type 2 materials can be used for specific products.
(Most instruments and tools belong to this type.)

2. Ass'y Materials

: All ass'y material codes start with DD9*.

An ass'y material is created by combining more than two materials. If a requested material cannot be provided, you can request an ass'y material that contains that material.

5-1. MAIN (DMR77, DMR78)

DMR77

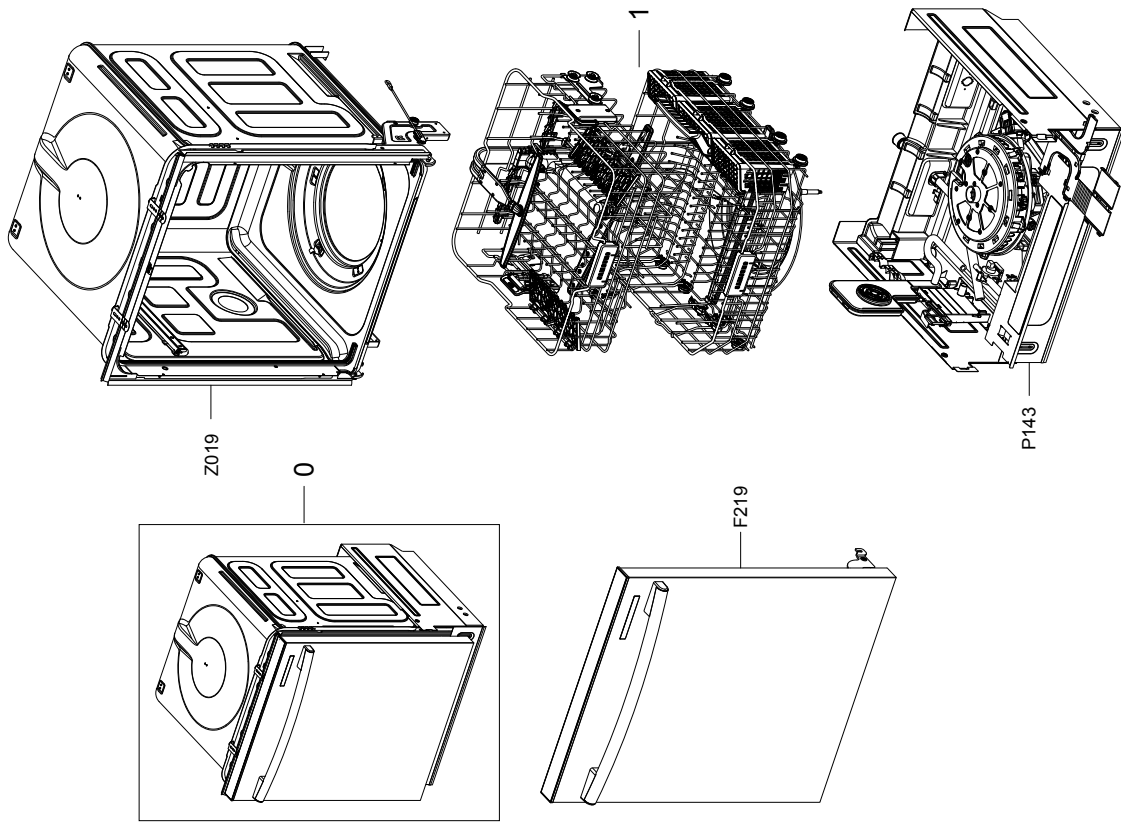

DMR78

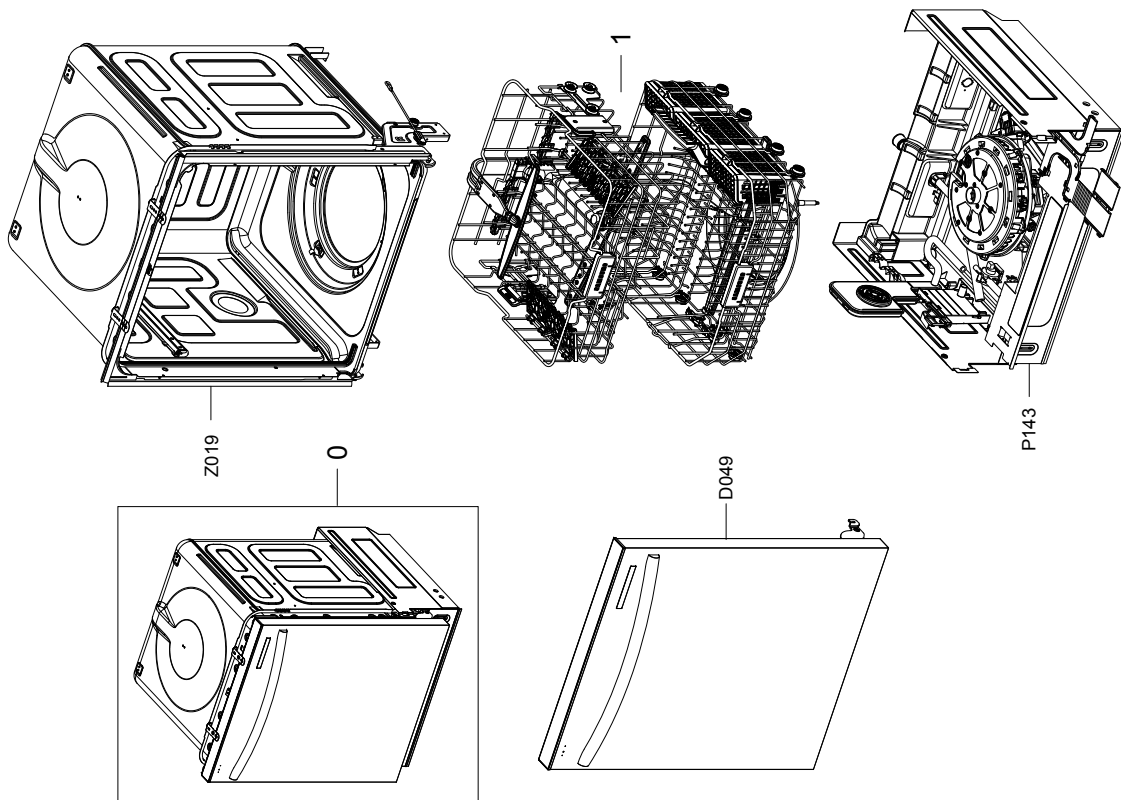

► **MODEL CODE: DMR77***, DMR78*****

Service Bom (SA: SERVICE AVAILABLE, SNA: SERVICE NOT AVAILABLE)

SVC_ Code	Code No.	Description	Specification	QTY	SA/SNA	Remark
5.1-0	DMR77LHS_XAA	SET		1		
5.1-0	DMR78AHS_ XAA	SET		1		
5.1-1	DD97-00108A	ASSY-CASE	DM1477,R-PJT	1	SNA	
P143	DD97-00110A	ASSY-BASE	DM1477,R-PJT	1	SNA	
F219	DD97-00103A	ASSY-DOOR	DM1477,R-PJT	1	SNA	DMR77LHS
D049	DD97-00139A	ASSY-DOOR	DMR77LHB,BLACK FRAME FRONT	1	SNA	DMR77LHB
D049	DD97-00140A	ASSY-DOOR	DMR77LHW,WHITE FRAME FRONT	1	SNA	DMR77LHW
D049	DD97-00103B	ASSY-DOOR	DMR78,-,R2-PJT	1	SNA	DMR78AHS
D049	DD97-00103C	ASSY-DOOR	DMR78AHB,R2-PJT	1	SNA	DMR78AHB
D049	DD97-00103D	ASSY-DOOR	DMR78AHW,R2-PJT	1	SNA	DMR78AHW
Z019	DD97-00113A	ASSY-TUB	DM1477,R-PJT	1	SNA	

5-2. ASSY-DOOR (DMR77, DMR78)

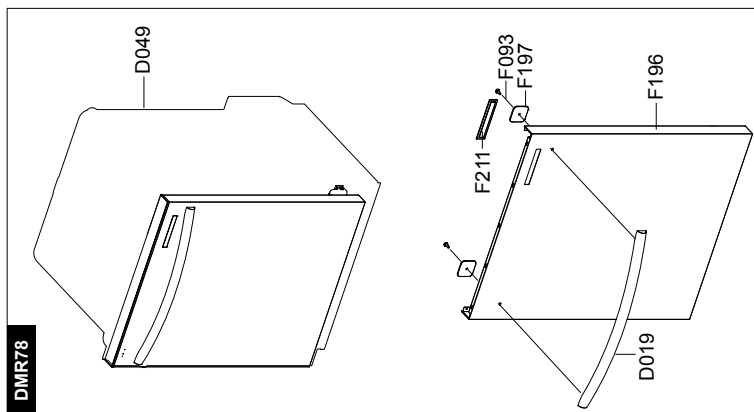
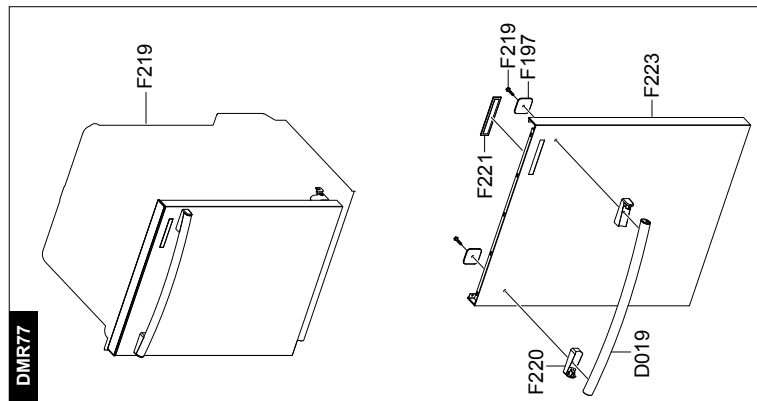
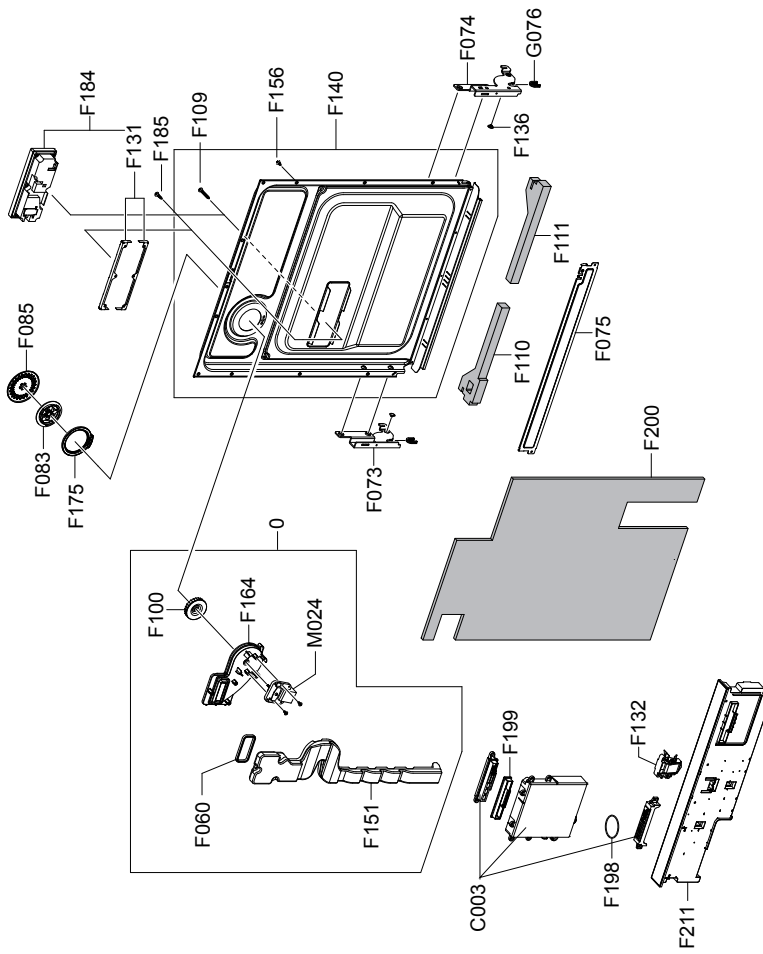

► **MODEL CODE: DMR77***, DMR78*****

Service Bom (SA: SERVICE AVAILABLE, SNA: SERVICE NOT AVAILABLE)

SVC_Code	Code No.	Description	Specification	QTY	SA/SNA	Remark
F110	DD63-00066A	CUSHION-DUCT(L)	DM1477,PU-FORM,-,-,-,-,R	1	SA	
F200	DD63-00059A	ABSORBER-SOUND(FRONT)	DM1477,FELT,T10,W5	1	SA	
F085	DD61-00203A	BRACKET-COVER FAN	DM1477,STS304,T0.5,-,-	1	SA	
F075	DD61-00205A	BRACKET-DOOR LINK	DM1477,GI,T0.8,-,-,-,R	1	SA	
F222	DD97-00104A	ASSY-PANEL CONTROL	DM1477,R-PJT/SIL	1	SA	
F111	DD63-00094A	CUSHION-DUCT(R)	DM1477,PU-FORM,-,-,-,-,R	1	SA	
F083	DD63-00065A	COVER-FAN	DM1477,POM,-,-,-,-,GRY,R-PJT	1	SA	
F219	DD97-00103A	ASSY-DOOR	DM1477,R-PJT	1	SNA	DMR77LHS
D049	DD97-00139A	ASSY-DOOR	DMR77LHB,BLACK FRAME FRONT	1	SNA	DMR77LHB
D049	DD97-00140A	ASSY-DOOR	DMR77LHW,WHITE FRAME FRONT	1	SNA	DMR77LHW
D049	DD97-00103B	ASSY-DOOR	DMR78,-,R2-PJT	1	SNA	DMR78AHS
D049	DD97-00103C	ASSY-DOOR	DMR78AHB,R2-PJT	1	SNA	DMR78AHB
D049	DD97-00103D	ASSY-DOOR	DMR78AHW,R2-PJT	1	SNA	DMR78AHW
F074	DD64-00046A	DOOR-LINK(R)	DM1477,EGI,T3.0,-,-,-,BLK,R	1	SA	
F073	DD64-00047A	DOOR-LINK(L)	DM1477,EGI,T3.0,-,-,-,BLK,R	1	SA	
D019	DD64-00043A	HANDLE-DOOR	DM1477,AL,T2.0,-,L572,-,-,R-PJT	1	SA	DMR77LHS
D019	DD64-00043B	HANDLE-DOOR	DMR77LHB,AL,T2.0,-,L572,-,BLK,R-PJT	1	SA	DMR77LHB
D019	DD64-00043C	HANDLE-DOOR	DMR77LHW,AL,T2.0,-,L572,-,WHT,R-PJT	1	SA	DMR77LHW
D019	DD64-00060A	HANDLE-DOOR	DMR78,STS430,1.0mm,-,-,-,-	1	SA	DMR78AHS
D019	DD64-00060B	HANDLE-DOOR	DMR78,STEEL,1.0mm,-,-,-,BLACK,-	1	SA	DMR78AHB
D019	DD64-00060C	HANDLE-DOOR	DMR78,STEEL,1.0mm,-,-,-,WHITE,-	1	SA	DMR78AHW
F100	DD67-00038A	FAN-VENT	DM1477,PP,-,-,-,R-PJT	1	SA	
F060	DD62-00049A	SEAL-VENT	DM1477,EPDM,BLK,-,-,-,R-PJT	1	SA	
F223	DD61-00201A	FRAME-FRONT	DM1477,STS304,-,-,-,T0.8,W601,L743,R-PJT	1	SA	DMR77LHS
F223	DD61-00201B	FRAME-FRONT	DMR77LHB,EGI,-,-,BLK,T0.8,w601,L743,R-PJT	1	SA	DMR77LHB
F223	DD61-00201C	FRAME-FRONT	DMR77LHW,EGI,-,-,BLK,T0.8,w601,L743,R-PJT	1	SA	DMR77LHW
F223	DD61-00201D	FRAME-FRONT	DMR78,STS430,-,-,-,0.8,601,743,R2-pjt	1	SA	DMR78AHS
F223	DD61-00201E	FRAME-FRONT	DMR78AHB,STS430,T0.8,W601,L743,R2-PJT	1	SA	DMR78AHB
F223	DD61-00201F	FRAME-FRONT	DMR78AHW,STS430,WHITE,T0.8,W601,L743,R2-PJT	1	SA	DMR78AHW
G076	DD61-00207A	GUIDE-DOOR LINK	DM1477,POM,-,-,-,WHT,R-P	2	SA	
F220	DD61-00200A	GUIDE-HANDLE	DM1477,ABS,-,-,-,BLK,R-PJT	2	SA	DMR77LHS
D032	DD61-00200B	GUIDE-HANDLE	DMR77LHB,ABS,-,-,-,BLK,R-PJT	2	SA	DMR77LHB
D032	DD61-00200C	GUIDE-HANDLE	DMR77LHW,ABS,-,-,-,WHT,R-PJT	2	SA	DMR77LHW
F197	DD61-00243A	HOLDER-BOLT	DM1477,MSWR,OD20,ID5.5,T2.0,	2	SA	
M024	DD31-00006A	MOTOR VENTILATION	-,DM1477,-,-,-,120V,30	1	SA	
F198	DD62-00045A	SEAL-GUIDE LED	DM1477,EPDM,BLK,-,-,-,R-P	1	SA	
F199	DD62-00047A	SEAL-GUIDE LED(F)	DM1477,EPDM,BLK,-,-,-,	1	SA	
F175	DD62-00044A	SEAL-FAN	DM1477,EPDM,BLK,-,-,-,R-PJT	1	SA	
F136	DD60-00001A	SPACER-DOOR LINK	DM1477,POM,-,-,-,WHT,-,	2	SA	
F132	DD34-00002B	SWITCH DOOR-LOCK	-,Normal open,-,125VAC/	1	SA	
F140	DD97-00106A	ASSY-TUB FRONT	DM1475,R-PJT	1	SA	
F151	DD67-00037A	DUCT-CONDENSER	DM1477,PP,-,-,-,BLK,R-PJT	1	SA	
F219	6011-001640	BOLT-HEX	M5,L45,ZPC(YEL),SWRCH18A,-	2	SA	DMR77series
F093	6011-001805	BOLT-HEX	M5,L15,ZPC(YEL),SWRCH18A,-	2	SA	DMR78series
F221	DD64-00041A	WINDOW-PANEL FRONT	DM1477,PC,-,-,-,-,CLE	1	SA	
F184	DD59-01001A	DISPENSER-RINSE -AID	100418,-,-,120V/60H	1	SA	
F131	DD61-00103A	BRACKET-DISPENSOR	SDW-H120,GI,T0.8,-,-,-	2	SA	
5.2-0	DD97-00107A	ASSY-CONDENSING	DM1477,R-PJT	1	SNA	
F164	DD97-00147A	ASSY-CASE VENT	DMR77LHS,R-PJT	1	SA	
F156	DD81-01151A	SCREW-DOOR(S)	DMR,SUSXM7,T20,4x17,672000	8	SA	
F185	DD81-01152A	SCREW-DOOR(M)	DMR,SUSXM7,T20,4x25,672000	2	SA	
F109	DD81-01153A	SCREW-DOOR(L)	DMR,SUSXM7,T20,4x41,672000	2	SA	
C003	DD92-00008A	ASSY PCB	DMR,LED,-,-,HIDDEN,-,-,-,-	1	SA	

5-3. ASSY-TUB (DMR77, DMR78)

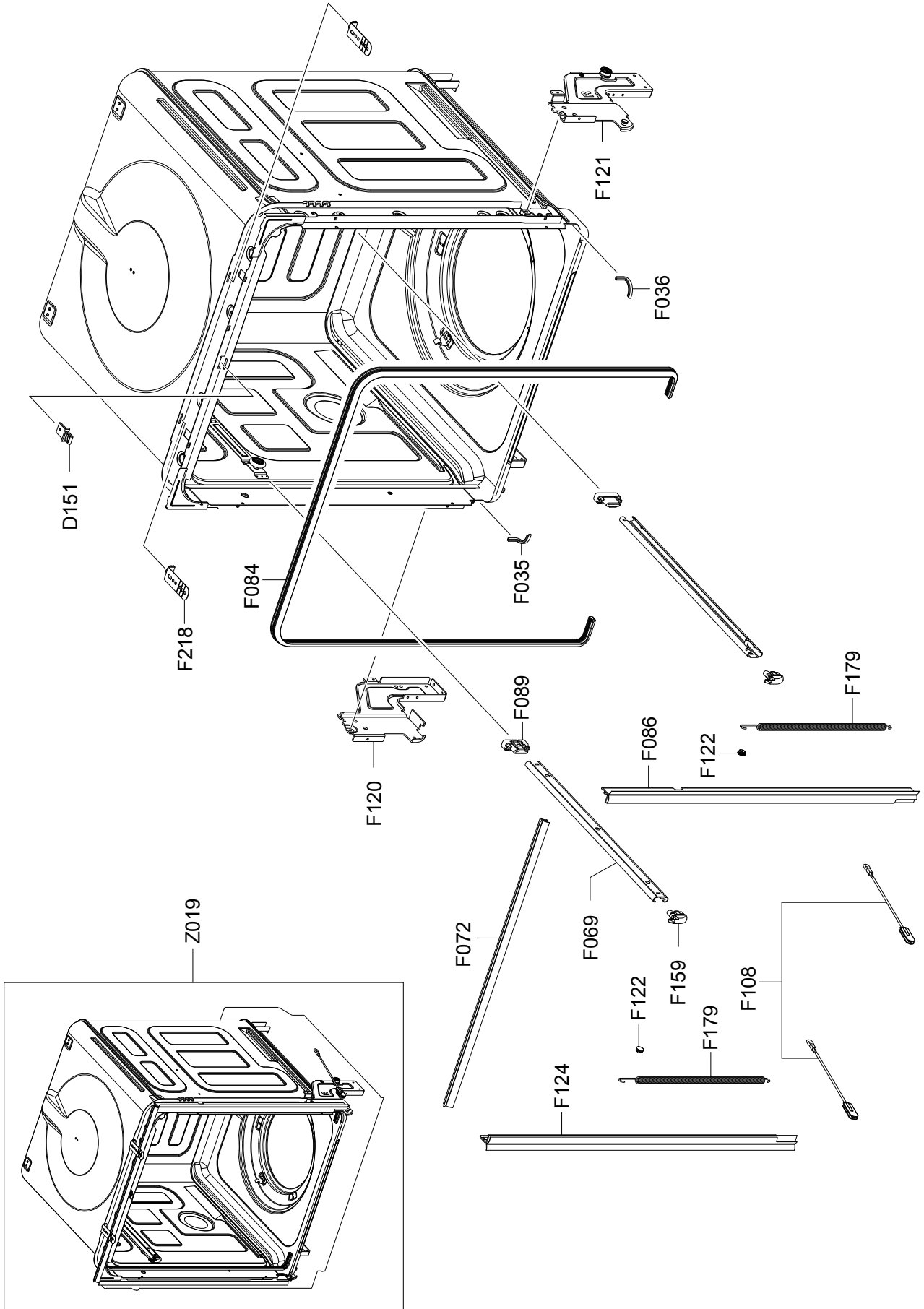

► **MODEL CODE: DMR77***, DMR78*****

Service Bom (SA: SERVICE AVAILABLE, SNA: SERVICE NOT AVAILABLE)

SVC_ Code	Code No.	Description	Specification	QTY	SA/SNA	Remark
F121	DD97-00114A	ASSY-SUPPORT LINK(R)	DM1477,R-PJT	1	SA	
F120	DD97-00115A	ASSY-SUPPORT LINK(L)	DM1477,R-PJT	1	SA	
P218	DD61-00176A	BRACKET-INSTALL	DM1477,GI,T0.8,-,-,-,R-P	2	SA	
F122	DD67-00040A	CAP-TUB SPACER	DM1477,POM,-,-,-,GRY,R-PJ	2	SA	
F036	DD61-00177A	GUIDE-TUB EDGE(R)	DM1477,PP+T20%,-,-,-,G	1	SA	
F035	DD61-00178A	GUIDE-TUB EDGE(L)	DM1477,PP+T20%,-,-,-,G	1	SA	
D151	DD61-00175A	HOLDER-DOOR LOCK	DM1477,AL,-,-,-,-,R-PJT	1	SA	
F086	DD69-00015A	PACKING-NOISE SIDE(R)	DM1477,PVC,-,-,-,-	1	SA	
F124	DD69-00016A	PACKING-NOISE SIDE(L)	DM1477,PVC,-,-,-,-	1	SA	
F072	DD69-00014A	PACKING-NOISE TOP	DM1477,PVC,-,-,-,-,B	1	SA	
F069	DD61-00174A	RAIL-BASKET	DM1477,STS304,T0.8,-,-,-,R-P	2	SA	
F108	DD67-00039A	ROPE-DOOR SPRING	DM1477,POM/POLYESTER/S2	2	SA	
F084	DD62-00043A	SEAL-TUB FRONT	DM1477,EPDM,BLK,-,-,-,R-P	1	SA	
F159	DD61-00182A	STOPPER-RAIL(F)	DM1477,POM,-,-,-,GRAY,R-	2	SA	
F089	DD61-00183A	STOPPER-RAIL(R)	DM1477,POM,-,-,-,GRAY,R-	2	SA	
F179	DD61-00245A	SPRING ETC	DM1477,PWR,-,-,-,-,-,R-	2	SA	
Z019	DD97-00113A	ASSY-TUB	DM1477,R-PJT	1	SNA	

5-4. ASSY-BASE (DMR77, DMR78)

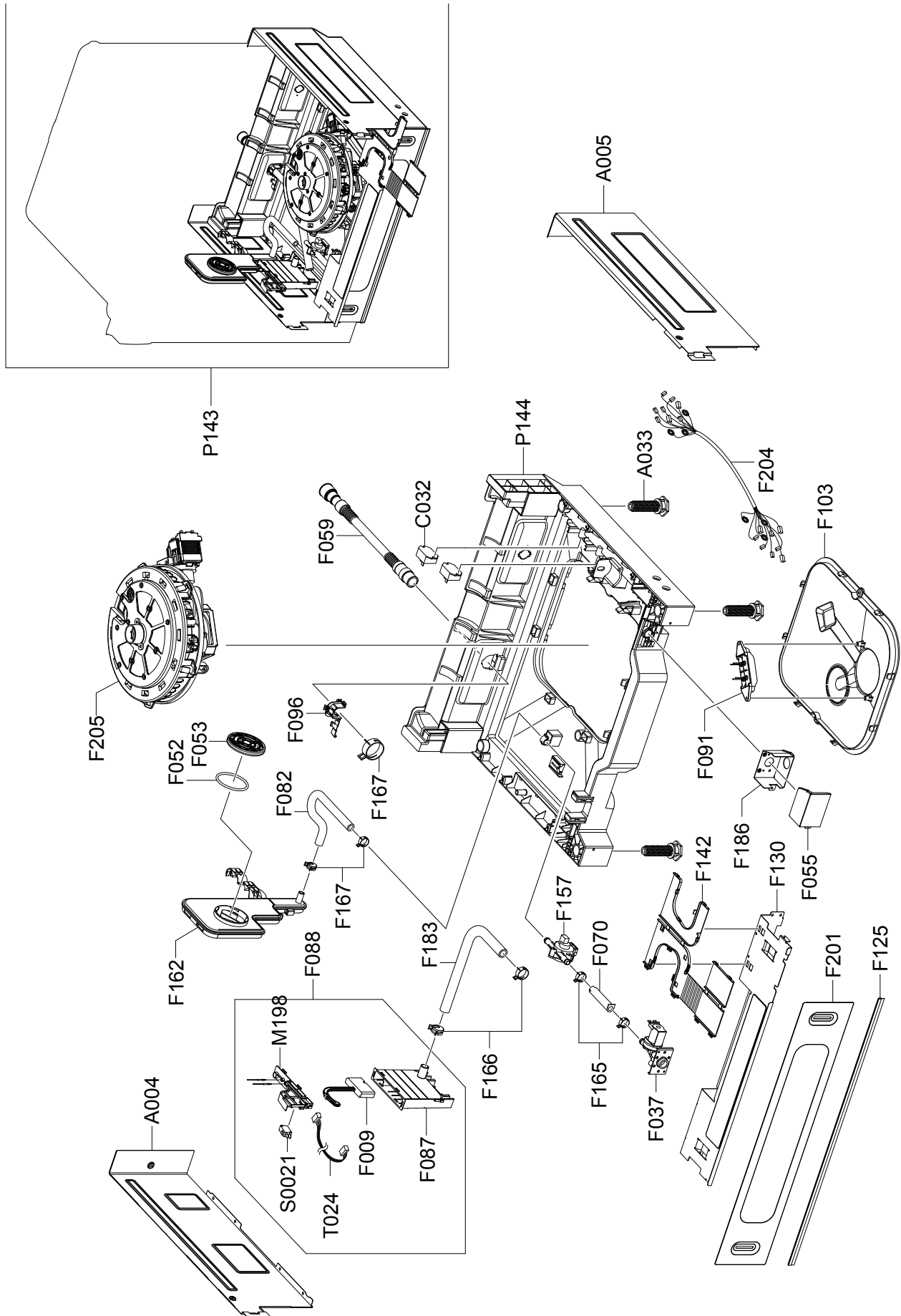

► **MODEL CODE: DMR77***, DMR78*****

Service Bom (SA: SERVICE AVAILABLE, SNA: SERVICE NOT AVAILABLE)

SVC_Code	Code No.	Description	Specification	QTY	SA/SNA	Remark
F091	DD97-00130A	ASSY-SENSOR LEAK	DM1477,R-PJT	1	SA	
F088	DD97-00131A	ASSY-SENSOR LEVEL	DM1477,R-PJT	1	SA	
F103	DD64-00055A	SHUTTER	DM1477,PP,-,-,-,WHT,R-PJT	1	SA	
P143	DD97-00110A	ASSY-BASE	DM1477,R-PJT	1	SNA	
F162	DD97-00132A	ASSY-CASE BRAKE	DM1477,R-PJT	1	SA	
A033	DD61-00232A	LEG-ADJUST	DM1477,PA,-,GRY,-,R-PJT	4	SA	
P144	DD61-00233A	BASE	DM1477,PP,-,-,-,GRY,R-PJT	1	SA	
F186	DD61-00229A	CASE-POWER CORD	DM1477,GI,T1.0,-,-,-,R-P	1	SA	
F167	DD65-00001G	CLAMPER HOSE	DM1477,SK5M,-,ID23.7,-,R-PJ	1	SA	
F166	DD65-00001H	CLAMPER HOSE	DM1477,SK5M,-,D19,-,R-PJT	2	SA	
F165	DD65-00001J	CLAMPER HOSE	DM1477,SK5M,-,D16,-,R-PJT	4	SA	
F053	DD63-00073A	COVER-BRAKE	DM1477,PP+T20%,-,-,-,-,GRY	1	SA	
S0021	DD34-00003A	SWITCH-MICRO	VX-01-1C22,NORMAL OPEN,-,-,	1	SA	
F055	DD63-00082A	COVER-POWER CORD	DM1477,GI,T0.8,-,-,-,-,	1	SA	
A004	DD61-00208A	FRAME-LEFT	DM1477,EGI,-,-,BLK,T0.7,-,-,R	1	SA	
A005	DD61-00209A	FRAME-RIGHT	DM1477,EGI,-,-,BLK,T0.7,-,-,	1	SA	
F096	DD61-00230A	HOLDER-HOSE DRAIN	DM1477,POM,-,-,-,-,R-P	1	SA	
F059	DD97-00137A	ASSY-HOSE DRAIN	DM1477,R-PJT/VANE-CHECK	1	SA	
F070	DD67-00045A	HOSE-INLET	DM1477,EPDM,-,-,-,-,BLK,R-PJT	1	SA	
F009	DD66-00034A	LEVER-FLOAT	DM1477,PP+T20%,-,-,-,-,-,R-P	1	SA	
F157	DD32-00004A	SENSOR-FLOW	GSGTSD1,DM1477,-,5VDC,-,-,-,-,	1	SA	
F142	DD61-00234A	GUIDE-WIRE	DM1477,PP,-,-,-,-,R-PJT	1	SA	
T024	DD96-00043A	ASSY-WIRE HARNESS	DM1477/DM1475,OVER FLO	1	SA	
F204	DD96-00038A	ASSY-M.WIRE HARNESS	DM1477,HIDDEN TYPE	1	SA	
F037	DD62-00067A	VALVE-WATER	DM1477,PP,120V,-,-,-,-	1	SA	
C032	3501-000260	RELAY-POWER	12V,4400VA,20000MA,-,20MS,10	2	SA	
F125	DD69-00017A	PACKING-NOISE BASE	DM1477,PVC,-,-,-,-,-,	1	SA	
F130	DD61-00231A	BRACKET-FRONT LOWER	DM1477,GI,T1.0,-,-,-,-	1	SA	
F082	DD67-00046A	HOSE-INLET FLOW	DM1477,EPDM,-,-,-,-,BLK,	1	SA	
F183	DD67-00047A	HOSE-SENSOR	DM1477,EPDM,-,-,-,-,BLK,R-PJ	1	SA	
F205	DD97-00111A	ASSY-SUMP	DM1477,R-PJT	1	SA	
F087	DD61-00236A	CASE-SENSOR	DM1477,PP,-,-,-,-,R-PJT	1	SA	
M198	DD63-00083A	COVER-SENSOR	DM1477,PP+T20%,-,-,-,-,-,	1	SA	
F201	DD63-00081A	COVER-FRONT LOWER	DM1477,EGI,T0.5,-,-,-,-,-,R-PJT	1	SA	DMR78AHS, DMR77LHS
F213	DD63-00081B	COVER-FRONT LOWER	DMR77LHB,EGI,T0.5,-,-,-,-,-,BLK,R-PJT	1	SA	DMR77LHB, DMR78AHB
F148	DD63-00081C	COVER-FRONT LOWER	DMR77LHW,EGI,T0.5,-,-,-,-,-,WHT,R-PJT	1	SA	DMR77LHW, DMR78AHW
F052	DD63-00072A	GASKET-BRAKE	DM1477,EPDM,-,-,-,-,BLK,-,R-P	1	SA	
M019	3601-000438	FUSE-CARTRIDGE	250V,15A,SLOW-BLOW,CERAMIC,6.35x31.8mm	1	SA	

5-5. ASSY-SUMP (DMR77, DMR78)

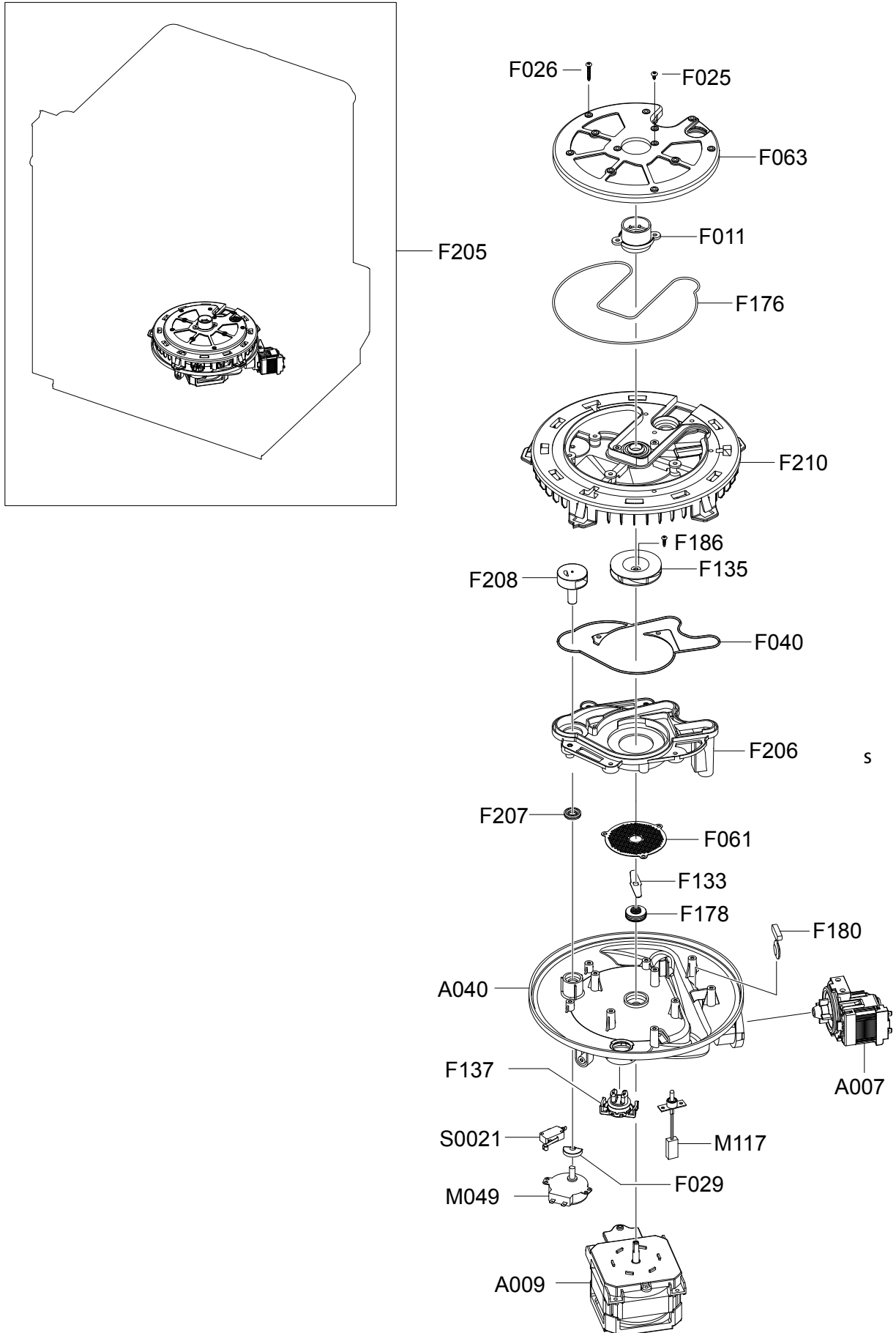

► **MODEL CODE: DMR77***, DMR78*****

Service Bom (SA: SERVICE AVAILABLE, SNA: SERVICE NOT AVAILABLE)

SVC Code	Code No.	Description	Specification	QTY	SA/SNA	Remark
F063	DD97-00133A	ASSY-FILTER MESH	DM1477,R-PJT	1	SA	
F135	DD97-00136A	ASSY-IMPELLER	DM1477,R-PJT	1	SA	
F210	DD97-00134A	ASSY-COVER SUMP	DM1477,R-PJT	1	SA	
F209	DD66-00035A	CAM-SWITCH	DM1477,POM,-,-,-,-,R-PJT	1	SA	
F206	DD61-00240A	CASE-SCROLL	DM1477,PP+T20%,-,-,-,-,R-PJT	1	SA	
S0021	DD34-00004A	SWITCH-MICRO	D3V-016-3C23,NORMAL OPEN,-,	1	SA	
F061	DD63-00087A	FILTER-CIRCULATION	DM1477,STS304,T0.8,-,	1	SA	
F011	DD61-00241A	HOLDER-NOZZLE(L)	DM1477,POM,-,-,-,BLU,R-	1	SA	
A007	DD31-00005A	PUMP-DRAIN	-,120V,60Hz,-,45W/R-PJT	1	SA	
A009	DD31-00004A	PUMP-CIRCULATION	-,120V,60Hz,-,3450rpm/9	1	SA	
A040	DD61-00239A	CASE-SUMP	DM1477,PP+T20%,-,-,-,-,R-PJT	1	SA	
M049	DD31-00007A	MOTOR SYNCHRONOUS	GM-16-12L13,DM1477,-,-	1	SA	
F040	DD62-00055A	SEAL-RUBBER SCROLL	DM1477,EPDM,BLK,-,-,-	1	SA	
F207	DD62-00054A	SEAL-DISTRIBUTER	DM1477,EPDM,BLK,-,-,-,R	1	SA	
F176	DD62-00052A	SEAL-FILTER MESH	DM1477,EPDM,BLK,-,-,-,R	1	SA	
F137	DD32-00003A	SENSOR-TURBIDITY	GSGTSD1,DM1477,-,120V,-	1	SA	
F178	DD62-00053A	SEAL-OIL	DM1477,NBR,BLK,-,-,-,R-PJT	1	SA	
F180	DD66-00019A	VANE-CHECK DRAIN	DM1477,EPDM,-,-,BLK,R-P	1	SA	
F208	DD62-00066A	VALVE-DISTRIBUTER	DM1477,POM,-,-,-,-,R-PJT	1	SA	
M117	DD32-00001A	THERMISTOR	PTM-K51F-S14,3.3K,-,0~100°C,-	1	SA	
F205	DD97-00111A	ASSY-SUMP	DM1477,R-PJT	1	SA	
F133	DD70-01001A	CUTTER-DISPOSER	DM1477,STS304,T1.0,-,-,-	1	SA	
F026	DD81-01149A	SCREW-SUMP(S)	DMR,SUSXM7,+TH,4x20,672000	2	SA	
F025	DD81-01150A	SCREW-SUMP(L)	DMR,SUSXM7,+TH,4x56,672000	11	SA	
F186	DD81-01172A	SCREW-MOTOR IMPELLER	DMR,SUS304,+TH,4*12	1	SA	

5-6. ASSY-CASE (DMR77, DMR78)

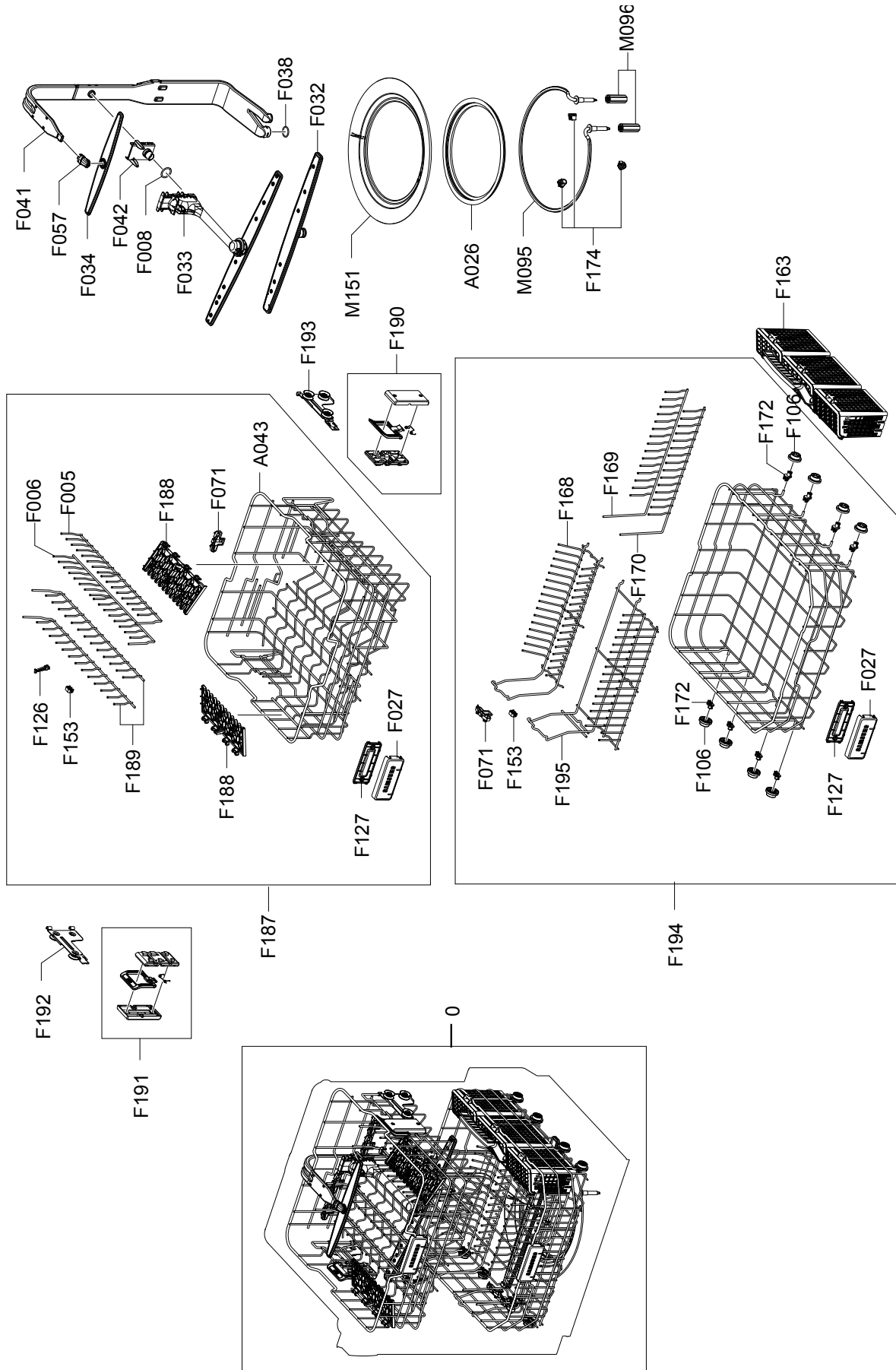

► **MODEL CODE: DMR77***, DMR78*****

Service Bom (SA: SERVICE AVAILABLE, SNA: SERVICE NOT AVAILABLE)

SVC_Code	Code No.	Description	Specification	QTY	SA/SNA	Remark
5.6-0	DD97-00108A	ASSY-CASE	DM1477,R-PJT	1	SNA	
F192	DD97-00121A	ASSY-BRACKET ADJUSTER(L)	DM1477,R-PJT	1	SA	
F193	DD97-00122A	ASSY-BRACKET ADJUSTER(R)	DM1477,R-PJT	1	SA	
F190	DD97-00119A	ASSY-BASKET ADJUSTER(R)	DM1477,R-PJT	1	SA	
F191	DD97-00120A	ASSY-BASKET ADJUSTER(L)	DM1477,R-PJT	1	SA	
F163	DD97-00125A	ASSY-CASE SPOON	DM1477,R-PJT	1	SA	
A043	DD61-00179A	BASKET-UPPER	DM1477,HSWR,-,-,NYLON-COA	1	SA	
F041	DD67-00041A	DUCT-NOZZLE	DM1477,PP,-,-,GRY,R-PJT	1	SA	
F127	DD64-00057A	HANDLE-BASKET(L)	DMR77LHS,PP+T20%,-,-,	1	SA	
F027	DD64-00058A	HANDLE-BASKET(U)	DMR77LHS,PP+T20%,-,-,	1	SA	
F187	DD97-00117A	ASSY-BASKET UPPER	DM1477,R-PJT	1	SA	
F034	DD97-00127A	ASSY-NOZZLE(U)	DM1477,R-PJT	1	SA	
F032	DD97-00128A	ASSY-NOZZLE(L)	DM1477,R-PJT	1	SA	
F033	DD97-00126A	ASSY-NOZZLE(M)	DM1477,R-PJT	1	SA	
A026	DD62-00050A	SEAL-SUMP	DM1477,EPDM,BLK,-,-,R-PJT	1	SA	
F194	DD97-00123A	ASSY-BASKET LOWER	DM1477,R-PJT	1	SA	
F008	DD69-00019A	PACKING-DUCT	DM1477,EPDM,O-RING,-,-,-,	1	SA	
M095	DD47-00003A	HEATER	-R-PJT,INCLOY800,1100W,0.75mA	1	SA	
M151	DD63-00071A	COVER-HEATER	DM1477,STS304,T0.5,-,-,-,	1	SA	
M096	DD61-00211A	HOLDER-HEATER	DM1477,PA+GF25%,-,-,-R-	2	SA	
F174	DD61-00212A	HOLDER-SUMP	DM1477,POM,-,-,-,R-PJT	3	SA	
F057	DD61-00228A	HOLDER-NOZZLE(U)	DM1477,POM,-,-,-,GRY,R-	1	SA	
F038	DD62-00068A	SEAL-DUCT NOZZLE	DMR77LHS,EPDM,BLK,T2.3,	1	SA	
F042	DD63-00069A	COVER-DUCT NOZZLE	DM1477,POM,-,-,-,G	1	SA	
F071	DD61-00216A	HOLDER-TINE	DM1477,POM,-,-,-,BLU,R-PJT	4	SA	
F153	DD61-00217A	HOLDER-TINE(S)	DM1477,POM,-,-,-,BLU,R-PJ	8	SA	
F188	DD61-00218A	SUPPORT-CUP	DM1477,POM,-,-,-,BLU,R-PJT	2	SA	
F126	DD61-00219A	CLIP-CUP	DM1477,POM,-,BLU,R-PJT	4	SA	
F005	DD66-00026A	WIRE-TINE UPPER(L)	DM1477,HSWR,-,-,R-PJT	1	SA	
F006	DD66-00027A	WIRE-TINE UPPER(R)	DM1477,HSWR,-,-,R-PJT	1	SA	
F189	DD66-00028A	WIRE-TINE UPPER(S)	DM1477,HSWR,-,-,R-PJT	2	SA	
A041	DD61-00215A	BASKET-LOWER	DM1477,HSWR,-,-,NYLON-COA	1	SA	
F071	DD61-00216A	HOLDER-TINE	DM1477,POM,-,-,-,BLU,R-PJT	2	SA	
F153	DD61-00217A	HOLDER-TINE(S)	DM1477,POM,-,-,-,BLU,R-PJ	4	SA	
F172	DD61-00222A	HOLDER-ROLLER	DM1477,PA,-,-,-,GRA,R-PJT	8	SA	
F106	DD66-00023A	ROLLER-BASKET(L)	DM1477,POM,-,-,GRY,-,R-	8	SA	
F195	DD66-00029A	WIRE-TINE LOWER(F)	DM1477,HSWR,-,-,R-PJT	1	SA	
F168	DD66-00030A	WIRE-TINE LOWER(B)	DM1477,HSWR,-,-,R-PJT	1	SA	
F170	DD66-00031A	WIRE-TINE LOWER(R)	DM1477,HSWR,-,-,R-PJT	1	SA	
F169	DD66-00032A	WIRE-TINE LOWER(L)	DM1477,HSWR,-,-,R-PJT	1	SA	

5-7. MAIN (DMR57)

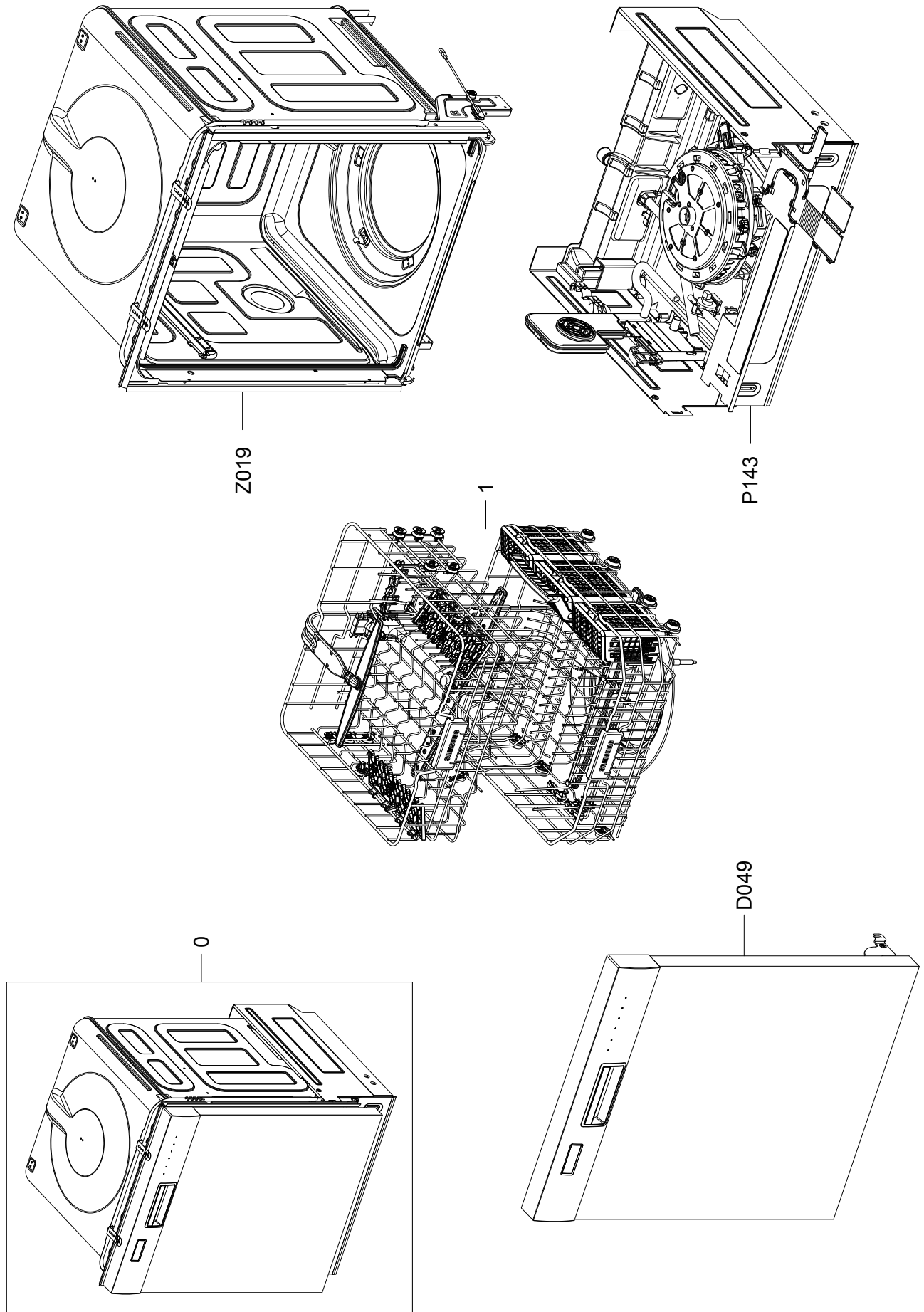

► **MODEL CODE: DMR57LF***

Service Bom (SA: SERVICE AVAILABLE, SNA: SERVICE NOT AVAILABLE)

SVC_ Code	Code No.	Description	Specification	QTY	SA/SNA	Remark
5.7-0	DMR57LFS_XAA	SET		1		
5.7-1	DD97-00109A	ASSY-CASE	DM1475,R-PJT/BETTER	1	SNA	
P143	DD97-00138A	ASSY-BASE	DM1475,R-PJT/BETTER	1	SNA	
D049	DD97-00112A	ASSY-DOOR	DM1475,R-PJT/BETTER	1	SNA	DMR57LFS
D049	DD97-00141A	ASSY-DOOR	DMR57LFB,BLACK FRAME FRONT	1	SNA	DMR57LFB
D049	DD97-00142A	ASSY-DOOR	DMR57LFW,WHITE FRAME FRONT	1	SNA	DMR57LFW
Z019	DD97-00113A	ASSY-TUB	DM1477,R-PJT	1	SNA	

5-8. ASSY-DOOR (DMR57)

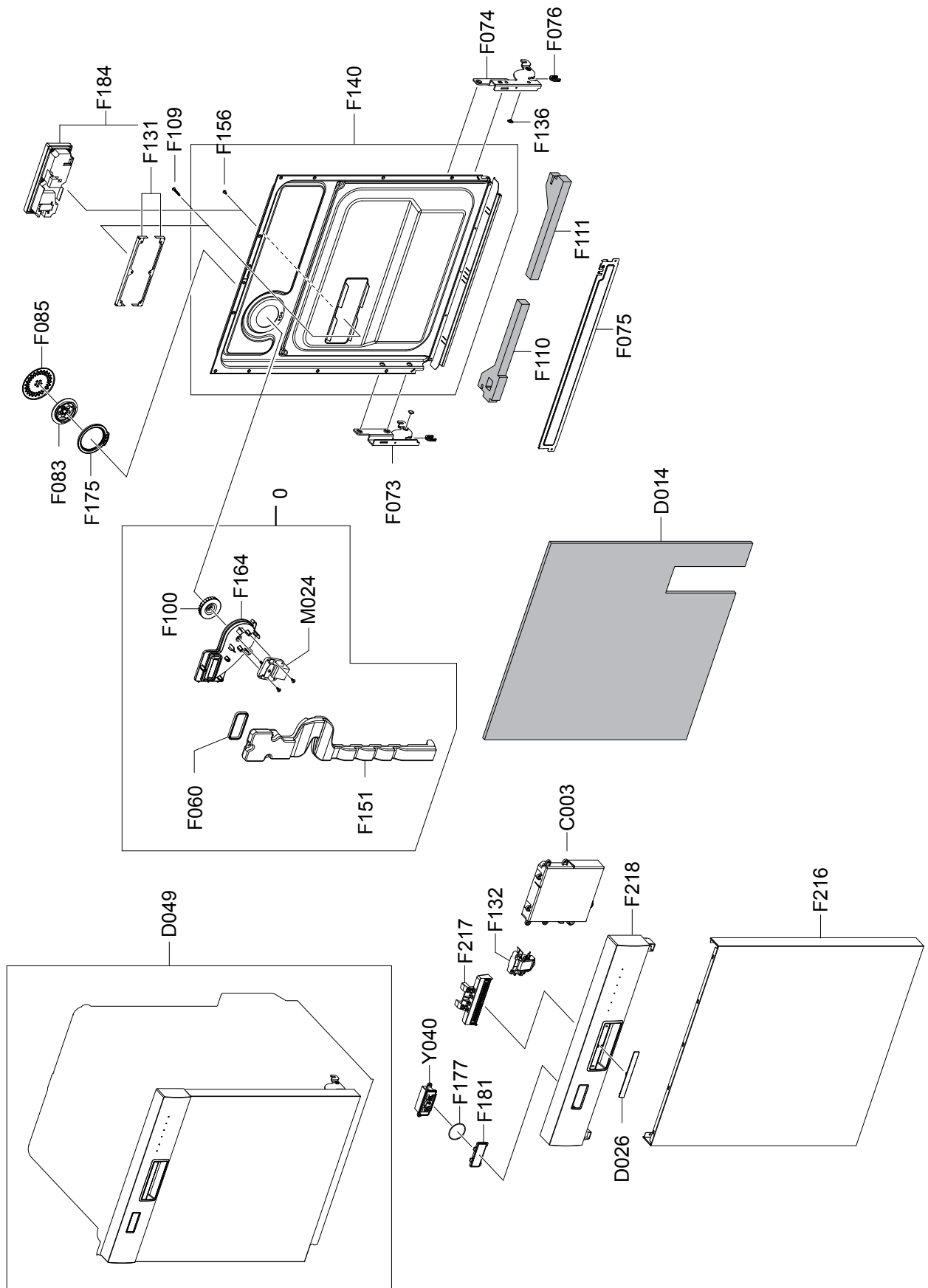

► **MODEL CODE: DMR57LF***

Service Bom (SA: SERVICE AVAILABLE, SNA: SERVICE NOT AVAILABLE)

SVC_Code	Code No.	Description	Specification	QTY	SA/SNA	
F110	DD63-00066A	CUSHION-DUCT(L)	DM1477,PU-FORM,-,-,-,R	1	SA	
F014	DD63-00092A	ABSORBER-SOUND(FRONT)	DM1475,FELT,T10,W5	1	SA	
F085	DD61-00203A	BRACKET-COVER FAN	DM1477,STS304,T0.5,-,-	1	SA	
F075	DD61-00205A	BRACKET-DOOR LINK	DM1477,GI,T0.8,-,-,-,R	1	SA	
F218	DD97-00105A	ASSY-PANEL CONTROL	DM1475,R-PJT/SIL	1	SA	DMR57LFS
F215	DD97-00105B	ASSY-PANEL CONTROL	DMR57LFB,R-PJT/BLK	1	SA	DMR57LFB
F095	DD97-00105C	ASSY-PANEL CONTROL	DMR57LFW,R-PJT/WHT	1	SA	DMR57LFW
Y040	DD07-00010A	LED DISPLAY	CSV-25005B7,DM1475,-,7,3,68*	1	SA	
F111	DD63-00094A	CUSHION-DUCT(R)	DM1477,PU-FORM,-,-,-,R	1	SA	
F083	DD63-00065A	COVER-FAN	DM1477,POM,-,-,-,-,GRY,R-PJT	1	SA	
D049	DD97-00112A	ASSY-DOOR	DM1475,R-PJT/BETTER	1	SNA	DMR57LFS
D049	DD97-00141A	ASSY-DOOR	DMR57LFB,BLACK FRAME FRONT	1	SNA	DMR57LFB
D049	DD97-00142A	ASSY-DOOR	DMR57LFW,WHITE FRAME FRONT	1	SNA	DMR57LFW
F074	DD64-00046A	DOOR-LINK(R)	DM1477,EGI,T3.0,-,-,-,BLK,R	1	SA	
F073	DD64-00047A	DOOR-LINK(L)	DM1477,EGI,T3.0,-,-,-,BLK,R	1	SA	
F100	DD67-00038A	FAN-VENT	DM1477,PP,-,-,-,R-PJT	1	SA	
F060	DD62-00049A	SEAL-VENT	DM1477,EPDM,BLK,-,-,-,R-PJT	1	SA	
F216	DD61-00202A	FRAME-FRONT	DM1475,STS304,-,-,-,T0.8,W601,L640,R-PJT/BETTER	1	SA	DMR57LFS
F212	DD61-00202B	FRAME-FRONT	DMR57LFB,EGI,-,-,BLK,T0.8,W601,L640,R-PJT	1	SA	DMR57LFB
F149	DD61-00202C	FRAME-FRONT	DMR57LFW,EGI,-,-,WHT,T0.8,W601,L640,R-PJT	1	SA	DMR57LFW
F076	DD61-00207A	GUIDE-DOOR LINK	DM1477,POM,-,-,-,WHT,R-P	2	SA	
M024	DD31-00006A	MOTOR VENTILATION	-,DM1477,-,-,-,120V,30	1	SA	
D026	DD63-00088A	COVER-HANDLE	DM1475,ABS,-,-,-,-,Cr-COAT,R-PJT/BETTER	1	SA	DMR57LFS
D026	DD63-00088B	COVER-HANDLE	DMR57LFB,ABS,-,-,-,-,BLK,R-PJT/BETTER	1	SA	DMR57LFB
D026	DD63-00088A	COVER-HANDLE	DM1475,ABS,-,-,-,-,Cr-COAT,R-PJT/BETTER	1	SA	DMR57LFW
F175	DD62-00044A	SEAL-FAN	DM1477,EPDM,BLK,-,-,-,R-PJT	1	SA	
F136	DD60-00001A	SPACER-DOOR LINK	DM1477,POM,-,-,-,WHT,-,	2	SA	
F132	DD34-00002B	SWITCH DOOR-LOCK	-,Normal open,-,125VAC/	1	SA	
F140	DD97-00106A	ASSY-TUB FRONT	DM1475,R-PJT	1	SA	
F151	DD67-00037A	DUCT-CONDENSER	DM1477,PP,-,-,-,BLK,R-PJT	1	SA	
F181	DD64-00044A	WINDOW-PANEL FRONT	DM1475,PC,-,-,-,-,CLE	1	SA	
F184	DD59-01001A	DISPENSER-RINSE -AID	100418,-,-,120V/60H	1	SA	
F131	DD61-00103A	BRACKET-DISPENSOR	SDW-H120,GI,T0.8,-,-,-	2	SA	
5.8-0	DD97-00107A	ASSY-CONDENSING	DM1477,R-PJT	1	SNA	
F164	DD97-00147A	ASSY-CASE VENT	DMR77LHS,R-PJT	1	SA	
F177	DD62-00057A	SEAL-LED DISPLAY	DM1475,EPDM,BLK,-,-,-,R	1	SA	
F217	DD64-00056A	HANDLE-FRONT	DM1475,ABS,-,-,-,-,BLK,R-PJT/BETTER	1	SA	DMR57LFS
F214	DD64-00056B	HANDLE-FRONT	DMR57LFB,ABS,-,-,-,-,BLK,R-PJT	1	SA	DMR57LFB
F028	DD64-00056C	HANDLE-FRONT	DMR57LFW,ABS,-,-,-,-,WHT,R-PJT	1	SA	DMR57LFW
F156	DD81-01151A	SCREW-DOOR(S)	DMR,SUSXM7,T20,4x17,672000	8	SA	
F185	DD81-01152A	SCREW-DOOR(M)	DMR,SUSXM7,T20,4x25,672000	2	SA	
F109	DD81-01153A	SCREW-DOOR(L)	DMR,SUSXM7,T20,4x41,672000	2	SA	
C003	DE92-02130B	ASSY PCB	DAM-RVE-01,DMR57,LED DISPLAY,12	1	SA	
F156	DD81-01151A	SCREW-DOOR(S)	DMR,SUSXM7,T20,4x17,672000	10	SA	
F109	DD81-01153A	SCREW-DOOR(L)	DMR,SUSXM7,T20,4x41,672000	2	SA	

5-9. ASSY-TUB (DMR57)

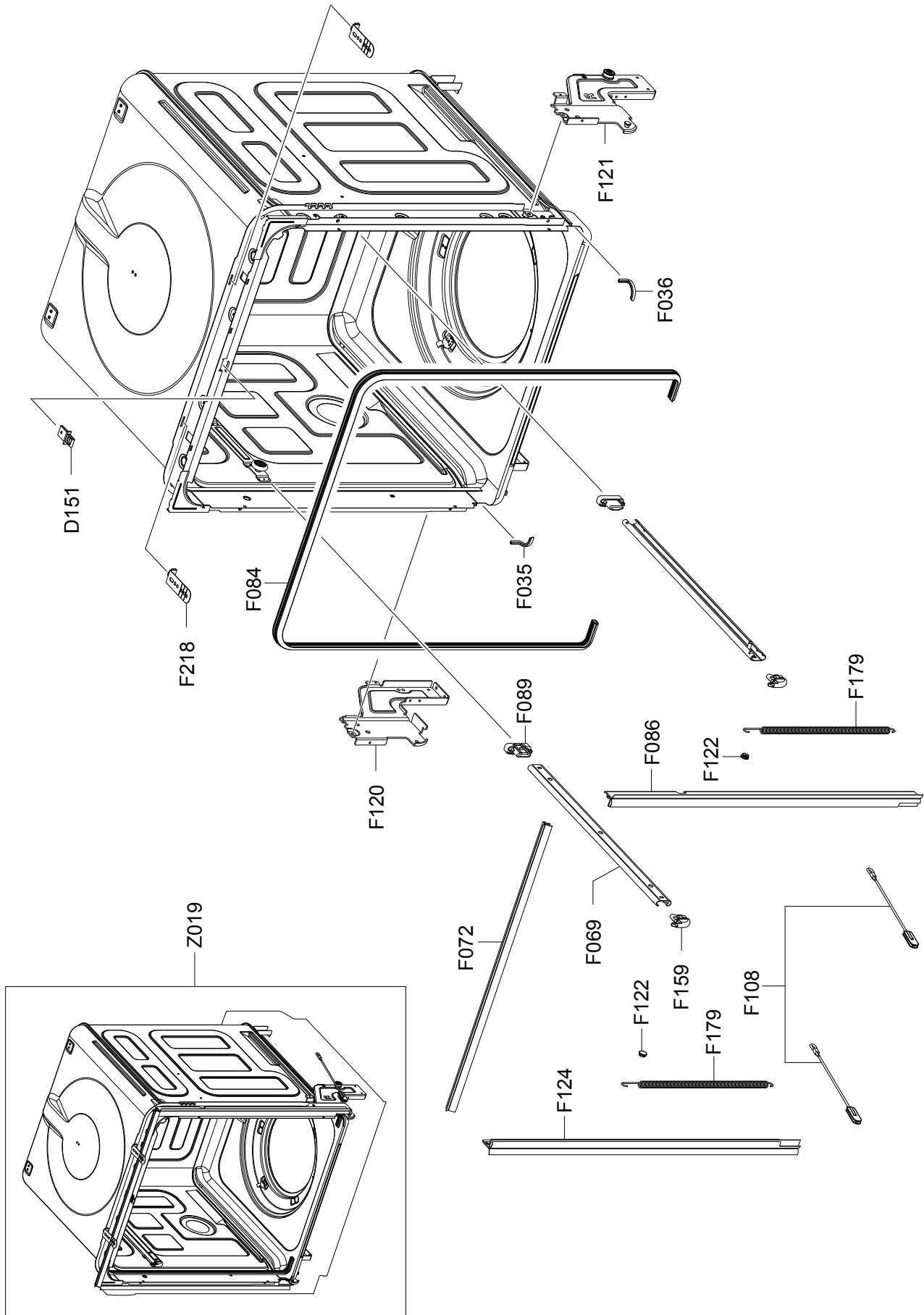

► **MODEL CODE: DMR57LF***

Service Bom (SA: SERVICE AVAILABLE, SNA: SERVICE NOT AVAILABLE)

SVC_ Code	Code No.	Description	Specification	QTY	SA/SNA	Remark
F121	DD97-00114A	ASSY-SUPPORT LINK(R)	DM1477,R-PJT	1	SA	
F120	DD97-00115A	ASSY-SUPPORT LINK(L)	DM1477,R-PJT	1	SA	
P218	DD61-00176A	BRACKET-INSTALL	DM1477,GI,T0.8,-,-,-,R-P	2	SA	
F122	DD67-00040A	CAP-TUB SPACER	DM1477,POM,-,-,-,GRY,R-PJ	2	SA	
F036	DD61-00177A	GUIDE-TUB EDGE(R)	DM1477,PP+T20%,-,-,-,G	1	SA	
F035	DD61-00178A	GUIDE-TUB EDGE(L)	DM1477,PP+T20%,-,-,-,G	1	SA	
D151	DD61-00175A	HOLDER-DOOR LOCK	DM1477,AL,-,-,-,R-PJT	1	SA	
F086	DD69-00015A	PACKING-NOISE SIDE(R)	DM1477,PVC,-,-,-,-	1	SA	
F124	DD69-00016A	PACKING-NOISE SIDE(L)	DM1477,PVC,-,-,-,-	1	SA	
F072	DD69-00014A	PACKING-NOISE TOP	DM1477,PVC,-,-,-,-,B	1	SA	
F069	DD61-00174A	RAIL-BASKET	DM1477,STS304,T0.8,-,-,-,R-P	2	SA	
F108	DD67-00039A	ROPE-DOOR SPRING	DM1477,POM/POLYESTER/S2	2	SA	
F084	DD62-00043A	SEAL-TUB FRONT	DM1477,EPDM,BLK,-,-,-,R-P	1	SA	
F159	DD61-00182A	STOPPER-RAIL(F)	DM1477,POM,-,-,-,GRAY,R-	2	SA	
F089	DD61-00183A	STOPPER-RAIL(R)	DM1477,POM,-,-,-,GRAY,R-	2	SA	
F179	DD61-00245A	SPRING ETC	DM1477,PWR,-,-,-,-,-,-,R-	2	SA	
Z019	DD97-00113A	ASSY-TUB	DM1477,R-PJT	1	SNA	

5-10. ASSY-BASE (DMR57)

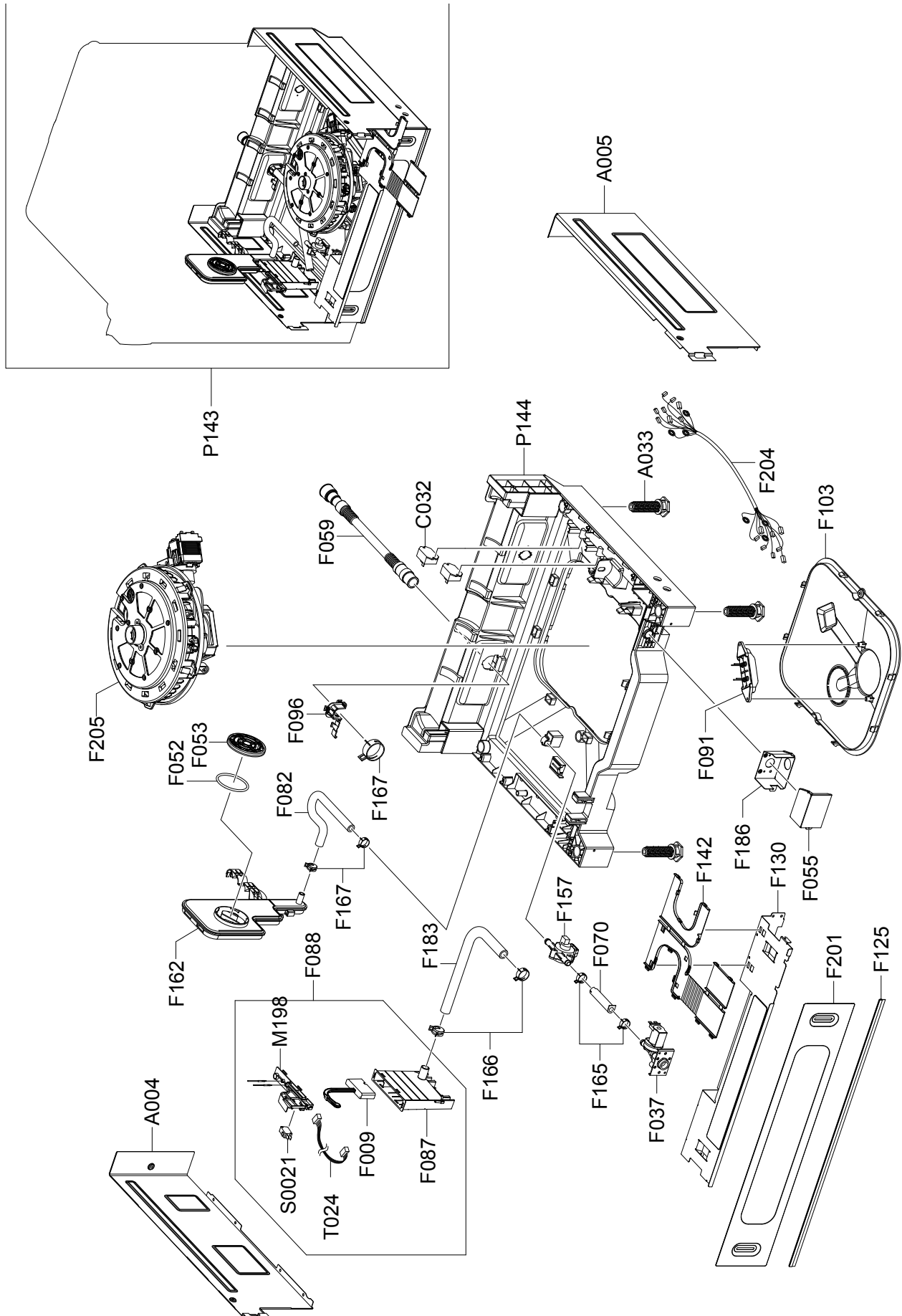

► **MODEL CODE: DMR57LF***

Service Bom (SA: SERVICE AVAILABLE, SNA: SERVICE NOT AVAILABLE)

SVC Code	Code No.	Description	Specification	QTY	SA/SNA	Remark
F091	DD97-00130A	ASSY-SENSOR LEAK	DM1477,R-PJT	1	SA	
F088	DD97-00131A	ASSY-SENSOR LEVEL	DM1477,R-PJT	1	SA	
F103	DD64-00055A	SHUTTER	DM1477,PP,-,-,-,WHT,R-PJT	1	SA	
P143	DD97-00138A	ASSY-BASE	DM1475,R-PJT/BETTER	1	SNA	
F162	DD97-00132A	ASSY-CASE BRAKE	DM1477,R-PJT	1	SA	
A033	DD61-00232A	LEG-ADJUST	DM1477,PA,-,GRY,-,R-PJT	4	SA	
P144	DD61-00233A	BASE	DM1477,PP,-,-,-,GRY,R-PJT	1	SA	
F186	DD61-00229A	CASE-POWER CORD	DM1477,GI,T1.0,-,-,-,R-P	1	SA	
F167	DD65-00001G	CLAMPER HOSE	DM1477,SK5M,-,ID23.7,-,R-PJ	1	SA	
F166	DD65-00001H	CLAMPER HOSE	DM1477,SK5M,-,D19,-,R-PJT	2	SA	
F165	DD65-00001J	CLAMPER HOSE	DM1477,SK5M,-,D16,-,R-PJT	4	SA	
F053	DD63-00073A	COVER-BRAKE	DM1477,PP+T20%,-,-,-,-,GRY	1	SA	
S0021	DD34-00003A	SWITCH-MICRO	VX-01-1C22,NORMAL OPEN,-,-,-,	1	SA	
F055	DD63-00082A	COVER-POWER CORD	DM1477,GI,T0.8,-,-,-,-,	1	SA	
A004	DD61-00208A	FRAME-LEFT	DM1477,EGI,-,-,BLK,T0.7,-,-,R	1	SA	
A005	DD61-00209A	FRAME-RIGHT	DM1477,EGI,-,-,BLK,T0.7,-,-,	1	SA	
F096	DD61-00230A	HOLDER-HOSE DRAIN	DM1477,POM,-,-,-,-,R-P	1	SA	
F059	DD97-00137A	ASSY-HOSE DRAIN	DM1477,R-PJT/VANE-CHECK	1	SA	
F070	DD67-00045A	HOSE-INLET	DM1477,EPDM,-,-,-,-,BLK,R-PJT	1	SA	
F009	DD66-00034A	LEVER-FLOAT	DM1477,PP+T20%,-,-,-,-,-,R-P	1	SA	
F125	DD69-00017A	PACKING-NOISE BASE	DM1477,PVC,-,-,-,-,-,	1	SA	
F157	DD32-00004A	SENSOR-FLOW	GSGTSD1,DM1477,-,5VDC,-,-,-,-,	1	SA	
F142	DD61-00234A	GUIDE-WIRE	DM1477,PP,-,-,-,-,R-PJT	1	SA	
T024	DD96-00043A	ASSY-WIRE HARNESS	DM1477/DM1475,OVER FLO	1	SA	
F141	DD96-00040A	ASSY-M.WIRE HARNESS	DM1475,FRONT TYPE	1	SA	
F037	DD62-00067A	VALVE-WATER	DM1477,PP,120V,-,-,-,-	1	SA	
C032	3501-000260	RELAY-POWER	12V,4400VA,20000MA,-,20MS,10	2	SA	
F130	DD61-00231A	BRACKET-FRONT LOWER	DM1477,GI,T1.0,-,-,-,-	1	SA	
F082	DD67-00046A	HOSE-INLET FLOW	DM1477,EPDM,-,-,-,-,BLK,	1	SA	
F183	DD67-00047A	HOSE-SENSOR	DM1477,EPDM,-,-,-,-,BLK,R-PJ	1	SA	
F080	DD97-00111B	ASSY-SUMP	DM1475,R-PJT/BETTER	1	SA	
F087	DD61-00236A	CASE-SENSOR	DM1477,PP,-,-,-,-,R-PJT	1	SA	
M198	DD63-00083A	COVER-SENSOR	DM1477,PP+T20%,-,-,-,-,-,	1	SA	
F201	DD63-00081A	COVER-FRONT LOWER	DM1477,EGI,T0.5,-,-,-,-,-,R-PJT	1	SA	DMR57LFS
F213	DD63-00081B	COVER-FRONT LOWER	DMR77LHB,EGI,T0.5,-,-,-,-,-,BLK,R-PJT	1	SA	DMR57LFB
F148	DD63-00081C	COVER-FRONT LOWER	DMR77LHW,EGI,T0.5,-,-,-,-,-,WHT,R-PJT	1	SA	DMR57LFW
F052	DD63-00072A	GASKET-BRAKE	DM1477,EPDM,-,-,-,-,BLK,-,R-P	1	SA	
M019	3601-000438	FUSE-CARTRIDGE	250V,15A,SLOW-BLOW,CERAMIC,6.35x31.8mm	1	SA	

5-11. ASSY-SUMP (DMR57)

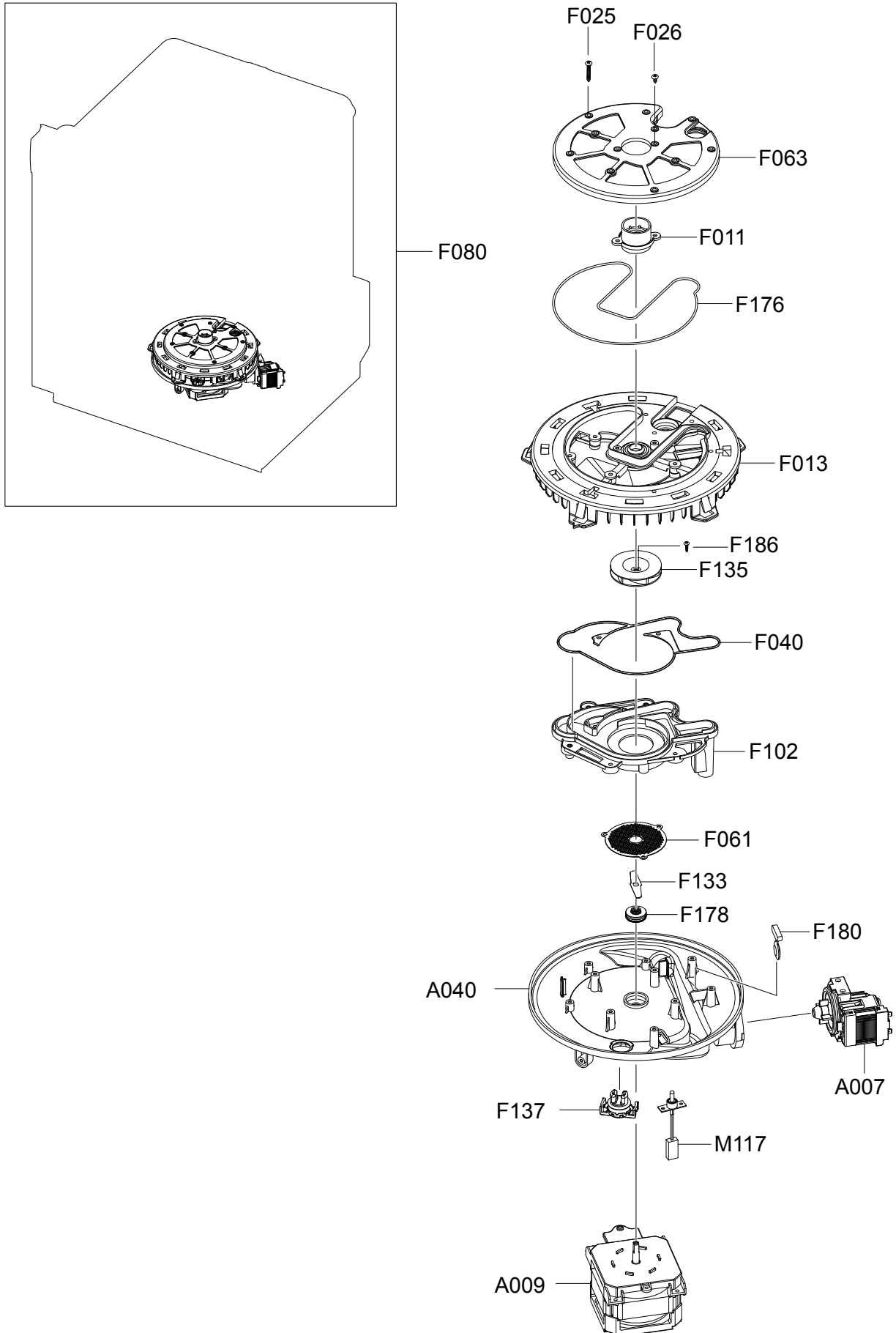

► **MODEL CODE: DMR57LF***

Service Bom (SA: SERVICE AVAILABLE, SNA: SERVICE NOT AVAILABLE)

SVC_Code	Code No.	Description	Specification	QTY	SA/SNA	Remark
F063	DD97-00133A	ASSY-FILTER MESH	DM1477,R-PJT	1	SA	
F135	DD97-00136A	ASSY-IMPELLER	DM1477,R-PJT	1	SA	
F013	DD97-00134B	ASSY-COVER SUMP	DM1475,R-PJT/BETTER	1	SA	
F102	DD61-00240B	CASE-SCROLL	DM1475,PP+T20%,,-,-,R-PJT	1	SA	
F061	DD63-00087A	FILTER-CIRCULATION	DM1477,STS304,T0.8,-,	1	SA	
F011	DD61-00241A	HOLDER-NOZZLE(L)	DM1477,POM,-,-,BLU,R-	1	SA	
A007	DD31-00005A	PUMP-DRAIN	-,120V,60Hz,-,45W/R-PJT	1	SA	
A009	DD31-00004A	PUMP-CIRCULATION	-,120V,60Hz,-,3450rpm/9	1	SA	
A040	DD61-00239B	CASE-SUMP	DM1475,PP+T20%,,-,-,R-PJT/B	1	SA	
F040	DD62-00055A	SEAL-RUBBER SCROLL	DM1477,EPDM,BLK,-,-,-	1	SA	
F176	DD62-00052A	SEAL-FILTER MESH	DM1477,EPDM,BLK,-,-,-R	1	SA	
F137	DD32-00003A	SENSOR-TURBIDITY	GSGTSD1,DM1477,-,120V,-	1	SA	
F178	DD62-00053A	SEAL-OIL	DM1477,NBR,BLK,-,-,-R-PJT	1	SA	
F180	DD66-00019A	VANE-CHECK DRAIN	DM1477,EPDM,-,-,BLK,R-P	1	SA	
M117	DD32-00001A	THERMISTOR	PTM-K51F-S14,3.3K,-,0~100°C,-	1	SA	
F080	DD97-00111B	ASSY-SUMP	DM1475,R-PJT/BETTER	1	SA	
F133	DD70-01001A	CUTTER-DISPOSER	DM1477,STS304,T1.0,-,-,-	1	SA	
F026	DD81-01149A	SCREW-SUMP(S)	DMR,SUSXM7,+TH,4x20,672000	2	SA	
F025	DD81-01150A	SCREW-SUMP(L)	DMR,SUSXM7,+TH,4x56,672000	11	SA	
F186	DD81-01172A	SCREW-MOTOR IMPELLER	DMR,SUS304,+TH,4*12	1	SA	

5-12. ASSY-CASE (DMR57)

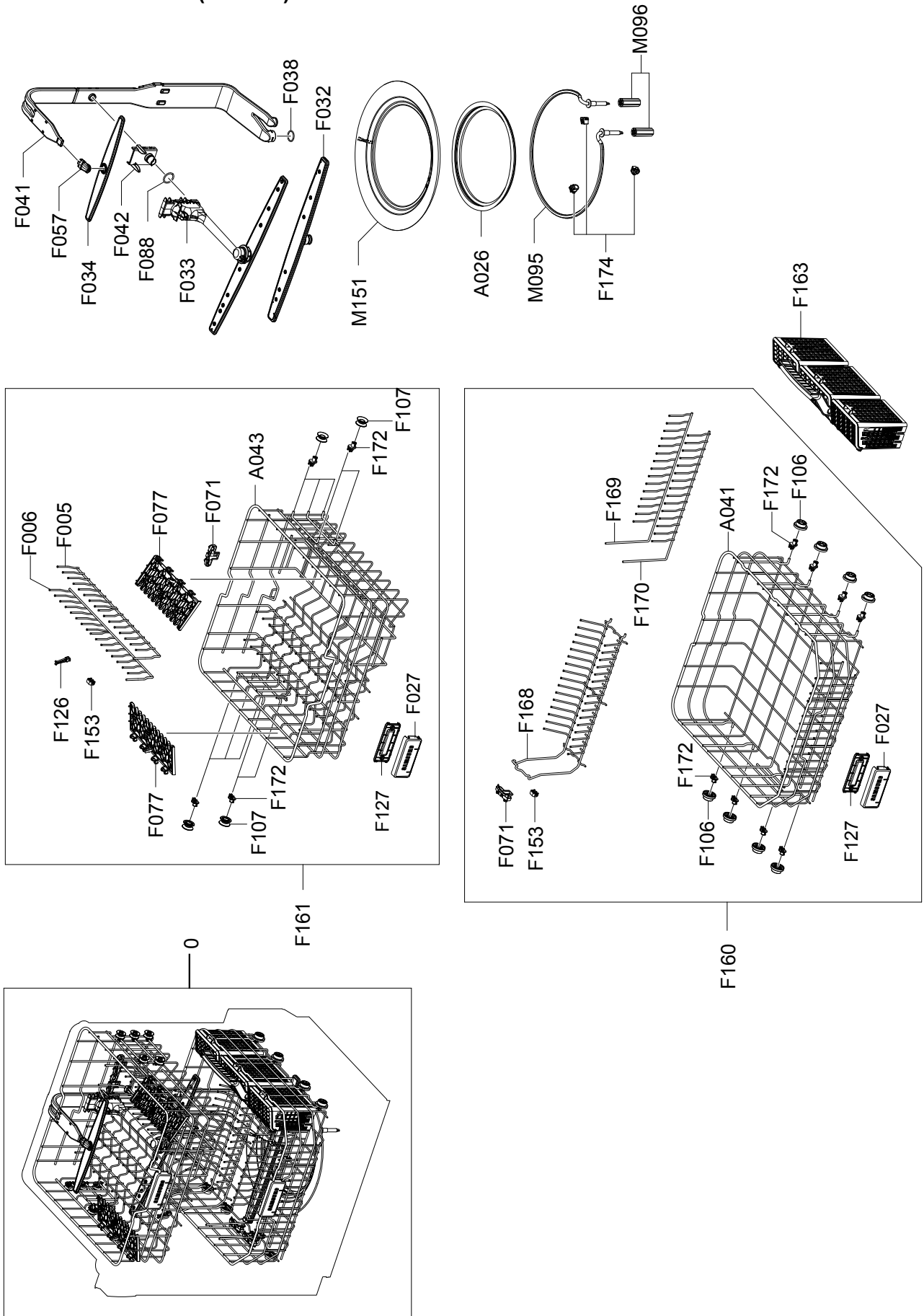

► **MODEL CODE: DMR57LF***

Service Bom (SA: SERVICE AVAILABLE, SNA: SERVICE NOT AVAILABLE)

SVC Code	Code No.	Description	Specification	QTY	SA/SNA	Remark
5.12-0	DD97-00109A	ASSY-CASE	DM1475,R-PJT/BETTER	1	SNA	
F163	DD97-00125A	ASSY-CASE SPOON	DM1477,R-PJT	1	SA	
A043	DD61-00213A	BASKET-UPPER	DM1475,HSWR,-,-,NYLON-COA	1	SA	
F041	DD67-00041A	DUCT-NOZZLE	DM1477,PP,-,-,GRY,R-PJT	1	SA	
F127	DD64-00057A	HANDLE-BASKET(L)	DMR77LHS,PP+T20%,-,-,	1	SA	
F027	DD64-00058A	HANDLE-BASKET(U)	DMR77LHS,PP+T20%,-,-,	1	SA	
F161	DD97-00118A	ASSY-BASKET UPPER	DM1475,R-PJT/BETTER	1	SA	
F034	DD97-00127A	ASSY-NOZZLE(U)	DM1477,R-PJT	1	SA	
F032	DD97-00128A	ASSY-NOZZLE(L)	DM1477,R-PJT	1	SA	
F033	DD97-00126A	ASSY-NOZZLE(M)	DM1477,R-PJT	1	SA	
A026	DD62-00050A	SEAL-SUMP	DM1477,EPDM,BLK,-,-,R-PJT	1	SA	
F160	DD97-00124A	ASSY-BASKET LOWER	DM1475,R-PJT/BETTER	1	SA	
F008	DD69-00019A	PACKING-DUCT	DM1477,EPDM,O-RING,-,-,-,	1	SA	
M095	DD47-00003A	HEATER	- ,R-PJT,INCLOY800,1100W,0.75mA	1	SA	
M151	DD63-00071A	COVER-HEATER	DM1477,STS304,T0.5,-,-,-,	1	SA	
M096	DD61-00211A	HOLDER-HEATER	DM1477,PA+GF25%,-,-,-,R-	2	SA	
F174	DD61-00212A	HOLDER-SUMP	DM1477,POM,-,-,-,R-PJT	3	SA	
F057	DD61-00228A	HOLDER-NOZZLE(U)	DM1477,POM,-,-,GRY,R-	1	SA	
F038	DD62-00068A	SEAL-DUCT NOZZLE	DMR77LHS,EPDM,BLK,T2.3,	1	SA	
F042	DD63-00069A	COVER-DUCT NOZZLE	DM1477,POM,-,-,-,G	1	SA	
F071	DD61-00216A	HOLDER-TINE	DM1477,POM,-,-,BLU,R-PJT	2	SA	
F153	DD61-00217A	HOLDER-TINE(S)	DM1477,POM,-,-,BLU,R-PJ	4	SA	
F077	DD61-00218B	SUPPORT-CUP	DM1475,POM,-,-,GRY,R-PJT	2	SA	
F126	DD61-00219A	CLIP-CUP	DM1477,POM,-,BLU,R-PJT	2	SA	
F005	DD66-00026A	WIRE-TINE UPPER(L)	DM1477,HSWR,-,-,R-PJT	1	SA	
F006	DD66-00027A	WIRE-TINE UPPER(R)	DM1477,HSWR,-,-,R-PJT	1	SA	
F107	DD66-00022A	ROLLER-BASKET(U)	DM1475,POM,-,-,GRY,-,R-	10	SA	
A041	DD61-00214A	BASKET-LOWER	DM1475,HSWR,-,-,NYLON-COA	1	SA	
F071	DD61-00216A	HOLDER-TINE	DM1477,POM,-,-,BLU,R-PJT	2	SA	
F172	DD61-00222A	HOLDER-ROLLER	DM1477,PA,-,-,GRA,R-PJT	10	SA	
F172	DD61-00222A	HOLDER-ROLLER	DM1477,PA,-,-,GRA,R-PJT	8	SA	
F106	DD66-00023A	ROLLER-BASKET(L)	DM1477,POM,-,-,GRY,-,R-	8	SA	
F168	DD66-00030A	WIRE-TINE LOWER(B)	DM1477,HSWR,-,-,R-PJT	1	SA	
F170	DD66-00031A	WIRE-TINE LOWER(R)	DM1477,HSWR,-,-,R-PJT	1	SA	
F169	DD66-00032A	WIRE-TINE LOWER(L)	DM1477,HSWR,-,-,R-PJT	1	SA	

6-2. New PBA- Main PCB

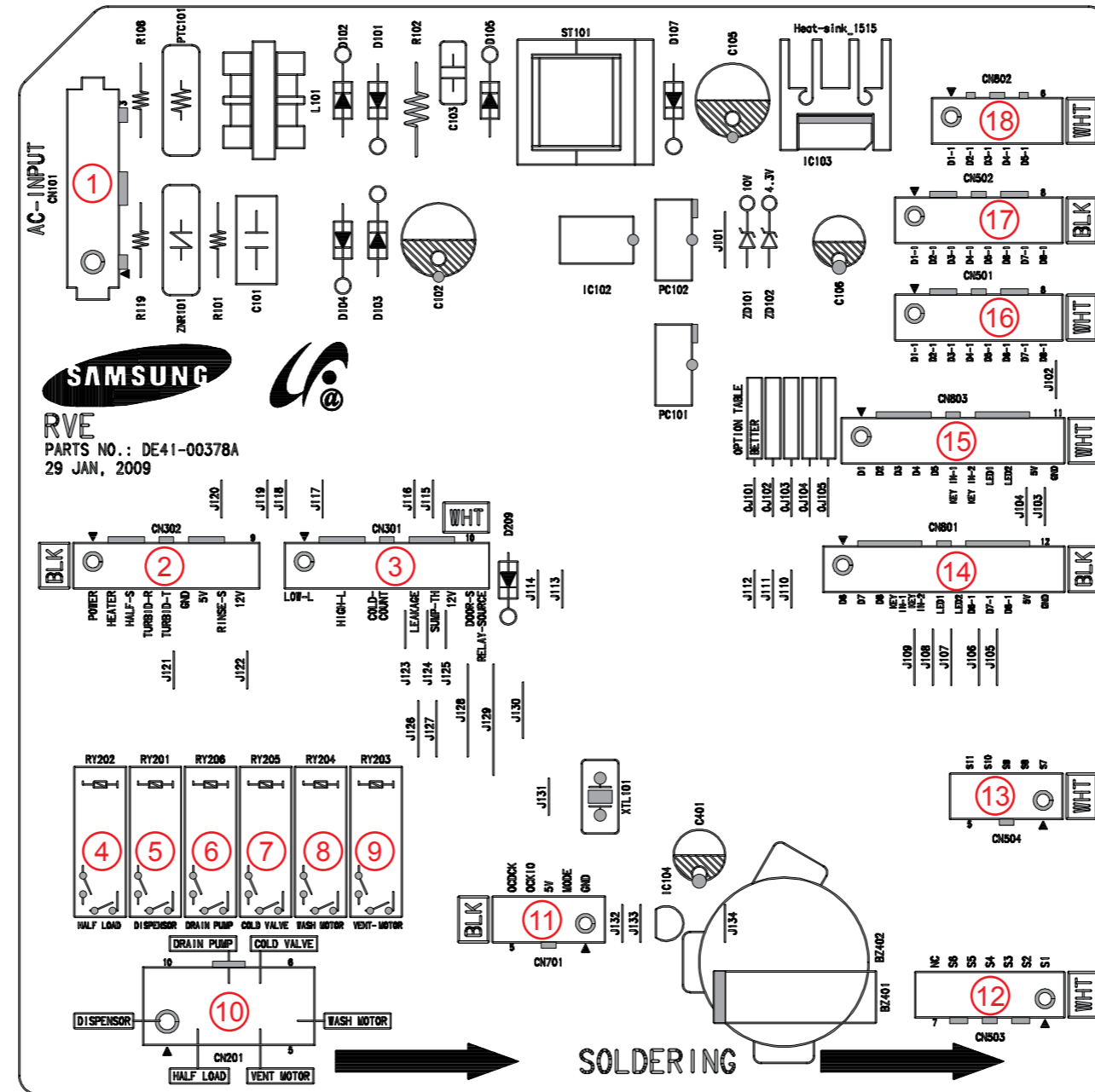

Location	Description
1	PBA Power (120V)
2	12V, DC GND, Power Relay Driver, Heater Relay Driver, Half Load Sensor, Turbidity Sensor, Rinse Aid Sensor
3	Low Water Level Sensor, Overflow Sensor, Cold Water Counter, Leakage Sensor, Temperature sensor, Door Sensor
4	Half Load Relay (only DMR77, DMR78)
5	Dispenser Driving Relay
6	Drain Pump Driving Relay

Location	Description
7	Inlet Valve Driving Relay
8	Circulation (Wash) Motor Driving Relay
9	Vent Motor Driving Relay
10	Electric Driving connector
11	Micom Writer Connector
12	Display LED Driving Connector

Location	Description
13	Display LED Driving Connector (only DMR77, DMR78)
14	Touch-Key, LED Driving, 5V, DC GND (only DMR77, DMR78)
15	Touch-Key, LED Driving, 5V, DC GND
16	Display LED Driving Connector
17	Display LED Driving Connector (only DMR77, DMR78)
18	LED, 5V Driving

6-3.Old PBA - Detailed Specifications and Descriptions for Connectors and Relay Terminals (MAIN PBA)

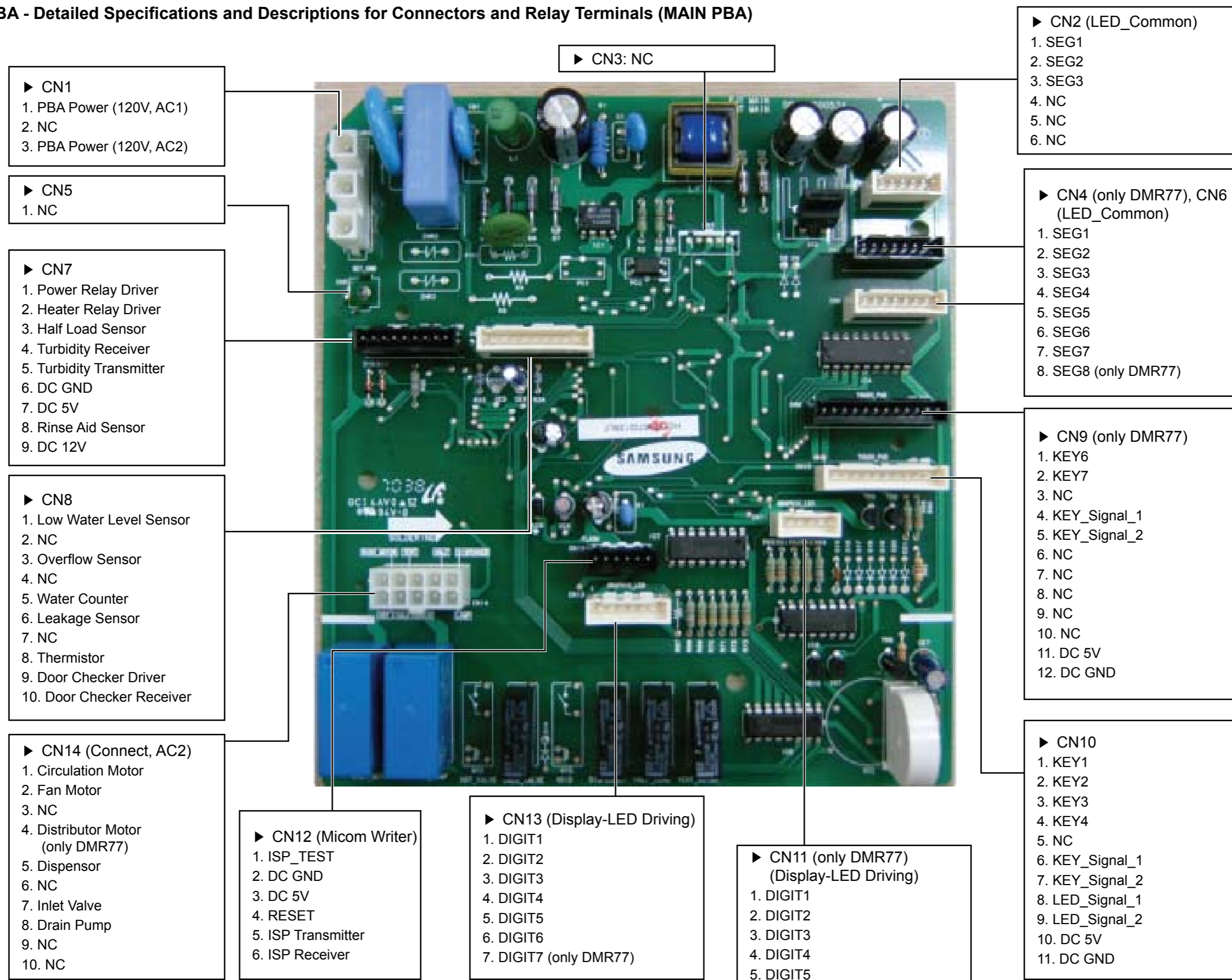

6-4. New PBA- Detailed Specifications and Descriptions for Connectors and Relay Terminals (MAIN PBA)

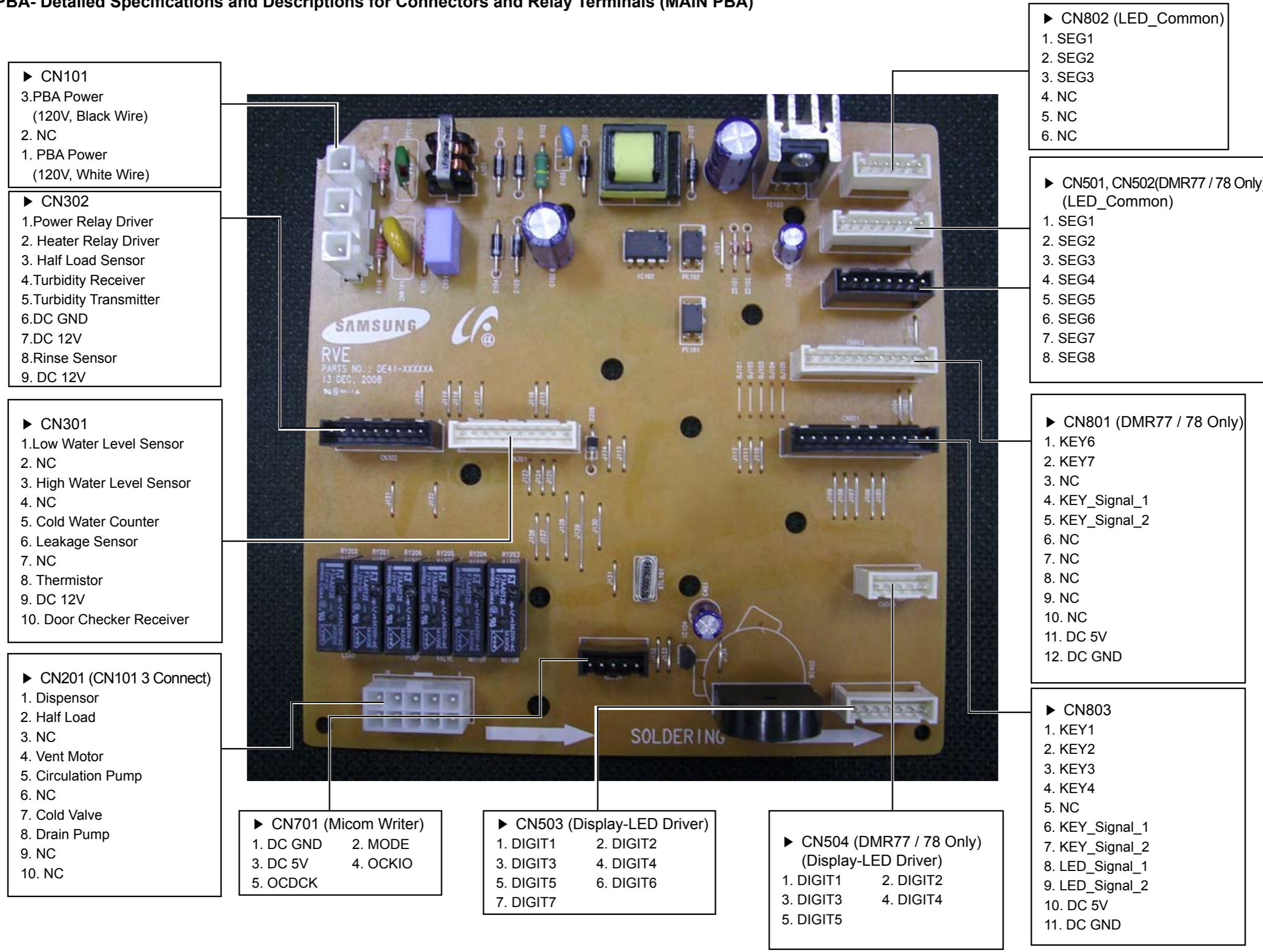

6-5. Detailed Specifications and Descriptions for Connectors (TOUCH 7KEY - DMR77, DMR78)

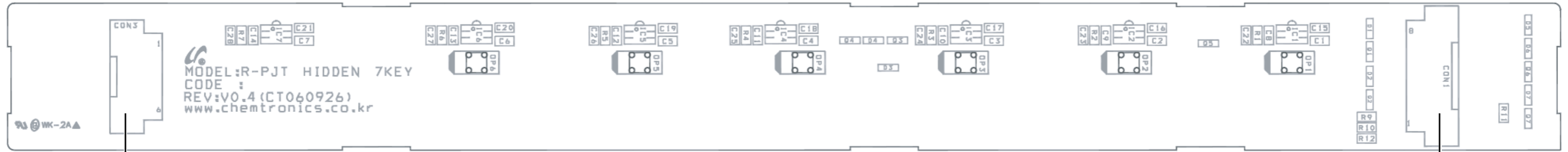

- PIN DESCRIPTIONS
1. DC 5V
 2. DC GND
 3. SEG1
 4. SEG2
 5. SEG3
 6. NC

- PIN DESCRIPTIONS
1. KEY1
 2. KEY2
 3. KEY3
 4. KEY4
 5. KEY_Signal_1
 6. KEY_Signal_2
 7. LED_Signal_1
 8. LED_Signal_2

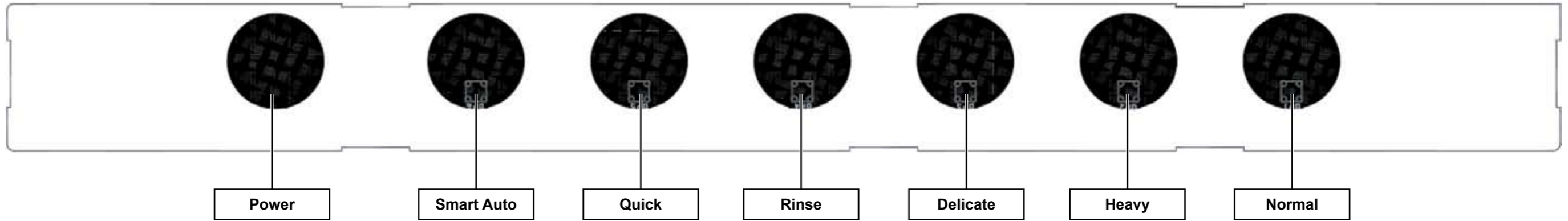

6-6. Detailed Specifications and Descriptions for Connectors (TOUCH 7KEY - DMR57)

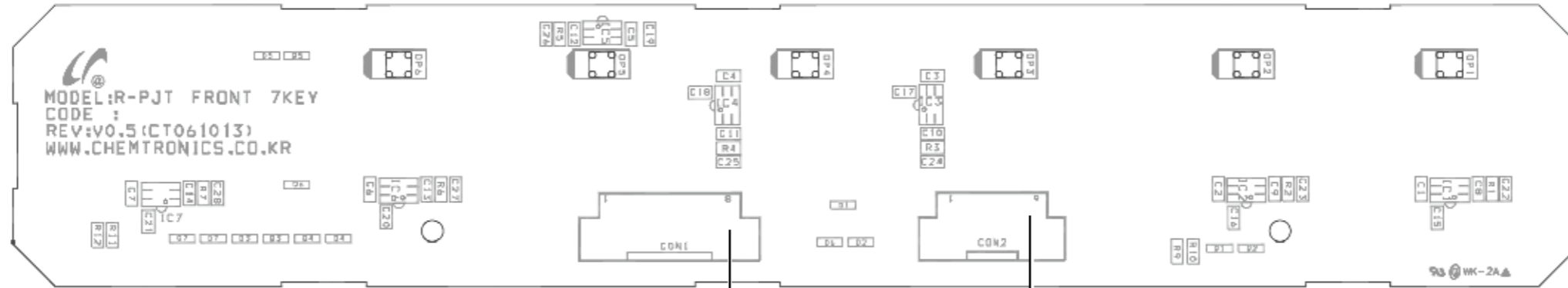
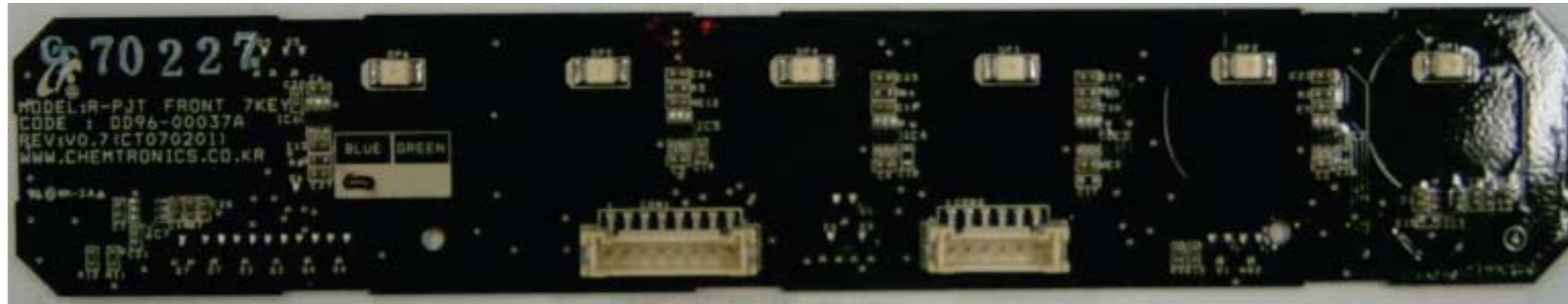

- PIN DESCRIPTIONS
- | | |
|---------|-----------------|
| 1. KEY1 | 5. KEY_Signal_1 |
| 2. KEY2 | 6. KEY_Signal_2 |
| 3. KEY3 | 7. LED_Signal_1 |
| 4. KEY4 | 8. LED_Signal_2 |

- PIN DESCRIPTIONS
- | | |
|-----------|---------|
| 1. DC 5V | 4. SEG2 |
| 2. DC GND | 5. SEG3 |
| 3. SEG1 | 6. NC |

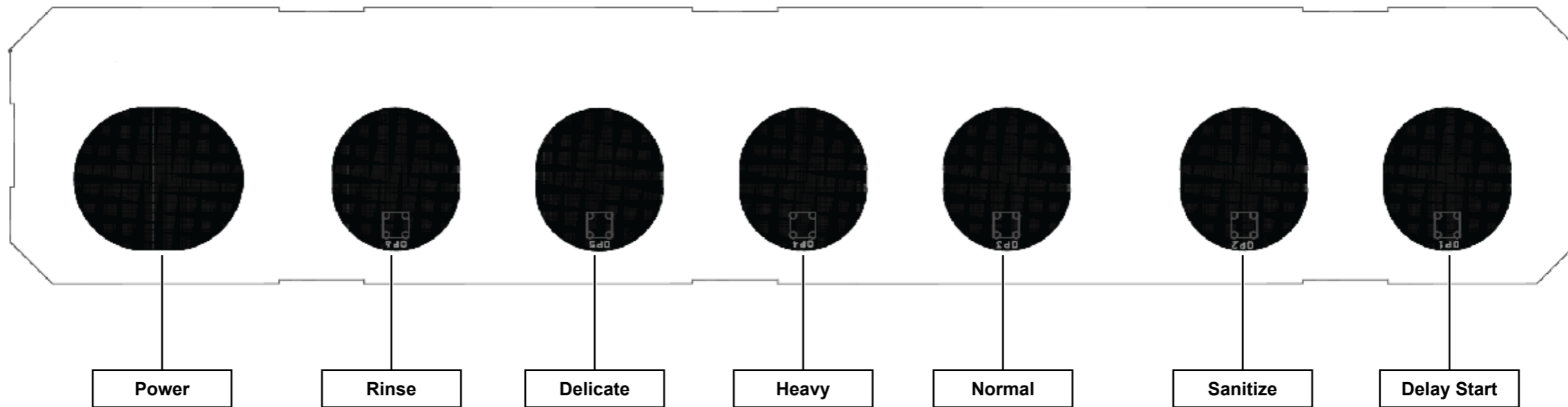

6-7. Detailed Specifications and Descriptions for Connectors (TOUCH 3KEY - DMR77,DMR78)

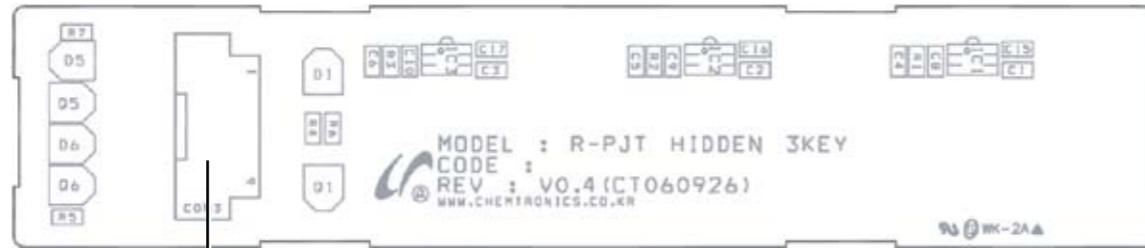

- PIN DESCRIPTIONS
1. KEY6
 2. KEY7
 3. KEY_Signal_1
 4. KEY_Signal_2
 5. DC 5V
 6. DC GND

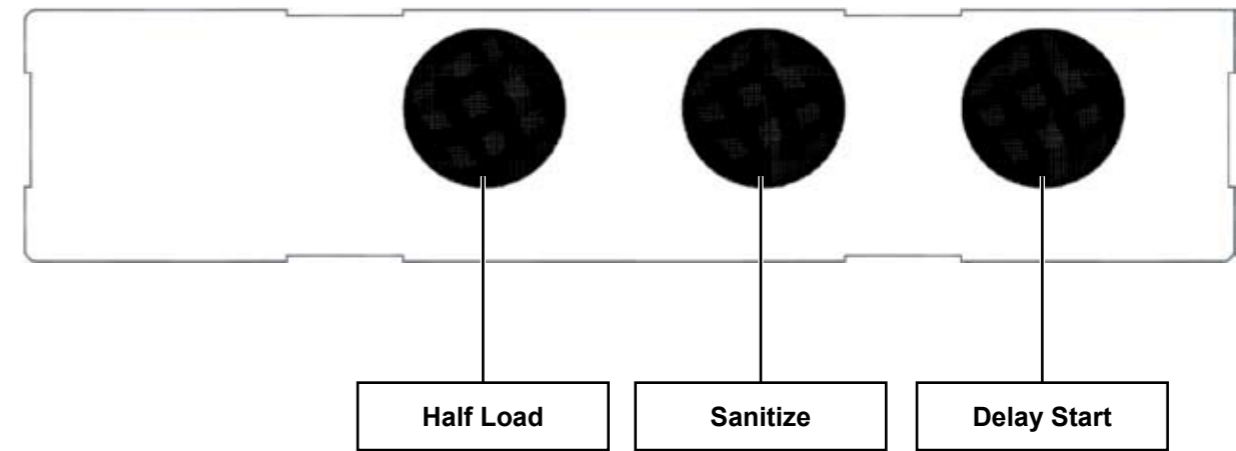

6-8. Detailed Specifications and Descriptions for Connectors (DISPLAY LED - TOP - DMR77, DMR78 (DD07-00008A, 8B))

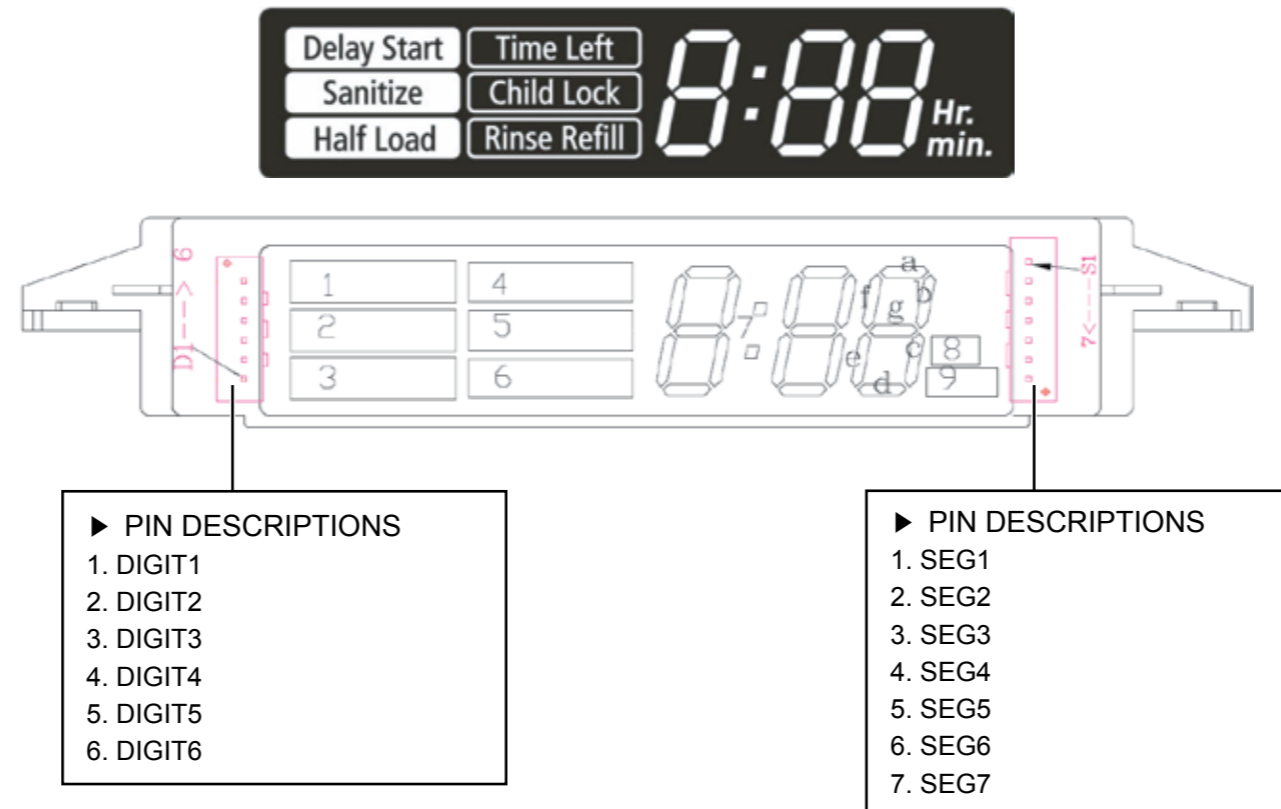

6-9. Detailed Specifications and Descriptions for Connectors (DISPLAY LED - FRONT - DMR77, DMR78 (DD07-00009A, 9B))

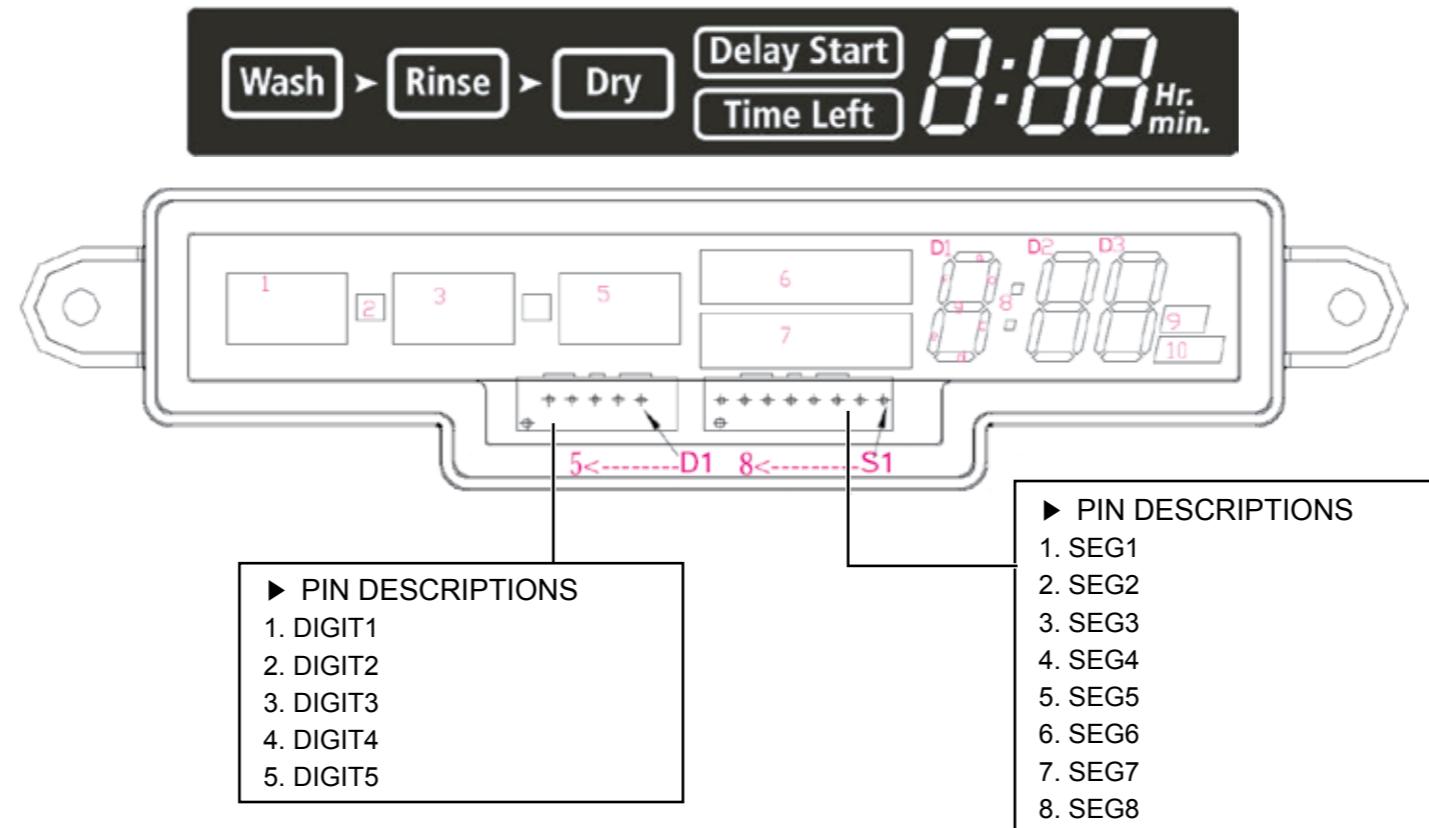

6-10. Detailed Specifications and Descriptions for Connectors (DISPLAY LED - FRONT - DMR57)

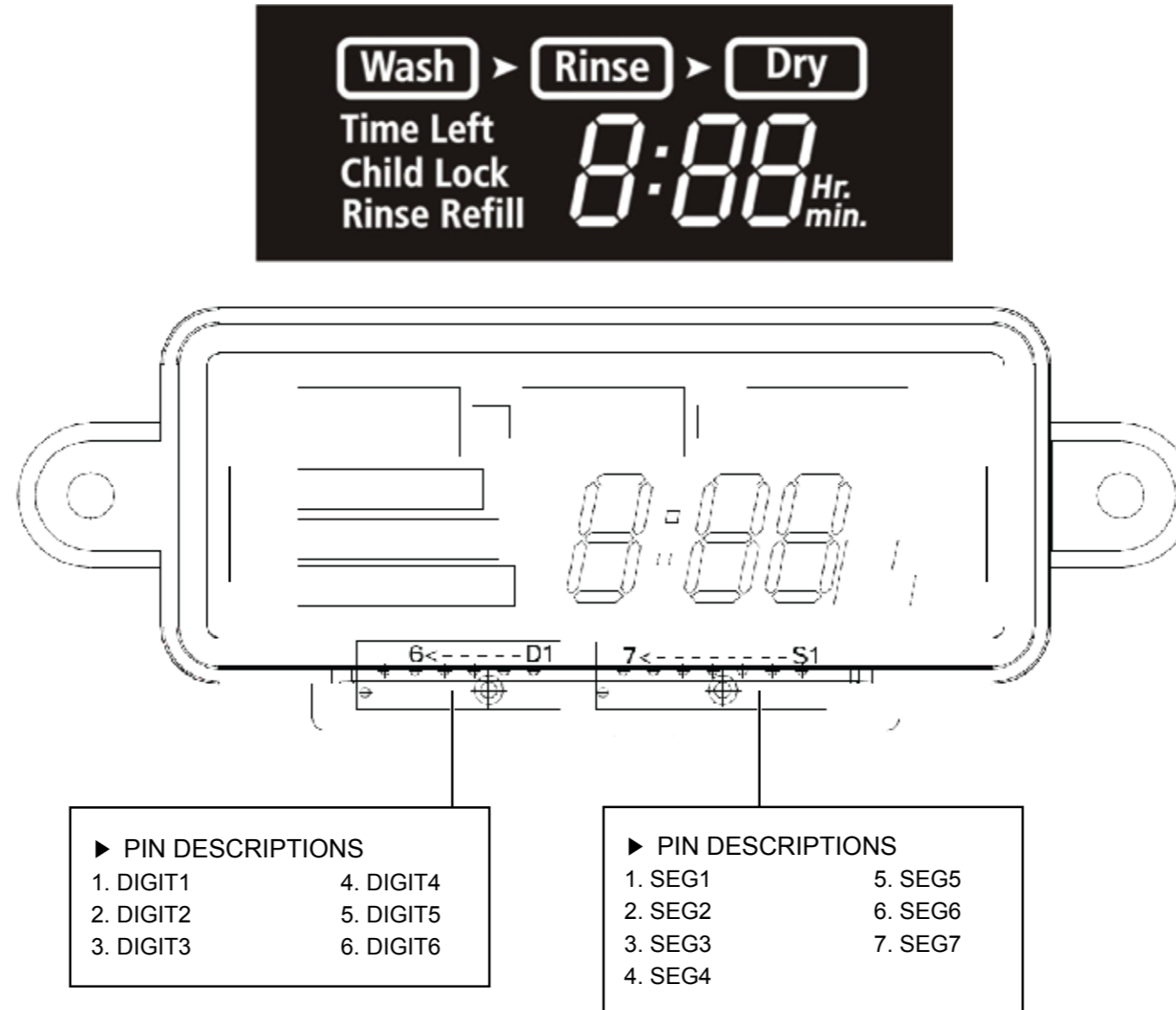

Memo

7. Wiring Diagram

7-1. Old Wiring Diagram (DMR77/78)

Reference Information

Abbreviated word	Meaning
GRY	GRAY
ORG	ORANGE
VIO	VIOLET
PNK	PINK
YEL	YELLOW
BRN	BROWN
WHT	WHITE
BLK	BLACK
RED	RED
SKY	SKY BLUE
BLU	BLUE
Y/G	YELLOW / GREEN
NTR	COLORLESS

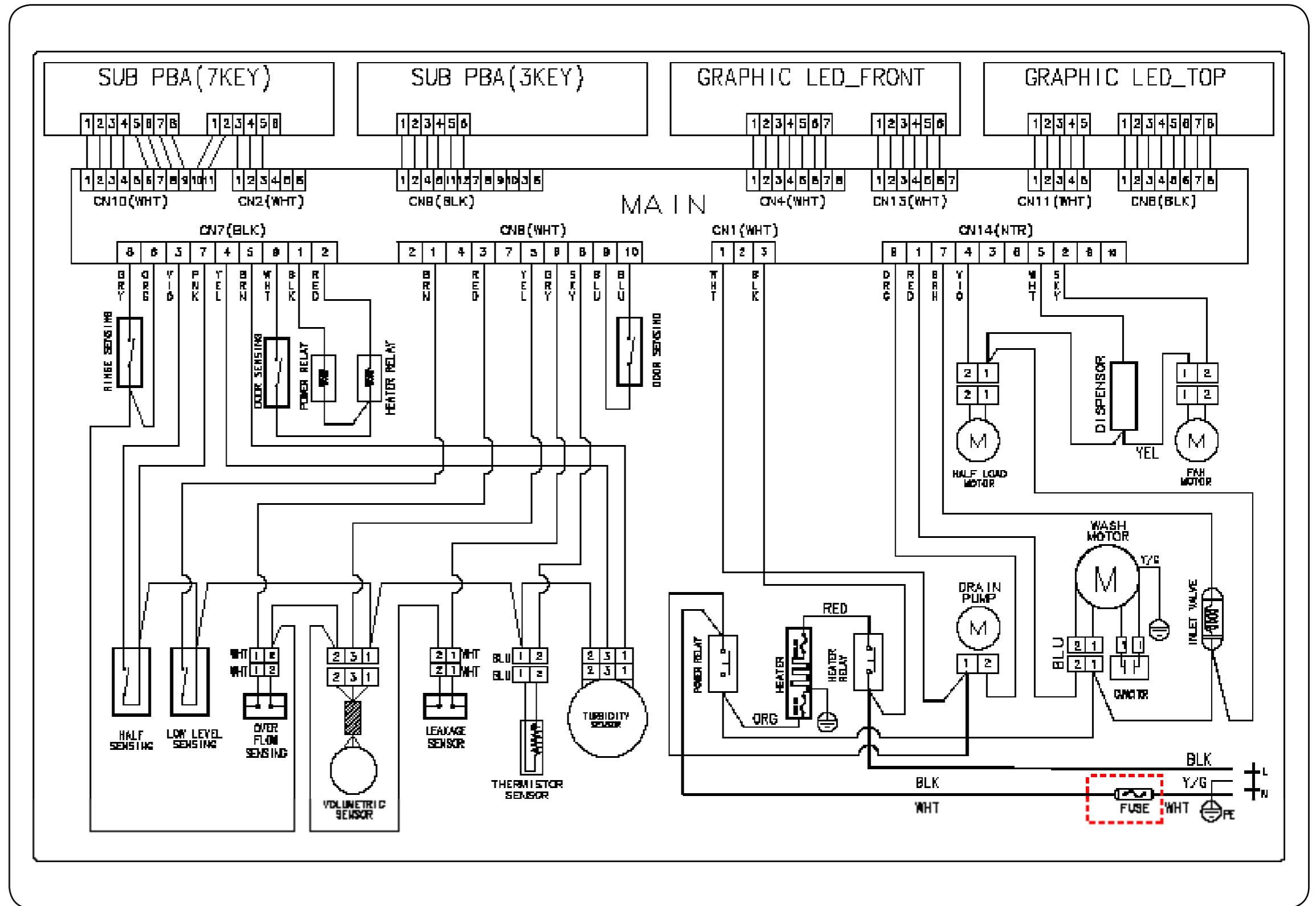

7-2. Old Wiring Diagram (DMR57)

■ Reference Information

Abbreviated word	Meaning
GRY	GRAY
ORG	ORANGE
VIO	VIOLET
PNK	PINK
YEL	YELLOW
BRN	BROWN
WHT	WHITE
BLK	BLACK
RED	RED
SKY	SKY BLUE
BLU	BLUE
Y/G	YELLOW / GREEN
NTR	COLORLESS

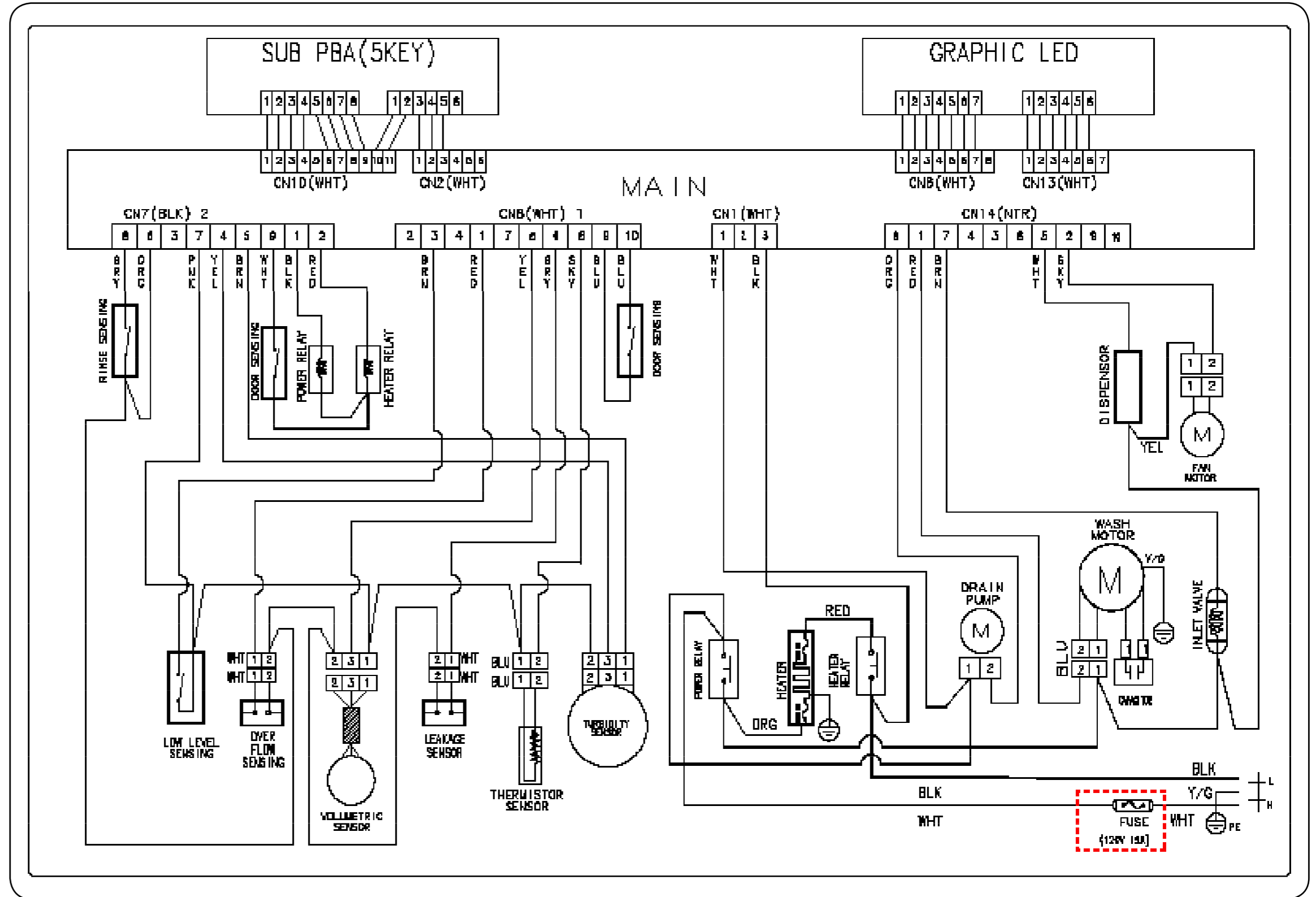

7-3. New PBA - Wiring Diagram (DMR78, DMR77 , DMR57)

■ Reference Information

Abbreviated word	Meaning
GRY	GRAY
ORG	ORANGE
VIO	VIOLET
PNK	PINK
YEL	YELLOW
BRN	BROWN
WHT	WHITE
BLK	BLACK
RED	RED
SKY	SKY BLUE
BLU	BLUE
Y/G	YELLOW / GREEN
NTR	COLORLESS

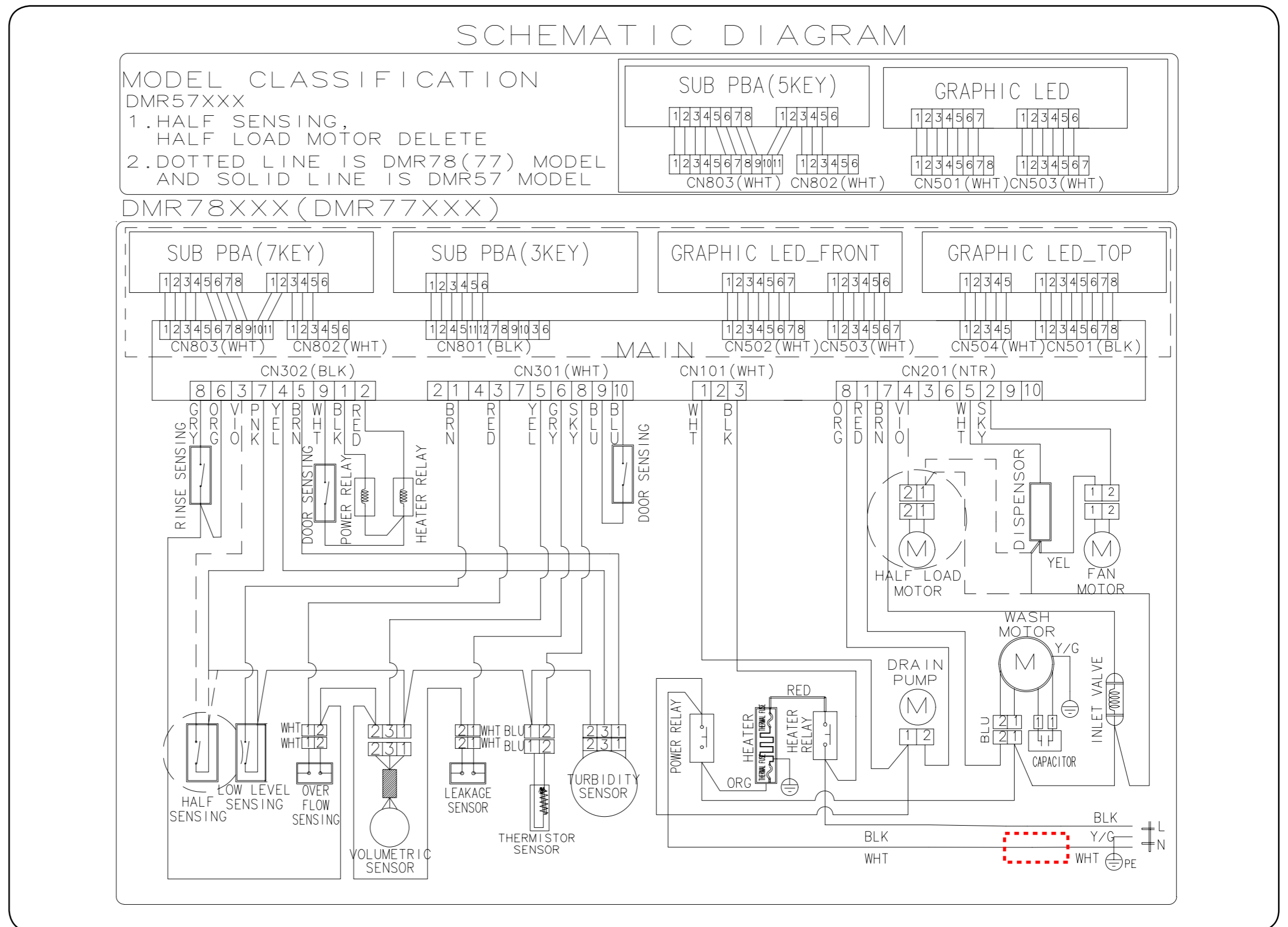

8. Schematic Diagram

8-1. MAIN CONTROL (DMR78, DMR77 , DMR57)

* This Document can not be used without Samsung's authorization.

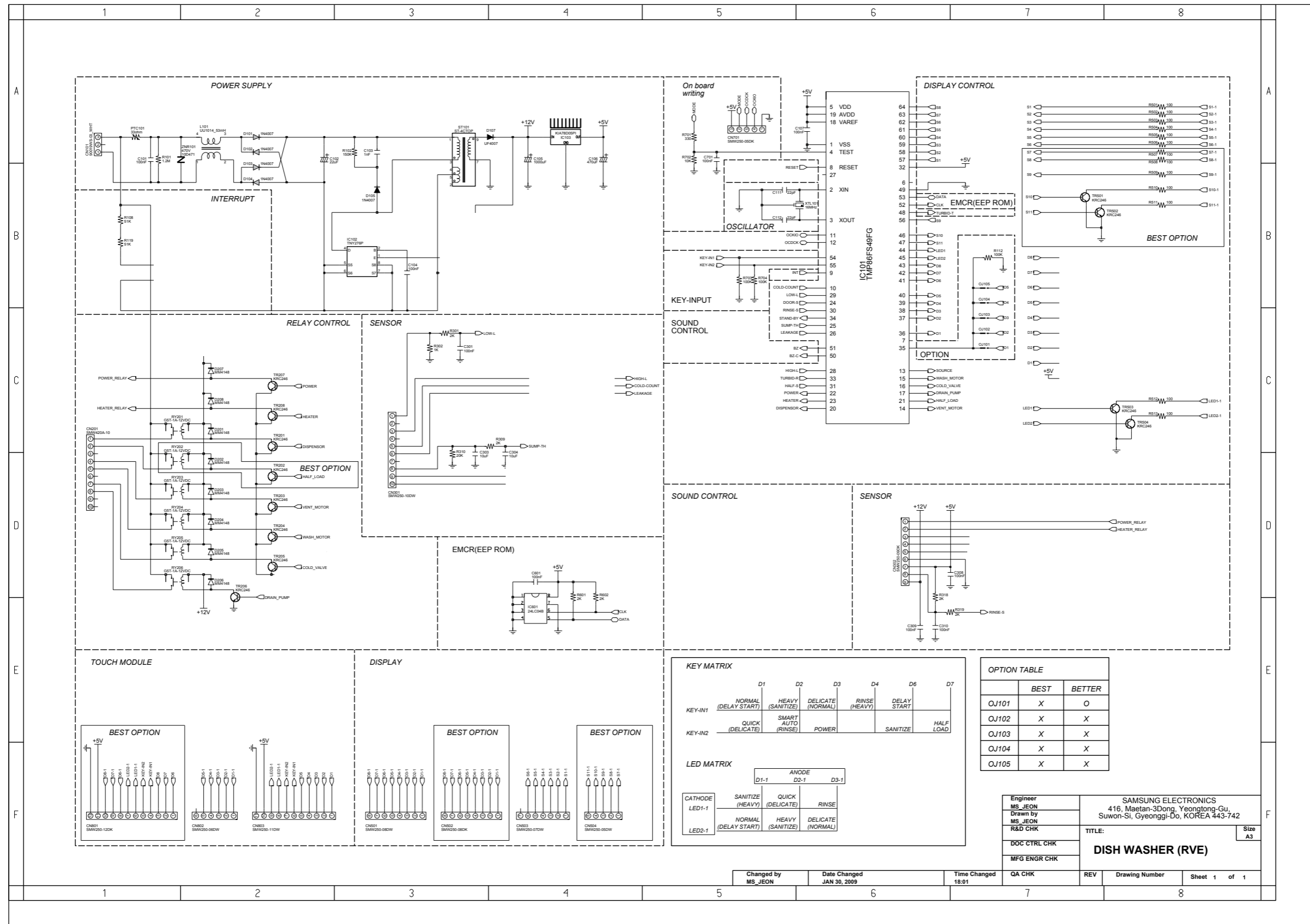

KEY MATRIX

	D1	D2	D3	D4	D6	D7
KEY-IN1	NORMAL (DELAY START)	HEAVY (SANITIZE)	DELICATE (NORMAL)	RINSE (HEAVY)	DELAY START	
KEY-IN2	QUICK (DELICATE)	SMART AUTO (RINSE)	POWER	SANITIZE	HALF LOAD	

LED MATRIX

	ANODE		
	D1-1	D2-1	D3-1
CATHODE	SANITIZE (HEAVY)	QUICK (DELICATE)	RINSE
LED1-1	NORMAL (DELAY START)	HEAVY (SANITIZE)	DELICATE (NORMAL)
LED2-1			

OPTION TABLE

	BEST	BETTER
OJ101	X	O
OJ102	X	X
OJ103	X	X
OJ104	X	X
OJ105	X	X

Engineer MS JEON	SAMSUNG ELECTRONICS 416, Maetan-3Dong, Yeongtong-Gu, Suwon-Si, Gyeonggi-Do, KOREA 443-742	TITLE: DISH WASHER (RVE)	Size A3
Drawn by MS JEON			
R&D CHK			
DOC CTRL CHK	REV	Drawing Number	Sheet 1 of 1
MFG ENGR CHK	QA CHK		

Changed by MS JEON	Date Changed JAN 30, 2009	Time Changed 16:01
-----------------------	------------------------------	-----------------------

8-3. TOUCH KEY (7KEY - DMR77, DMR78)

* This Document can not be used without Samsung's authorization.

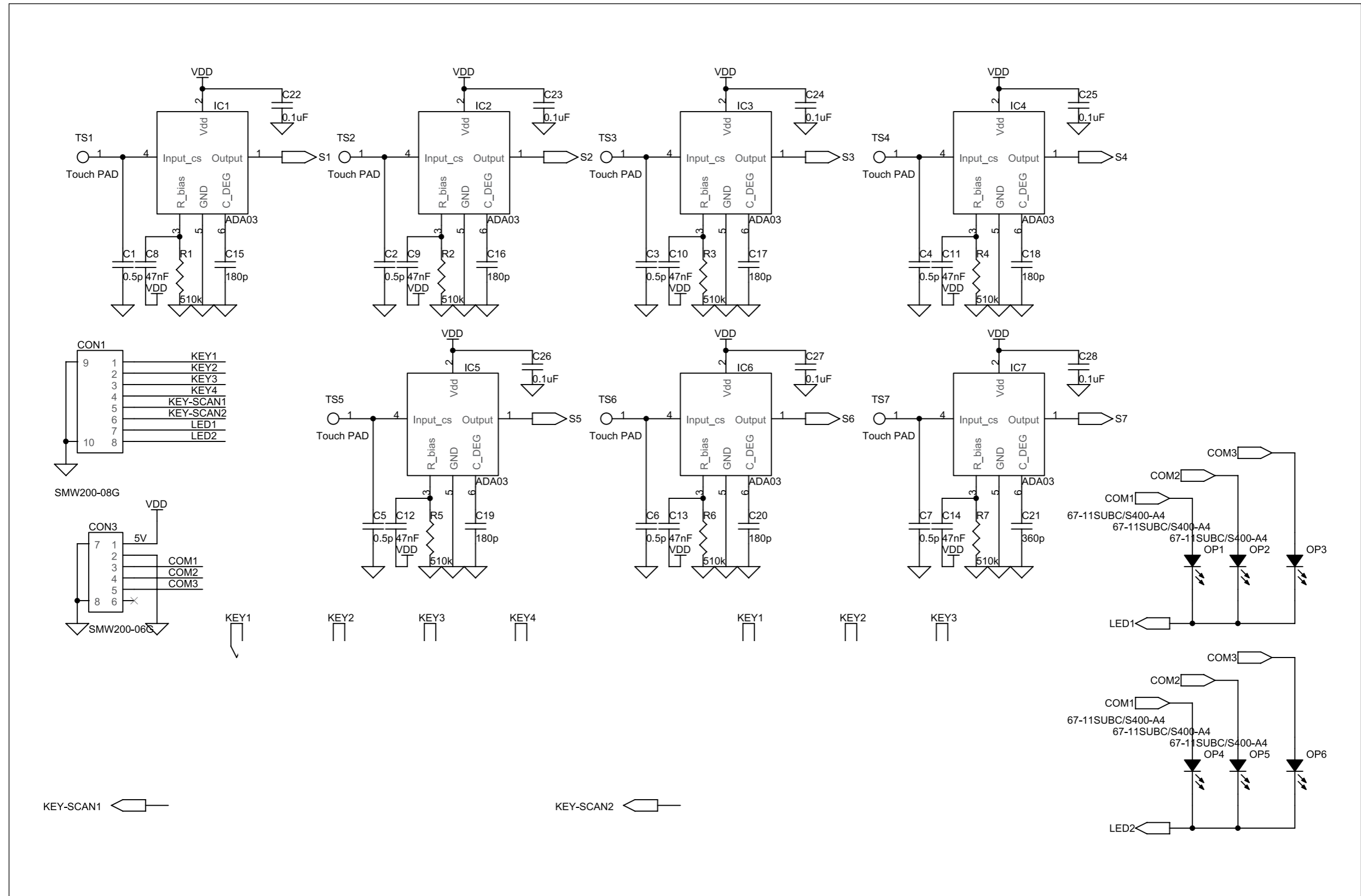

8-4. TOUCH KEY (3KEY - DMR77, DMR78)

* This Document can not be used without Samsung's authorization.

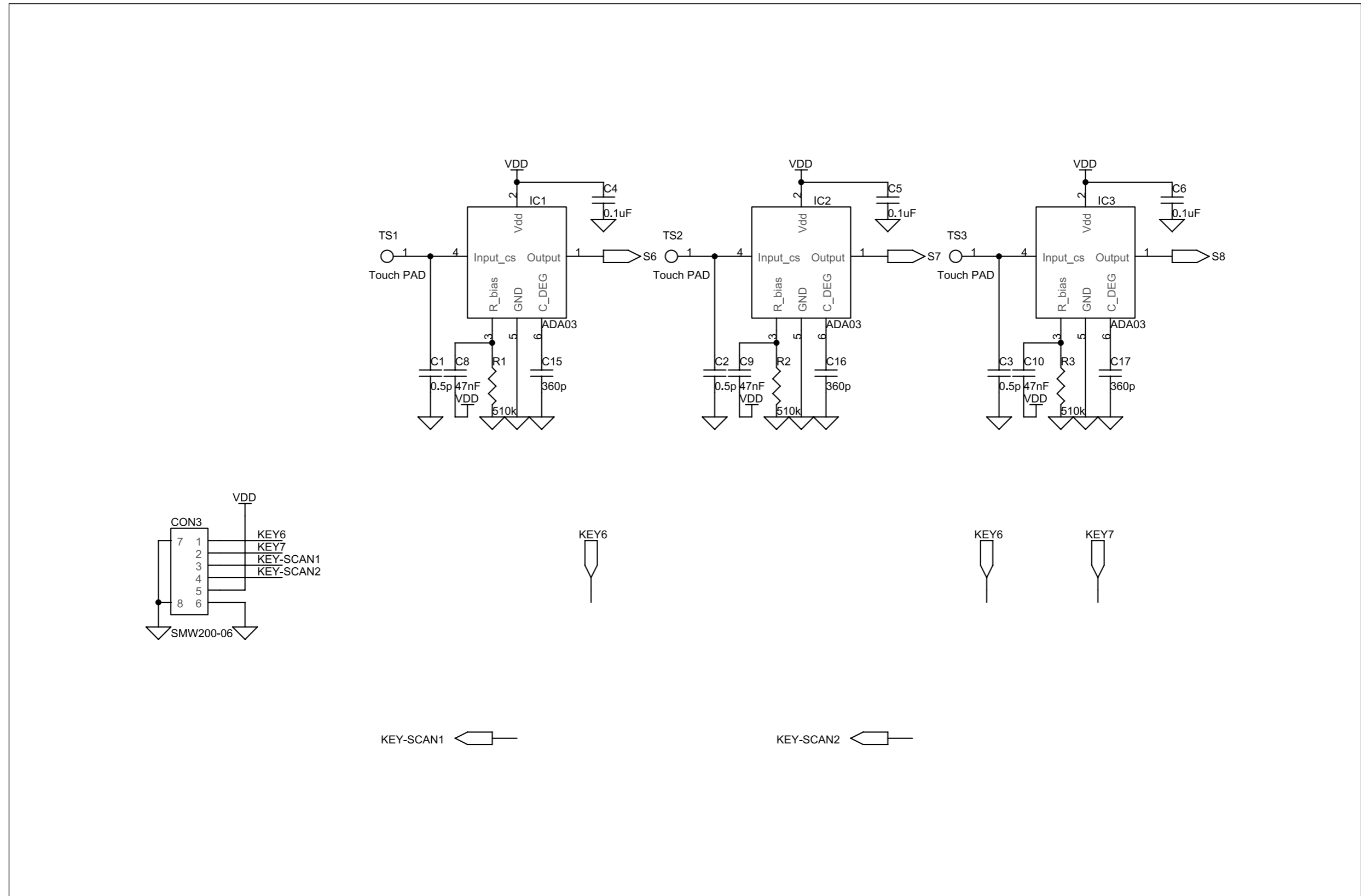

8-5. TOUCH KEY (7KEY - DMR57)

* This Document can not be used without Samsung's authorization.

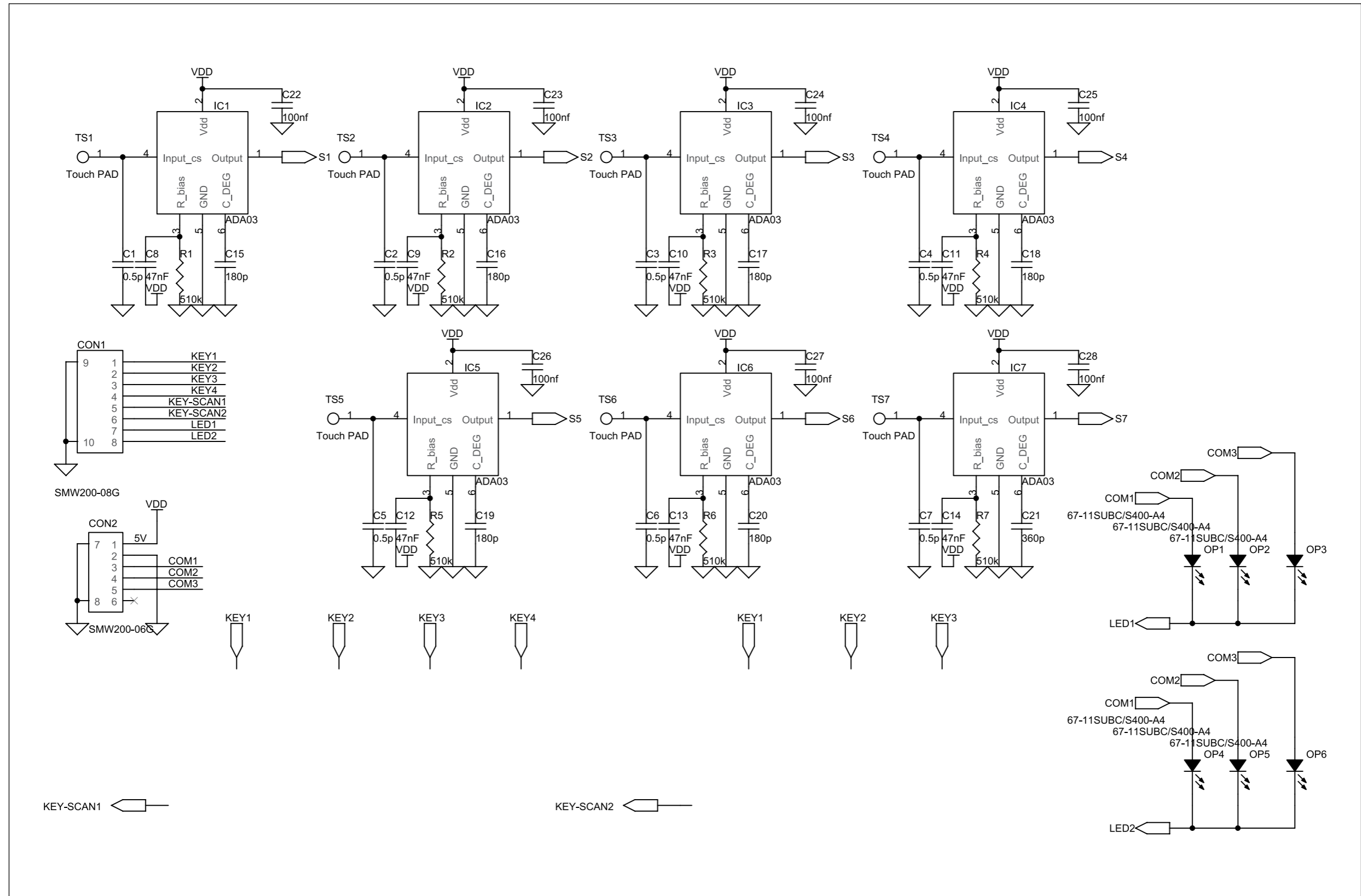

Memo

9. Reference

9-1. Model Number Naming Rules

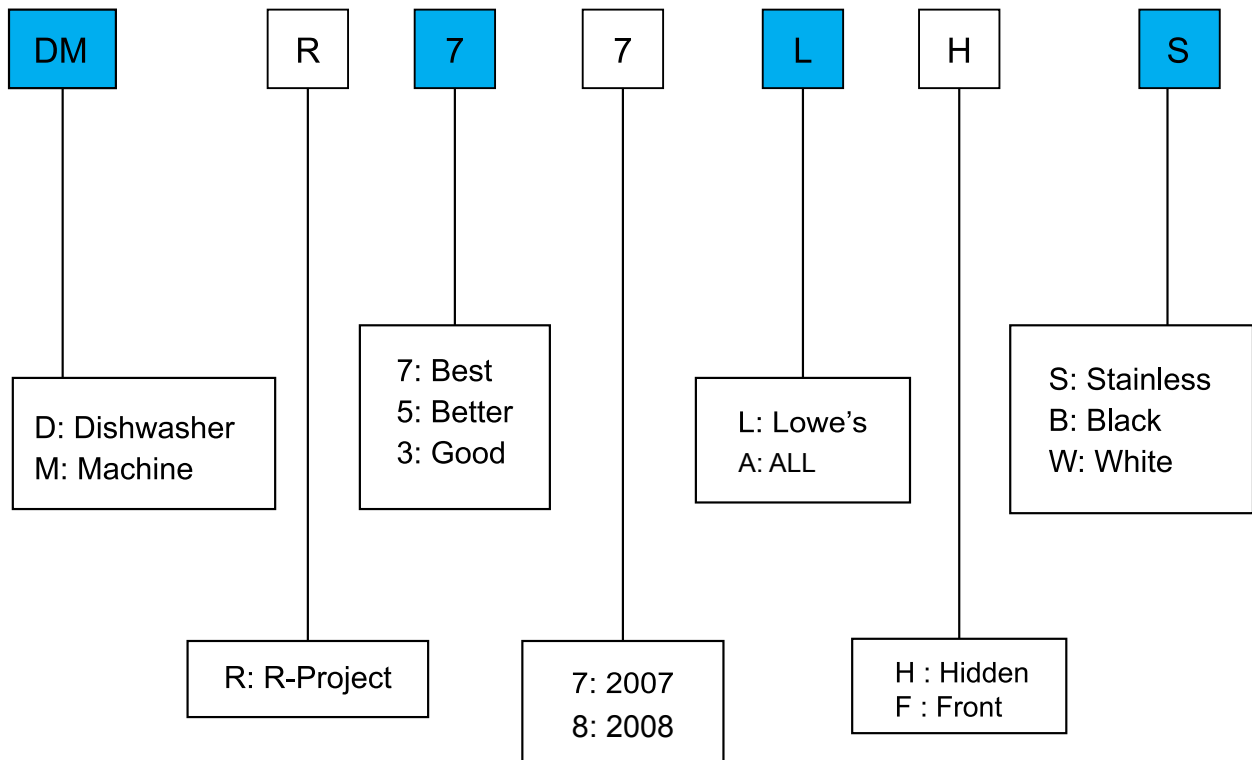

9-2. Terminology

1. Circulation Motor
 - A motor that sucks the water remaining on the floor of the dishwasher and injects water using high pressure through the internal water passages to the top, middle and lower nozzles.
2. Drain Pump
 - The pump that drains the polluted water from the dishwasher generated while the dishwasher is running.
3. Heater
 - The heater is located on the water passages inside the dishwasher. It heats the flowing water to increase wash efficiency.
4. Vent Fan
 - Drains high temperature moisture out of the dishwasher during the drying cycle (drying the dishes).
5. Flow Meter
 - Measures the amount of supplied water by counting the pulses of the hall IC located at the next of the Inlet valve.
6. Distributor
 - Located at the output end of the sump inside the dishwasher. It turns the flow of the water that goes to the bottom part of the dishwasher on or off.
7. Dispenser
 - The location where the detergent and rinse aids are stored so they can be used by the dishwasher. The dispenser automatically supplies detergent and rinse aids to the inside of the dishwasher when they are needed.
8. Tub Assy
 - An internal case made of stainless steel that makes up the basic framework of the dishwasher.
9. Sump Assy
 - The place inside the dishwasher where water is collected. The injected water gathers here after circulation. The sump Assy is connected to the circulation motor, drain pump, and distributor motor.
10. Tub Front Assy
 - An internal case made of stainless steel that makes up the internal part of the front door.
11. Base Assy
 - A plastic part that makes up the basic bottom framework.
12. Basket Assy
 - The upper and lower racks where dishes can be loaded.
13. Top/Middle/Lower Nozzles
 - Washes dishes by rotating and injecting the supplied water through the water passages at high pressure.
14. Case Brake
 - A passage that adjusts the air pressure by connecting the pressure of the inside air which is expanded at high temperature during the wash and rinse cycles and the outside air pressure.
15. Door Lock Switch
 - Detects whether the door of the dishwasher is open or closed. If the door is open while the dishwasher is running, the cycle is temporary stopped.
16. Child Lock
 - This function is used to prevent a child from operating the dishwasher while it is running.



GSPN (Global Service Partner Network)

Area	Web Site
North America	http://service.samsungportal.com
Latin America	http://latin.samsungportal.com
CIS	http://cis.samsungportal.com
Europe	http://europe.samsungportal.com
China	http://china.samsungportal.com
Asia	http://asia.samsungportal.com
Mideast & Africa	http://mea.samsungportal.com

This Service Manual is a property of Samsung Electronics Co.,Ltd.
Any unauthorized use of Manual can be punished under applicable
International and/or domestic law.

© 2008 Samsung Electronics Co.,Ltd.
All rights reserved.
Printed in Korea
Code No.: DD68-00006A-01